

Installation, operation and maintenance instructions for Flowrox™ LPP-T100 peristaltic hose pump

Installation, maintenance and operating instructions



Read these instructions carefully and make sure to understand them prior to the installation, use, and servicing of this product. Keep these instructions for future use.

DISCLAIMER

ALL DRAWINGS, SPECIFICATIONS, DATA, SOFTWARE, FIRMWARE, MANUALS, INSTRUCTIONS, DOCUMENTATION OR OTHER WORKS OF AUTHORSHIP FURNISHED BY VALMET ARE COPYRIGHTED PROPERTY OF VALMET OR ITS SUPPLIERS, AND ARE TO BE USED BY CUSTOMER, PURCHASER, SUBCONTRACTOR, SUPPLIER OR OTHER AUTHORIZED PERSONS (“USERS”) ONLY FOR THE PURPOSE OF INSTALLING, OPERATING, MAINTAINING AND REPAIRING THE GOODS AND SERVICES SUPPLIED BY VALMET (“PRODUCTS”). SUCH WORKS AND DATA MAY NOT BE OTHERWISE USED OR REPRODUCED OR DISCLOSED. VALMET OR ITS SUPPLIERS RETAIN ALL RIGHT, TITLE AND INTEREST IN AND TO ITS AND THEIR INVENTIONS, DISCOVERIES, CONCEPTS, IDEAS OR OTHER INTELLECTUAL PROPERTY EMBODIED IN OR RELATED TO ITS PRODUCTS.

ANY AND ALL TRADE SECRETS, SPECIFICATIONS, DRAWINGS, DESIGNS, SOFTWARE, SAMPLES, OTHER TECHNICAL, FINANCIAL, PRODUCT, MARKETING, SALES, PRODUCTION, SUBCONTRACTING, PRICING AND OTHER CONFIDENTIAL AND/OR PROPRIETARY INFORMATION OF A PARTY PERTAINING TO THE PRODUCTS OR OTHERWISE TO THIS CONTRACT, OR TO A PARTY, ITS PRODUCTS, BUSINESSES, OPERATIONS, OR PLANS, SHALL NOT BE DISCLOSED TO ANY UNAUTHORIZED THIRD PARTY BY THE OTHER PARTY. THE RECEIVING PARTY SHALL ENSURE THAT ITS DIRECTORS, OFFICERS, EMPLOYEES AND AGENTS COMPLY WITH THE OBLIGATIONS HEREIN. UNLESS OTHERWISE AGREED TO IN WRITING BY THE PARTIES, THE PARTIES' CONFIDENTIALITY, NON-DISCLOSURE AND NON-USE OBLIGATIONS HEREIN SHALL REMAIN IN FORCE TO THE MAXIMUM TERM PERMITTED BY APPLICABLE LAW.

THIS MANUAL PROVIDES INSTRUCTIONS TO CARRY OUT CERTAIN ACTIVITIES AND IS DESIGNED AND MEANT TO GUIDE AND ASSIST PROFESSIONAL AND PROPERLY TRAINED EXPERTS IN PERFORMING THEIR FUNCTIONS. EVERYONE MUST BECOME FAMILIAR WITH ALL INSTRUCTIONS IN THIS MANUAL BEFORE ANY INSTALLATION, USE, MAINTENANCE, REPAIR OR ANY OTHER ACTIONS OF THE RESPECTIVE GOODS AND/OR SERVICES WHICH THIS MANUAL APPLIES TO. ALL INSTRUCTIONS MUST BE FOLLOWED CAREFULLY. HOWEVER, OBSERVANCE OF ANY PART OF THE INSTRUCTIONS PRESENTED IN THIS MANUAL MAY BE OMITTED IN EVENT WHEN IT IS REQUIRED OR ALLOWED BY LAW. VALMET HAS TAKEN EVERY CARE IN THE PREPARATION OF THE CONTENT OF THIS MANUAL, BUT DOES NOT MAKE ANY REPRESENTATIONS, WARRANTIES OR GUARANTEES OR, EXPRESS OR IMPLIED, AS TO THE ACCURACY OR COMPLETENESS OF THIS MANUAL.

ALL USERS MUST UNDERSTAND AND BE AWARE THAT UPDATES AND AMENDMENTS WILL BE MADE FROM TIME TO TIME TO THIS MANUAL. ALL USERS ARE OBLIGATED TO FIND OUT AND DETERMINE WHETHER THERE HAVE BEEN ANY APPLICABLE UPDATES OR AMENDMENTS TO THIS MANUAL. NEITHER VALMET NOR ANY OF ITS DIRECTORS, OFFICERS, EMPLOYEES, SUBCONTRACTORS, SUB-SUPPLIERS, REPRESENTATIVES OR AGENTS SHALL BE LIABLE IN CONTRACT, TORT OR IN ANY OTHER MANNER WHATSOEVER TO ANY PERSON FOR ANY LOSS, DAMAGE, INJURY, DEATH, LIABILITY, COST OR EXPENSE OF ANY NATURE, INCLUDING WITHOUT LIMITATION INDIRECT, INCIDENTAL, SPECIAL, CONSEQUENTIAL, PUNITIVE OR DIRECT DAMAGES AND/OR LOSSES ARISING OUT OF OR IN CONNECTION WITH THE CREATION, DELIVERY, POSSESSION AND/OR USE OF THIS MANUAL. HOWEVER, NOTHING IN THIS PARAGRAPH IS DEEMED TO EXCLUDE OR RESTRICT ANY LIABILITY WHICH CANNOT BY MANDATORY LAW BE EXCLUDED.

FLOWROX™ IS EITHER REGISTERED TRADEMARK OR TRADEMARK OF VALMET OR ITS SUBSIDIARIES OR AFFILIATES IN THE UNITED STATES AND/OR IN OTHER COUNTRIES. ALL OTHER TRADEMARKS, LOGOS, BRANDS AND MARKS DISPLAYED IN THIS MANUAL ARE PROPERTY OF THE RESPECTIVE OWNERS UNLESS STATED OTHERWISE.

Copyright © 2014-2023 Valmet Corporation. All rights reserved.

Table of Contents

1	EU DECLARATION OF CONFORMITY	4	APPENDIX A: Tightening torques for LPP-T pumps	26
1.1	Mechanical warranty for LPP-T pumps	5	APPENDIX B: Required amounts of lubricant for LPP-T hoses	27
1.2	General safety instructions for LPP-T pumps	5	APPENDIX C: Hose leak detector chart	28
2	INTRODUCTION	7	APPENDIX D: Claim form	29
2.1	Applications and purposes of use	7	APPENDIX E: Dimensions, LPP-T100 pumps	30
2.2	General description	7		
2.3	Electrical equipment	10		
2.4	Technical data	10		
3	TRANSPORTATION, STORAGE AND LIFTING	11		
4	INSTALLATION	11		
4.1	General	11		
4.2	Pump installation	12		
4.3	Electrical connection	12		
4.4	Piping connections	13		
5	PUMP OPERATION	13		
5.1	Commissioning	13		
5.2	Operation	14		
6	SERVICING AND MAINTENANCE	14		
6.1	General maintenance and checks	14		
6.2	Changing the hose	15		
6.3	Maintenance	25		
6.4	Troubleshooting	25		

READ THESE INSTRUCTIONS FIRST!

These instructions provide information about safe handling and operation of the product

If you require additional assistance, please contact the manufacturer or manufacturer's representative.

SAVE THESE INSTRUCTIONS!

Addresses and phone numbers are printed on the back cover.

1 EU DECLARATION OF CONFORMITY

This declaration of conformity is issued under the sole responsibility of the manufacturer:

VALMET FLOW CONTROL OY

Marsitie 1

53600 Lappeenranta

Finland

Tel. +358 (0)10 417 5000

Product model/type: Peristaltic Hose Pump LPP-D and LPP-T

The object of the declaration described above is in conformity with the relevant Union harmonisation legislation:

Machinery Directive 2006/42/EC: Annex II A

ATEX Directive 2014/34/EU: Non-electrical equipment

Follow the pump installation, operating and maintenance instructions in this manual.

Person authorised to compile the technical file is Technology Manager Jarmo Partanen.

On behalf of Valmet Flow Control Oy

In Lappeenranta, 13th May 2022



Riku Salojärvi

Head of Operations

1.1 Mechanical warranty for LPP-T pumps

The warranty is valid for 12 months from the delivery date, excluding the following:

- Wear parts, such as gaskets, bearings, and hoses (for requirements concerning hose manufacturing defects, see 'PUMP HOSES')
- Pumps that the first buyer has resold without a written agreement with the vendor regarding the remaining portion of the warranty period
- Direct or consequential damage caused by structural changes made to the pump or by the use of parts that are not approved by the original manufacturer

The purchaser must fill a claim for all compensation related to the hose and/or pump guarantee within 30 days after the fault has been detected. For the claim form, see Appendix F.

If the terms indicated in the claim form are not complied with, the purchaser loses his or her right to the guarantee.

The guarantee compensates for new parts if any damaged parts must be replaced. Terms of delivery: packed at the factory, with no other costs covered.

PUMP HOSES:

The hose of the pump is in contact with the pumped product and is exposed to wear, high temperatures, pressure shocks, chemicals and other wearing mechanisms. The pump hose is therefore considered a wearing part that requires periodic replacement.

Flowrox pumps have proved reliable in several demanding applications. However, the operation conditions vary to the extent that we cannot specify an exact service life or guarantee period for the hose. The guarantee applies to only manufacturing defects of the hose.

If there is a manufacturing defect, the customer is entitled to return the defective hoses to the supplier. The supplier shall reimburse the customer for the value of the hoses, excluding the freight charges, packaging costs, and other expenses, upon the following conditions:







- The pump has been used only for its intended purpose
- For all claims regarding a hose fault, the hose in question, along with a description of the operational conditions and method used, has been delivered to Valmet Flow Control Oy for chemical and mechanical analysis



Possible reimbursement for a faulty hose shall be made only after the hose examination.

1.2 General safety instructions for LPP-T pumps

In this manual, the following symbols are used to highlight the parts requiring particular attention:

Hazard severity panels.

	 DANGER!
	DANGER indicates a hazard with a high level of risk which, if not avoided, will result in death or serious injury.
	 WARNING!
	WARNING indicates a hazard with a medium level of risk which, if not avoided, could result in death or serious injury.
	 CAUTION!
	CAUTION indicates a hazard with a low level of risk which, if not avoided, could result in minor or moderate injury.

SYMBOL	DESCRIPTION
	Risk to personal safety: Neglecting the safety measures can cause serious personal injury or death.
	Electrocution hazard: Neglecting the safety measures can cause serious personal injury or death.
	Falling load hazard
	Crushing hazard
	Read the operation and maintenance instructions: Read and understand the operation and maintenance instructions before using the product.

SYMBOL	DESCRIPTION
	Mandatory action symbol: Obey these instructions to prevent machine malfunctions.

The following optional equipment is also considered safety equipment:

- Hose leak detector: stops the pump if the hose breaks
- Pressure transmitter with display and overpressure limit: stops the pump if the overpressure limit is exceeded

Obey the safety instructions of this manual to prevent accidents and to make sure the pump functions. Installation and maintenance of the pump can be done by persons with appropriate training.

The safety aspects are considered as much as possible in the design of the pump.

Never use the pump with the front cover or the inspection glass open. If the glass must be removed for certain maintenance procedures, apply extreme caution. Keep all body parts away from the danger zone.

The pump is connected to high voltage. Do not open the connection box when the drive unit is connected. Only professional electricians can do electrical work.

The pump can produce and maintain a high pressure. Prepare for this when someone opens the pipe connections etc. The pipeline can contain high pressure even after the pump stops.

Safety instructions

Unauthorised personnel are not allowed near the pump when it is in operation. The maintenance and servicing of the pump must be done by persons with appropriate training.

Always equip pumps with the safety equipment required by appropriate national regulations. Equip the pump unit power supply with at least the following electrical safety devices:

- Emergency switch
- Main switch
- Motor overload protector
- Fuses

	WARNING!
	Crushing hazard. The front cover is part of the pump's safety equipment. Never use the pump without the front cover or with the front cover open.

2 INTRODUCTION

2.1 Applications and purposes of use

The pump is intended for the following tasks:

- Pumping liquids
- Liquids containing solid matter
- Sludge
- Aggressive liquids

Normal pumping operations include the following tasks:

- Transfer
- Dosing
- Feeding
- Drainage pumping

Use for other purposes is forbidden.

The LPP-T100 peristaltic hose pump is a gasketless pump. A gasketless pump is not damaged even if it runs dry for a relatively long time. The only part of the pump in contact with the pumped medium is the hose. The hose is also the only part of the pump that needs regular replacement.

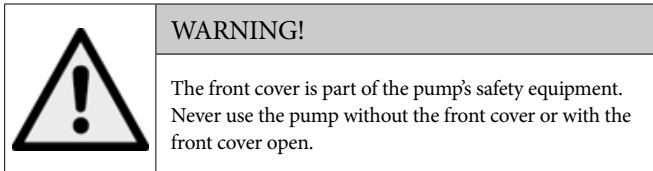

The protection class (IP) of the pump depends on the level of equipment installed. The normal protection class is IP54.

Restrictions on use for LPP-T pumps

The following restrictions on use must be taken into consideration:

LPP-T pumps operate on the displacement principle, producing a fixed displacement flow for the pumping cycle. In some applications this might cause overpressure situations that may lead to equipment damage. The operation of the pump is peristaltic. The displacement flow produced by the pump is not continuous – there is a phase in each work cycle during which the displacement flow is zero. Thus the displacement flow produced by the pump is pulsatory, which is manifested in the piping as pressure pulsation. The pulsation can be dampened by using flexible piping parts or

pulsation absorbers. Pulsation may be harmful for piping or other equipment connected to the piping.

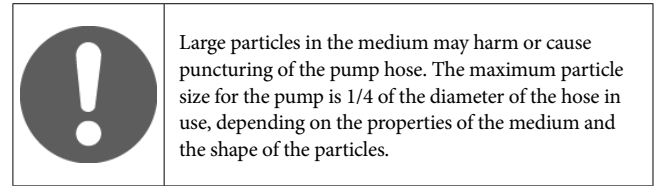

Certain chemicals (especially chemicals at high temperature) cannot be pumped, or they may significantly shorten the operating life of the hose.

2.2 General description

Principle of operation

The pump operation is based on the peristaltic effect: The cylindrical rotor, equipped with a bearing, compresses the hose during the 360-degree working cycle. The rotor pushes the pumped medium forward in the hose as it rotates.

After the rotor, the hose returns to its original shape, thus forming a vacuum within. The vacuum then refills with medium from the suction side. The backflow through the point of compression is prevented.

Mechanical structure

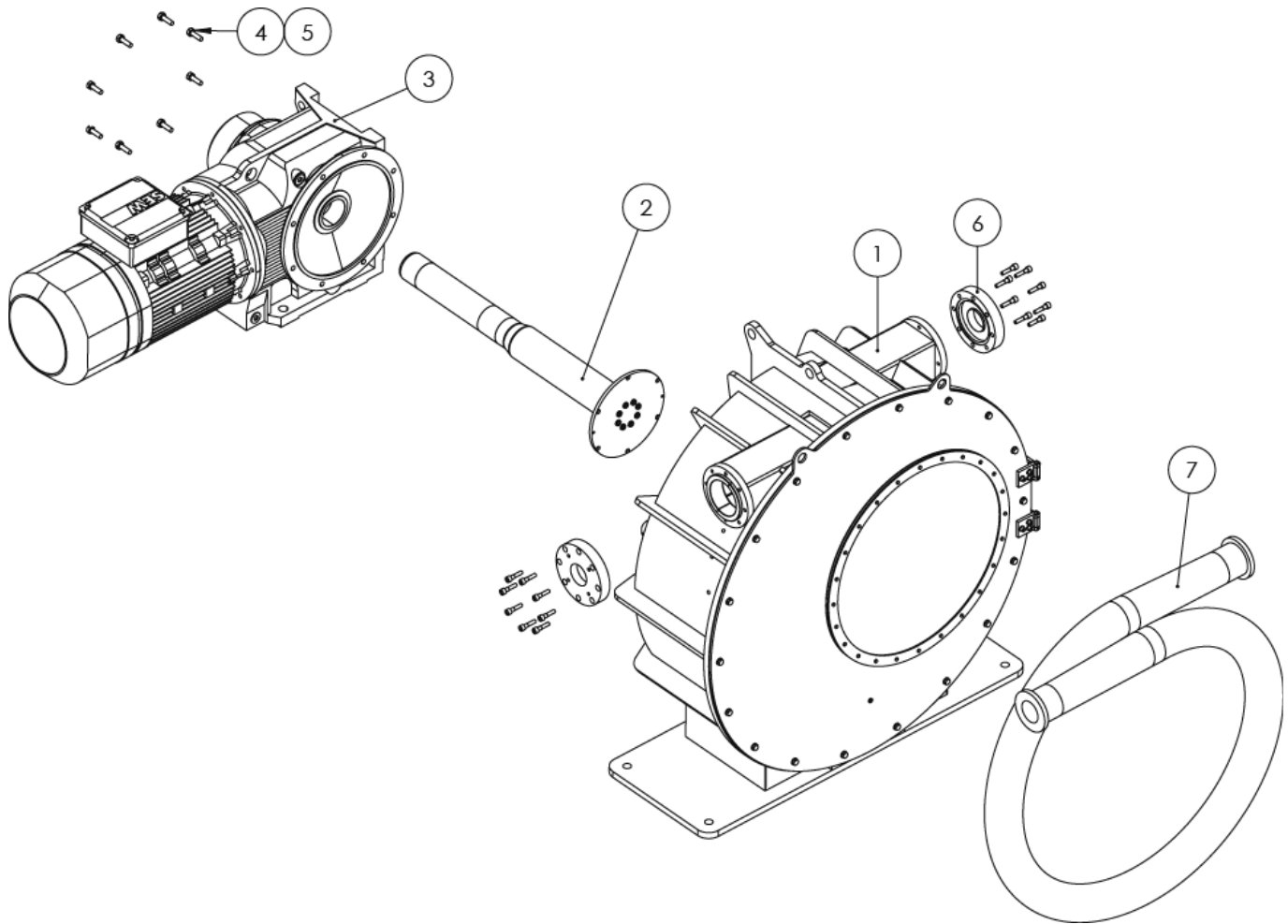

Figure 1. Exploded view of complete LPP-T100 pump

Item no.	Description	Qty
1	Pump head	1
2	Shaft assembly	1
3	Gear motor	1
4	Hex Screw	8
5	Washer	8
6	Connector flange	1
7	Hose	1

All exploded parts are modular and order specific. Adapter parts vary depending on the selected gear motor.

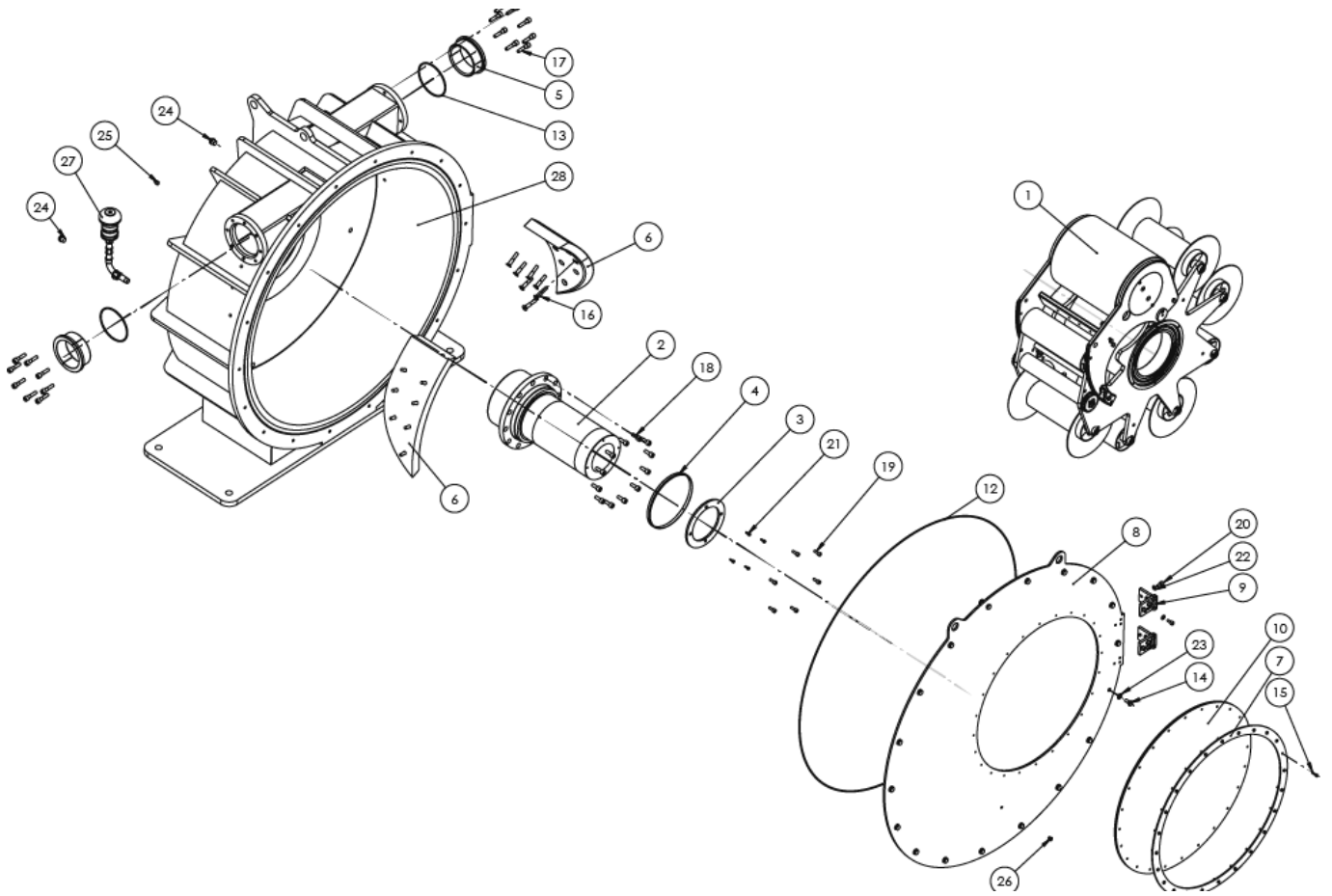

Figure 2. Exploded view of LPP-T100 pump head

Item no.	Description	Qty
1	Rotor assembly	1
2	Center hub	1
3	Flange for bearings	1
4	Wear ring	1
5	Bushing	2
6	Hose guide	2
7	Support for window	1
8	Front cover	1
9	Hinge	2
10	Front window	1
11	Window seal	1
12	O-ring	1
13	O-ring	2
14	Hex screw	18

Item no.	Description	Qty
15	Hex screw	24
16	Countersunk screw	14
17	Hex socket screw	16
18	Hex socket screw	12
19	Hex socket screw	6
20	Hex socket screw	12
21	Hex socket screw	4
22	Washer	12
23	Washer	18
24	Hex plug	3
25	Plug	1
26	Plug	1
27	Breather set	1
28	Body	1

2.3 Electrical equipment

Standard electrical equipment includes the following unless the pump is equipped with a vacuum assistant:

- hose leak detector

Optional electrical equipment includes the following:

- Control cabinet
- Pressure transmitter with display and overpressure limit
- Revolution detector
- Revolution counter and speed display (without wiring or box)

The control centre unit controls LPP-T pumps. The unit includes the following:

- Frequency inverter
- Required safety equipment
- Reversing switch in stopping position
- Fuses
- The possibility of connecting hose leak, overpressure, and revolution detectors

The electric motor can be operated with local speed control (potentiometer) connected to the control cabinet, or with a remote control (4–20 mA or 0–10 V) using a control signal.

The **control cabinet** can be installed in connection with the pump or as a separate unit. If the control cabinet is delivered as a separate unit, it must be connected by a person authorised to perform electrical connections.

The **pressure transmitter**, which operates with a voltage of 24 V, is equipped with a display and a programmable overpressure relay. It can be connected to the drive circuit of the control cabinet with a pilot wire. If the programmed pressure value is exceeded, the control cabinet stops the pump automatically. The transmitter can be programmed directly with the buttons on the transmitter. After stopping, the pump can be started again with the acknowledgement button.

	WARNING!
	Electrocution hazard. All electrification connections must be made by professionals only.

The **hose leak detector** is installed outside the pump housing, on the back wall. The detector is a two-wire, float-type switch

connected to the pump drive circuit. If the hose is punctured, the pumped medium starts to leak into the pump housing. When the surface of the liquid reaches the hose leak detector, the detector stops the pump. Connect the detector to a VFD or a control cabinet.

If the detector is connected to a control cabinet supplied by Valmet Flow Control Oy, press the acknowledgement button after a hose puncture. The pump can be started only after the button is pressed.

The **revolution detector** is an inductive sensor to be installed at the rear wall of the pump. It sends an impulse for each crankshaft rotation detected. The sensor requires an operating voltage of +24 V.

The revolution counter and/or speed display are installed on the door of the control cabinet. To operate, the counter and display require a power supply and the pulse data from the revolution detector. The counter has a battery backup in case of power failure.

2.4 Technical data

Pump parameters

Table 1. Pump parameters

Pump model	Maximum production (m ³ /h)	Production per revolution (litres)	Maximum pressure (bar)	Motor power (kW)
LPP-T100	100 (440.29 gpm)	31,6 (8.348 gal)	10 (145 psi)	37-75

	Large particles in the medium may harm or cause puncturing of the pump hose. The maximum particle size for the pump is 1/4 of the diameter of the hose in use, depending on the properties of the medium and the shape of the particles.
---	--

Dimensions and weights

The final dimensions and weight of the pump are determined partially by the pump drive unit and the optional equipment installed. The main pump dimensions are given in Appendix.

3 TRANSPORTATION, STORAGE AND LIFTING

The pump is delivered in a transport container. Use the original container for storing and transporting the pump until the final installation. Store the pump in a dry, cool place protected from sunlight. Before unpacking the pump from the transport box ensure that the pump foundation is finished and of the correct size and materials.

Pumps of certain sizes are delivered equipped with transport supports to ensure stability of the pumps. Do not remove the transport supports until the pump is secured to its foundation. For further instructions, see Chapter 4: 'Installation.'

If the pump unit is stored for a long time, do the following tasks:

Remove all medium from the pump hose.

Remove the hose from the pump, or release the hose compression to prevent fatigue of the hose during the storage.

Clean the pump housing.

Store the pump in a dry, cool place +5 - +20 °C (+41 °F - +68 °F) protected from sunlight.

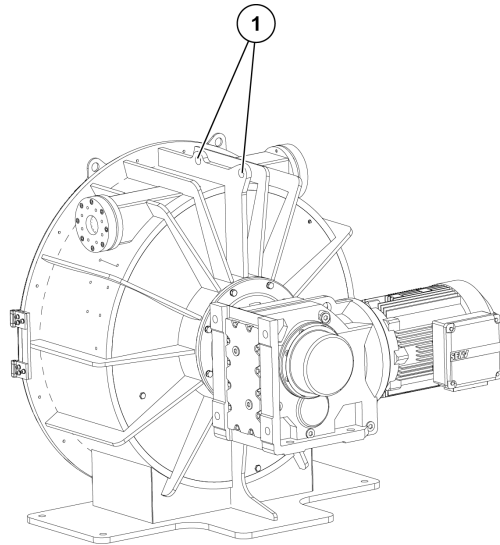
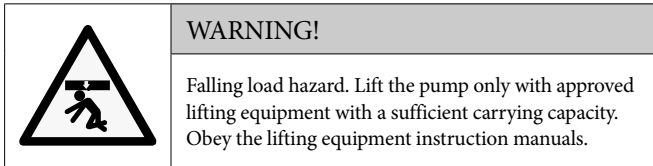
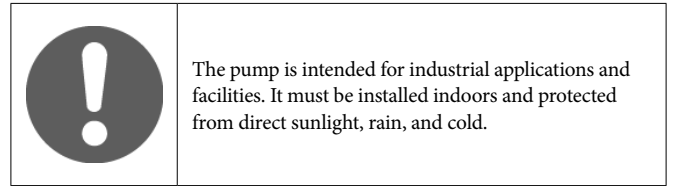

Figure 3. Lifting points

Lifting ropes **must not** be attached to the lifting eye of the gearbox or the motor.

4 INSTALLATION

4.1 General



Only professional personnel with appropriate training are allowed to install the pump. All installation and servicing tools and values are metric.

Tools needed for installation:

Fork wrench set

Allen wrench set

Torque wrench

Install the pump on the pedestal that is part of the pump body. If the pump has transport supports on delivery, do not remove the supports until the pump is secured on the installation foundation as instructed.

The pump is delivered fully assembled and ready for use, and it has a drive unit (with the exception of a so-called pump head deliveries that are ordered without the drive unit).

The following come as part of the installation for all pumps delivered to the customer by Valmet Flow Control Oy:

A suitable hose for the purpose

LPP-T lubricant

4.2 Pump installation

Keep the pump in its transport container until installation. See Chapter 3: 'Transportation, storage and lifting.'

Leave sufficient space around the pump for maintenance work. Note that the front cover is hinged and needs space for opening.

Table 2. Minimum free distances around the pump and flatness requirements for the pump foundation

Model	Front (m)	Right (m)	Left (m)	Behind (m)	Flatness requirement (mm)
LPP-T100	2,5 (8.20 ft)	1,5 (4.92 ft)	1,5 (4.92 ft)	1,5 (4.92 ft)	3 (9.84 ft)

Install the pump on a sufficiently strong foundation with fastening bolts or threads for fastening bolts. Build a sufficiently strong and level foundation for the pump of either concrete or steel. The foundation must be on a higher position than the floor level so that the pump does not get wet if a water damage happens. Fasten the pump with appropriate bolts from the mounting holes on the pump base plate. Other types of fastening are forbidden. Make sure that the carrying capacity of the foundation is sufficient, taking into consideration the weight of the pump and potential loads during use.

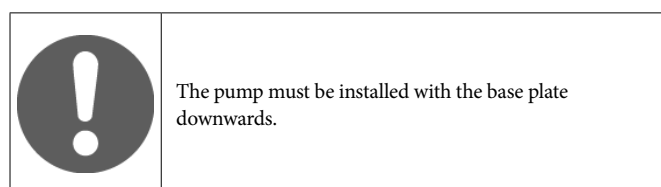
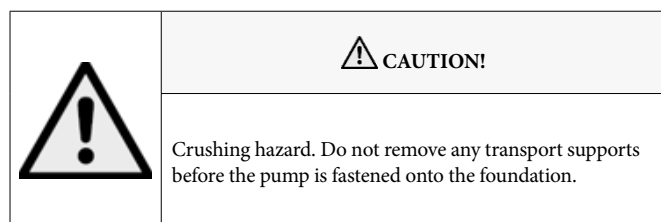

Table 3. Bolts for the pump foundation fastening

Model	Bolt	Tightening torque (Nm)
LPP-T100	M30	1200



When the foundation is ready for installation, install the pump:

- Lift the pump onto the pedestal as instructed in Chapter 3.
- Fasten the pump in place with foundation bolts, and tighten the bolts to the torque given in Table 3 (Bolts for the pump foundation).
- Remove the transport supports, if any.
- Cast the possible after cast concrete. (Not for the steel foundation)

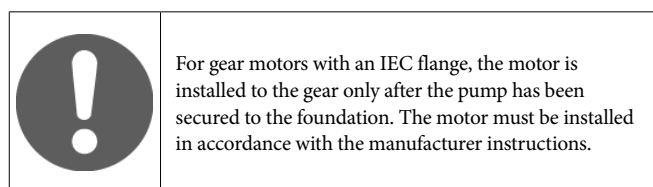
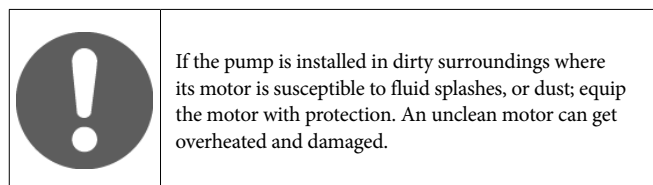

4.3 Electrical connection

Do the motor connections in accordance with the manufacturer instructions. Equip the motor power supplies in accordance with safety regulations, at least with maintenance and emergency stop switches, motor overload protection, and fuses.

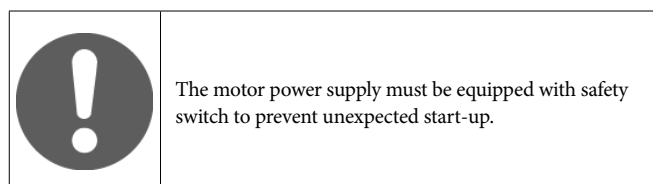
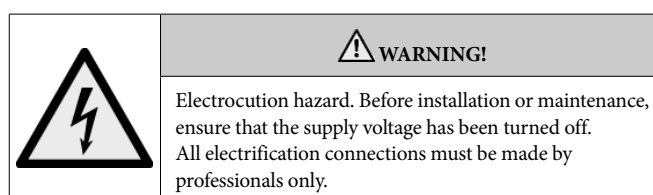

4.4 Piping connections

General

The rotation direction set as standard for the pump is clockwise when the pump is viewed from the front (with the transparent maintenance window).

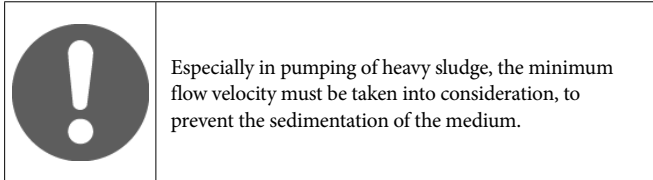

Connected piping should meet the following requirements:

- To minimise pressure loss, the nominal size of the piping should be at least one size larger than the nominal size of the pump.
- **Connect the pump to the piping with flexible, pressure-proof hoses to facilitate maintenance work and to dampen the pressure shocks (pulsation) generated by the pump.** The amount of pulsation (pressure change) depends on the following factors: the counter pressure of the piping, the capacity of the piping, the flow velocity, equipment installed in the piping, and the rotation speed of the pump.
- Consider the strength of the pipeline supports, as the vibration in the piping may cause strain in the pump housing.
- If the pressure shocks of the pump disturb the pumping process, the pulsation can be dampened with special pulsation dampers installed in the pipeline.
- If there are closing valves on the discharge side of the pump, a pressure relief valve that prevents overpressure must be installed between the valve and the pump.

The discharge and suction connections of the pump consist of standard-compliant flange connection surfaces. Their boring is customer-specific. The lengths of the bolts required for the flange connection are given in Table below.

Table 4. Fastening bolt lengths

Model	Length of fastening bolt (mm)
LPP-T100	30 mm (1.18 in) + thickness of customer flange and gasket

5 PUMP OPERATION

The pump is normally delivered with pre-installed hose and lubricant. The drive unit (gearbox and motor) is installed prior to the delivery of the pump. In this case, the pump is ready to be used with the nominal parameters indicated on the pump's type plate. If the pump is delivered without the motor (pump head delivery), the motor must be installed in accordance with the manufacturer instructions.

If pump is delivered without frequency inverter, use a soft starter to avoid damage.

5.1 Commissioning

Before starting the pump, ensure that it has been installed in accordance with the instructions in this manual and applicable safety regulations.

At least the following must be ensured:

- The pump is used only for the purpose specified at the time of sale.
- The hose installed is compatible with the pumped medium.
- The parameters on the type plate are suitable for the process values required of the pump. The piping the pump is connected to has sufficient ability to withstand pressure.
- The required pressure relief valves have been connected and work correctly.
- Electrical work is done by an authorised electrician.
- Starting the pump does not put personnel or equipment in danger.
- The pump is correctly connected to the piping and all connections are pressure-proof.
- The valves of all suction and pressure lines connected to the pump are open.
- The pump settings are correct.
- The amount of hose lubricant is sufficient.
- If the pump is equipped with a frequency inverter, the minimum frequency set is sufficient to ensure the cooling of the pump in all conditions. If the required minimum frequency is below 20 Hz, the pump must always be equipped with an additional cooling fan.

5.2 Operation

The continuous maximum operating speeds of the pumps are given in Table 5. If faster operating speeds are required, contact your nearest LPP-T pump representative.

Table 5. Maximum operating speeds

Model	LPP-T100
Speed (rpm)	53

After starting, the pump starts rotating at its nominal speed (unless it is equipped with a frequency inverter). The nominal speed produces a nominal volume flow.

If the pump has a frequency inverter, the rotation speed of the pump depends on the value set for the frequency inverter. If the pump has a frequency inverter using slow rotation speeds, ensure that the pump motor does not overheat.

	Especially in pumping of heavy sludge, the minimum flow velocity must be taken into consideration, to prevent the sedimentation of the medium.
--	--

	Never close the pump valves on the delivery side of the pump, as this may cause overpressure and damage the pipeline or the pump.
--	---

If the solid matter content of the pumped medium is high, the pipe lines must be flushed when the pump is stopped. This prevents the formation of blockages in the piping caused by sedimentation of the medium.

	A hose leak detector can be delivered with the pump. The product must be connected to the control system in order to guarantee correct operation. Using the pump without the hose leak detector voids the warranty.
--	---

The need to replace the hose can be monitored during use of the pump by checking the volume flow of the pump and the pump velocity. If the volume flow per rotation is lower than the nominal production per rotation, the hose must be replaced.

6 SERVICING AND MAINTENANCE

6.1 General maintenance and checks

The process functions of peristaltic hose pumps are often critical. In order to guarantee problem-free and reliable operation, the pump must be monitored, and a basic check must be performed daily.

The hose used for transferring the pumped medium is the only part of the pump that needs regular replacement. Checking the condition of the hose is therefore the most important maintenance procedure for the pump. The most fundamental factor influencing the duration of the service life and the maintenance interval of the hose is correct adjustment of the hose compression.

Observation during use

1. Check the condition of the pump hose regularly; visually estimate the condition of the hose and monitor the flow meter parameters:
 - Volume flow produced by the pump.
 - The rotation speed of the pump.
 - The volume flow (l/min) produced by the pump is divided by the rotation speed (rpm) of the pump. Compare the resulting volume flow per revolution figure with the equivalent figure of a new hose, or with the figure given in the technical specifications.
 - The volume flow produced by the pump depends on the properties of the pumped medium (viscosity, density, etc.), the suction height, and so on.
 - Reduced production per rotation indicates that there is backflow via the compression point.
2. Check the condition of the gear unit and the bearing gaskets visually for oil or grease leaks. If any leaks are detected, replace the gaskets (and bearings, if necessary).
3. An abnormal pump operating sound may indicate a damaged bearing or coupling.

	Keep the motor surface clean from oil and dirt. If the cooling ribs of the motor are covered with dirt, the motor may overheat and become damaged.
---	--

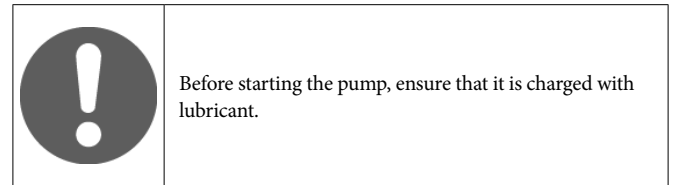
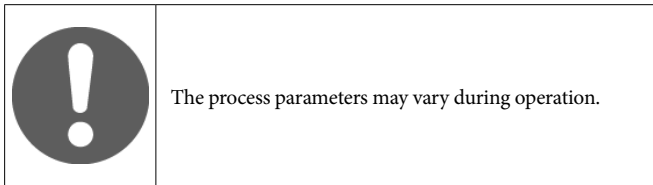

Required maintenance tools

- Torque wrench for adjusting screws
- Allen wrench set
- Fork wrench set, 10–24 mm
- Allen key: 12 mm
- Combination spanner/socket wrench: 17, 24 mm
- Square key: ½ “

Spare parts

To ensure correct and quick delivery of spare parts, the order must contain at least the following information found on the type plate of the pump:

- Pump serial number
- Pump type
- Nominal production and pressure of the pump
- Manufacturing year of the pump

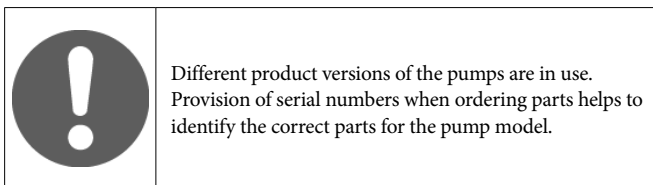

The pump parts, with corresponding number or code, can be found in the drawings at the end of this manual.

Lubrication

Lubricating the hose

Lubricants are used to reduce the friction between the hose and the rotor. The lubricants are classed into two different quality categories: food-grade quality and non-food-grade quality. The operating temperature range for original LPP hose lubricants is –20 °C to 100 °C (–4 °F to 212 °F).

Check the correct amount of lubricant for your pump from Appendix: ‘Required amounts of lubricant for LPP hoses.

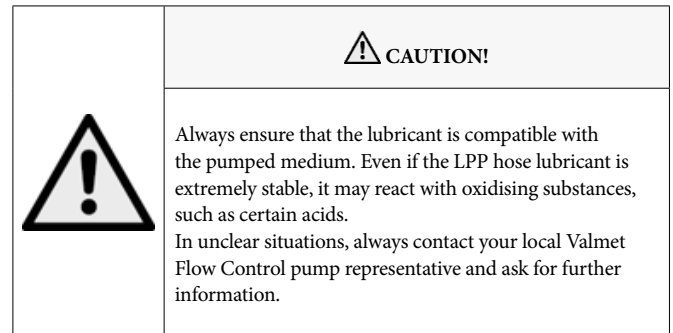

Lubricating the bearings

(See, in Appendix, the section ‘Required grease additions’)

The pump unit bearings (rotor and body bearings) are greased for the duration of three months of normal operating conditions. Add 5% grease to the body bearings after every three months of operation (see Appendix, section “Required amounts of lubricant”). The suitable grease type for the bearings is SKF LGHP2 or equivalent.

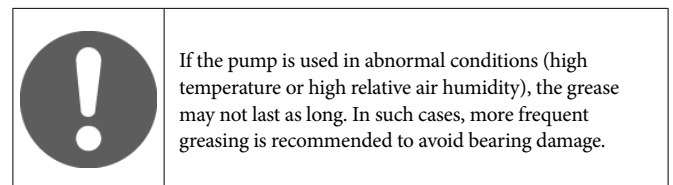

Lubricating the gearbox

Lubricate the gearbox in accordance with the manufacturer’s instructions (delivered with the unit).

6.2 Changing the hose

Before starting maintenance work, see section 6.2.1 preparations.

The hose change crank cam is included with the pump delivery, which makes it possible to do the hose changing without electricity (excluding the special pump models). If there is no crank cam included in your pump delivery, please contact the authorized representative of Valmet Flow Control. The crank is included in the pump delivery only if the pump is delivered as a complete, meaning with gear and motor.

Required tools:

- Allen key: 12 mm
- Combination spanner/socket wrench: 17, 24 mm
- Square key: ½ “

Removing the hose

Recommendation is to have 2 persons to operate.

1. Obtain a clearance certificate for maintenance and perform a lockout procedure. The pump must be stopped with the rotor in the bottom most position and turn the power off with the maintenance switch. The rotating of the rotor is meant to be done with the crank cam without electricity.
2. Discharge the lubricant from the pump via possible drainage valve or, alternatively, by opening the front cover. Protect yourself from splashes.
3. Release the pipeline from the pump.



Figure 4. Removing the hose

4. Remove the motor shaft cover set screw.



Figure 5. Removing the motor shaft cover set screw

5. Remove the shaft cover.



Figure 6. Removing the motor shaft cover

6. Put the hose crank cam on the shaft.

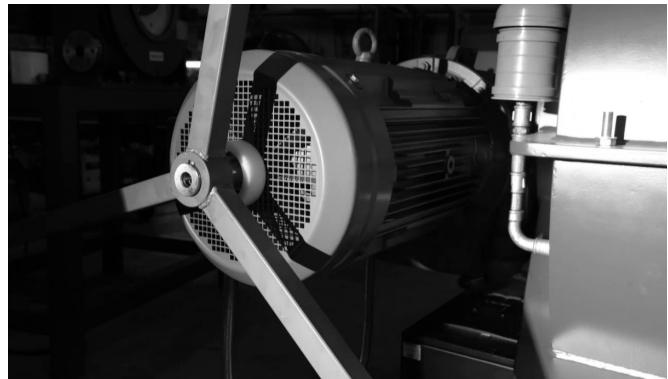

Figure 7. Installing the crank cam

7. Open the front cover.



Figure 8. Opening the front cover

8. Rotate the rotor to the lower position.



Figure 9. Rotating the rotor

9. Remove the compression key locking bolt and cradle locking bolts.

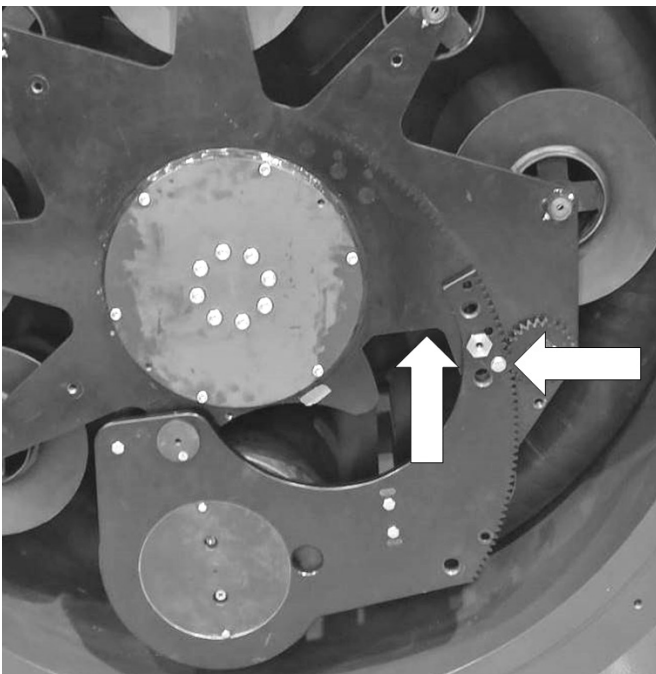

Figure 10. Removing the compression key locking bolt and cradle locking bolts.

10. Remove the compression key.



Figure 11. Removing the compression key

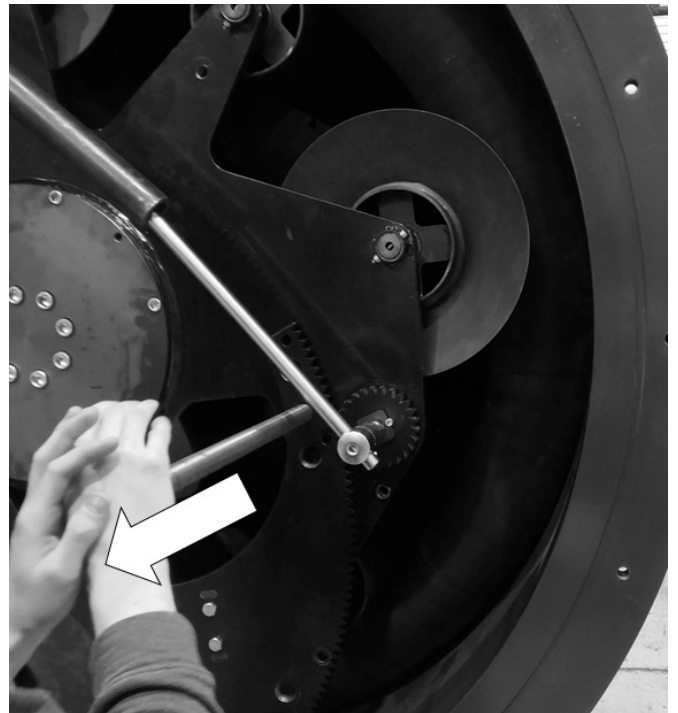

Figure 12. Removing the compression key 2

11. Loosen the hose compression with T-tool.

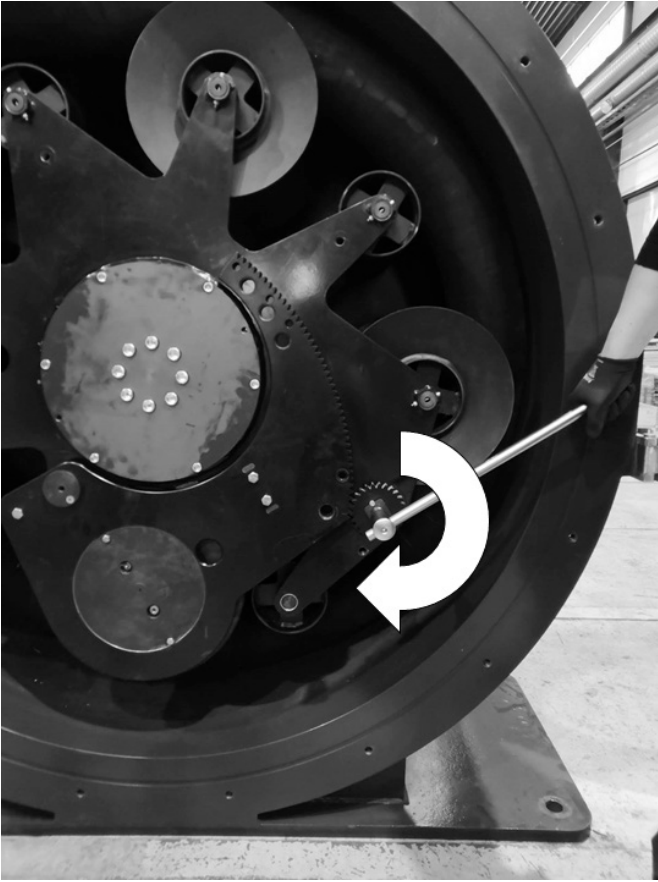

Figure 13. Loosening the hose compression

12. Reinstall the compression key and locking bolt.

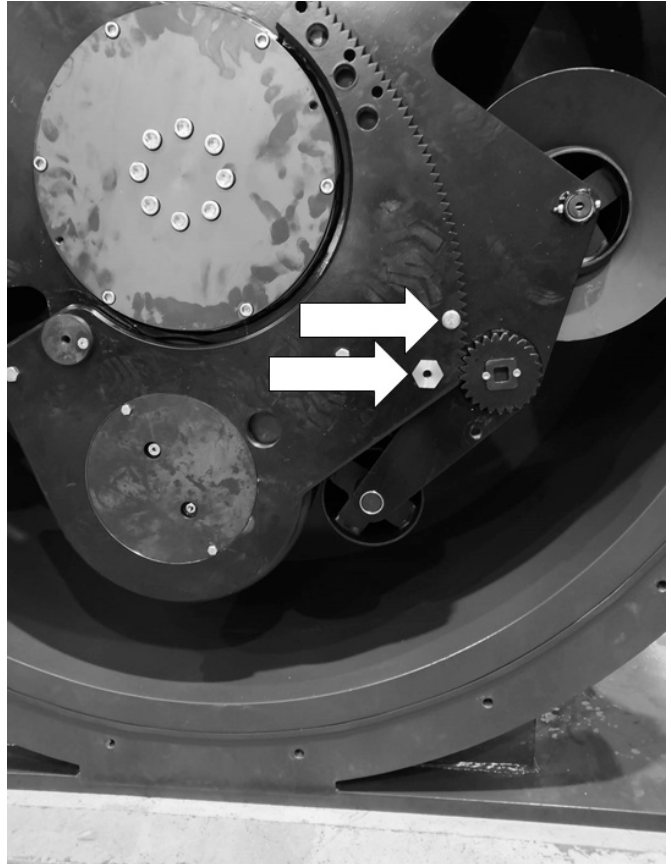

Figure 14. Installing the compression key and locking bolt

13. Remove connection flanges and O-rings from both ends of the hose.



Figure 15. Removing the connection flanges and O-rings

14. Tie the hose to the guide roller with a strap.



Figure 16. Securing the guide roller 1

15. Secure the strap with a suitable method.



Figure 17. Securing the guide roller 2

16. Remove the hose by pulling it and rotating the pump with the hose crank cam.



Figure 18. Removing the hose

17. Clean the hose leak detector and breather with water.



Figure 19. Cleaning the hose leak detector

18. Clean the pump with water and solvent.

19. Make sure that all of the guide rollers rotate easily and add grease to the shafts if needed.



Figure 20. Cleaning the pump

20. Open the air plug.



Figure 21. Opening the air plug

21. Add grease to the rotor bearings until it comes out of the air plug hole. Rotor must be filled with new grease.

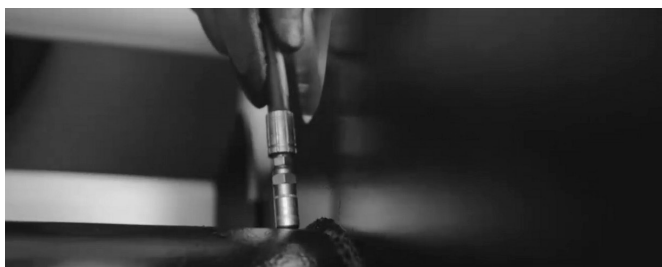
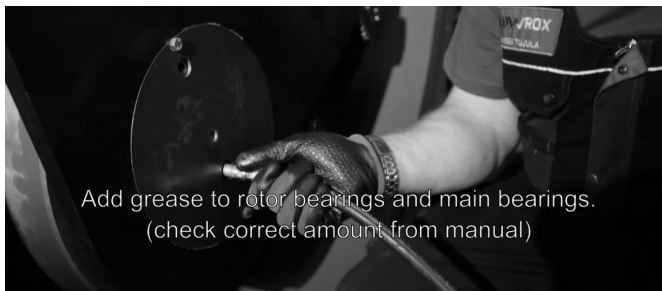

Figure 22. Adding grease to the rotor bearings

22. Lift the first hose end into the inlet.



Figure 23. Installing the hose 1

23. Lubricate the outside of the hose lightly.



Figure 24. Installing the hose 2

24. Push the hose into the pump.





Figure 25. Installing the hose 3

25. Tie the hose to guide-roller with a strap.



Figure 26. Installing the hose 4

26. Rotate the pump with the crank cam. Do not release the crank cam when the rotor is up.

	 CAUTION!
	Crushing hazard.
	Unexpected rotor movement can cause crushing injuries. Make sure that the rotor does not move by locking it in place or by controlling the crank cam..

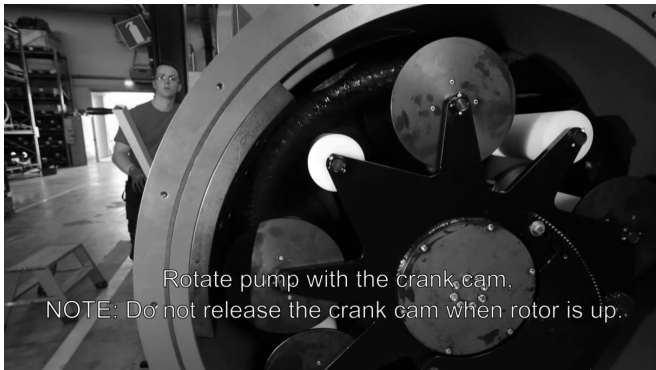

Figure 27. Installing the hose 5

27. Guide the hose end to the outlet.



Figure 28. Installing the hose 6

28. Add the split bushing and the o-ring.



Figure 29. Installing the hose 7

29. Rotate the pump the opposite way and pull the hose end into the correct place.

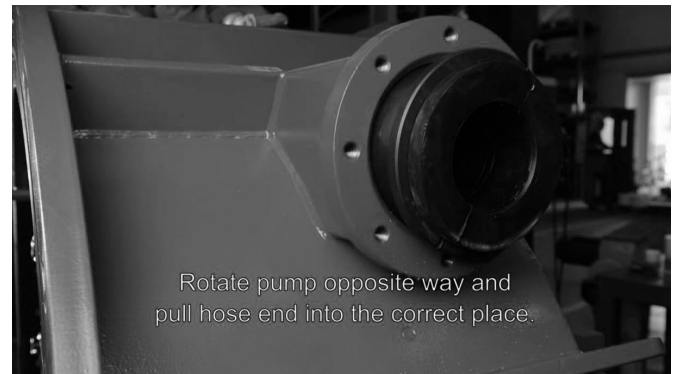

Figure 30. Installing the hose 8

30. Install the connection flange with bolts but leave them loose.



Figure 31. Installing the hose 9

31. Change the strap position.

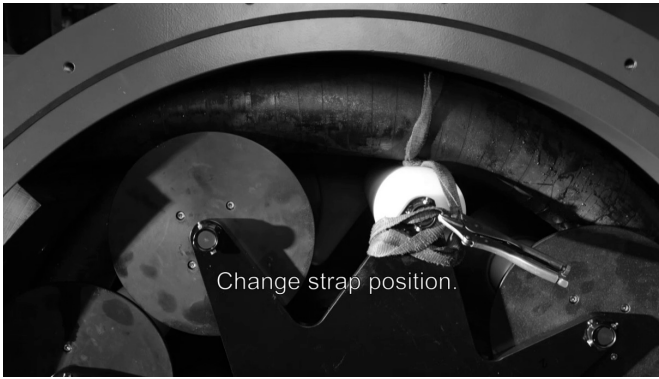

Figure 32. Installing the hose 10

32. Add the split bushing and the o-ring to the other side of the hose.



Figure 35. Installing the hose 13

36. Remove the locking bolt and compression key.
37. Rotate the hose compression with T-tool.



Figure 33. Installing the hose 11

33. Install the connection flange. Fasten with bolts in a cross format.



Figure 34. Installing the hose 12

34. Fasten the opposite side connection flange bolts in a cross format.
35. Rotate rotor to the lowest position.
Note: do not release the crank cam while rotating.

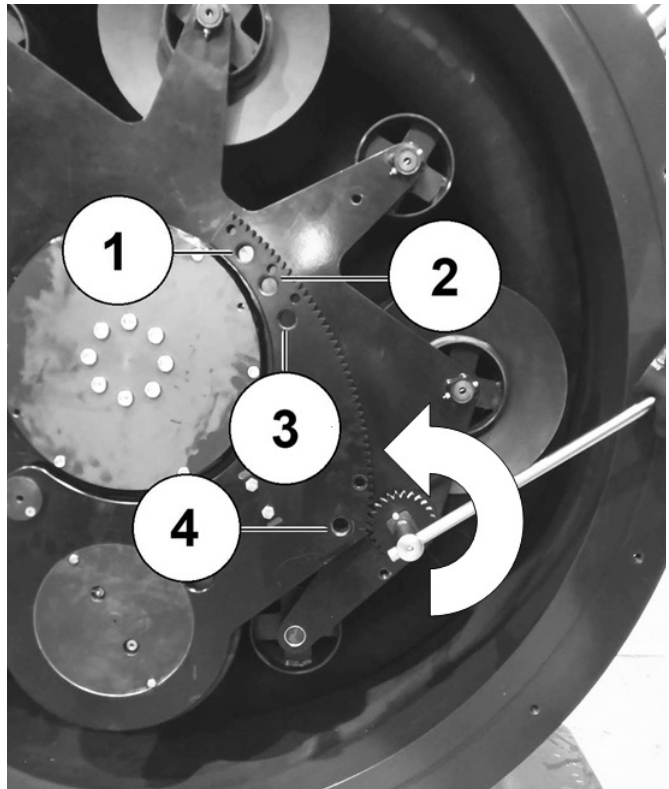

Figure 36. Installing the hose 14

38. Install the compression key in correct position.
NOTE:

- (1) position is for high pressure range 8-10 bar (116 - 145 psi)
- (2) position is for mid pressure range 5-7 bar (73 - 102 psi)
- (3) position is low pressure range 2-4 bar (29 - 58 psi)
- (4) position is for maintenance



Figure 37. Installing the hose 15

39. Tighten the compression key.



Figure 38. Installing the hose 16

40. Install the compression key locking bolt and cradle locking bolts.

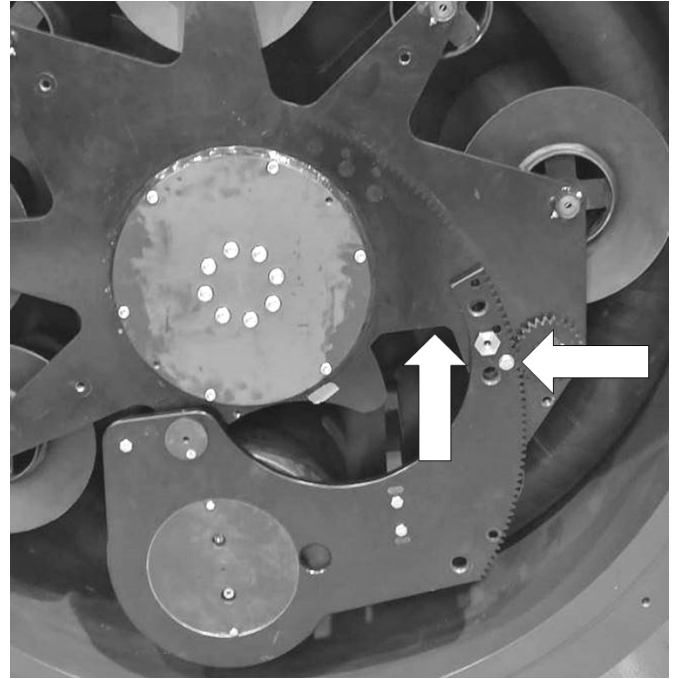

Figure 39. Installing the hose 17

41. Close the front cover. Add and tighten the bolts.



Figure 40. Closing the front cover

42. Open the maintenance window of the front cover.



Figure 41. Opening the maintenance window

43. Add glycerine to the pump through the maintenance window. See appendix for the correct amount.



Figure 42. Adding glycerine to the pump

44. Close the maintenance window front cover. Add and tighten the bolts.



Figure 43. Closing the maintenance window

45. Remove the crank cam and install the shaft cover and the screw set.



Figure 44. Installing the shaft cover

46. Connect the pump to the pipeline.

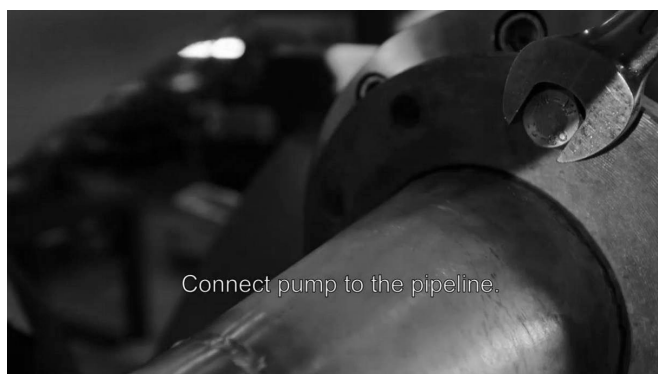

Figure 45. Connecting the pump to pipeline

6.3 Maintenance

Installing the gearbox

Remove the gearbox as follows:

1. Turn the power off and remove the cables (this must be done by a qualified electrician).
2. Support the gear unit with a hoist.
3. Release the shrink disc connection.
4. Remove the fastening bolts for the adapter flange.
5. Lift the gear unit off the pump on top of a worktable.

6.4 Troubleshooting

Table 6. Troubleshooting

PROBLEM	POSSIBLE REASON	ACTION
The pump won't start.	The power is not on. The supply cable is not connected or is connected incorrectly. There is a power supply problem. Safety locking is on.	Turn the power on. Connect the supply cable (authorised electrician only). Check the power supply (authorised electrician only). Acknowledge the safety equipment.
The pump does not produce volume flow.	The suction valve is closed. The suction line is blocked.	Open the suction valve. Check the suction piping.
The pump does not produce full volume flow.	The viscosity or specific weight of the pumped medium is too high. The suction line is partly blocked. The suction height is too high.	Check the measurement parameters of the pump and the properties of the medium. Clean the suction piping. Check the suction piping.
The hose life is short.	Too little LPP-T lubricant has been used. There are loose particles in the medium that damage the hose.	Check the amount of lubricant. Prevent large particles from entering the pump.
Pump output drops in mid-operation.	The suction piping is partly blocked.	Readjust the hose compression. Clean the suction piping.
The pump won't restart.	The pressure in the piping is too high. There is a blockage in the piping. There is a blockage in the pump hose.	Identify the cause of excessive pressure in the piping. Clean the piping. Clean or change the hose. Acknowledge the safety equipment.
There is medium in the pump housing.	The hose is leaking.	Clean the pump housing and change the hose.
The pump starts but stops shortly afterwards.	The supply cables have been connected incorrectly (star/delta connection).	Check the power supply (authorised electrician only).

APPENDIX A: Tightening torques for LPP-T pumps

Table 7. Tightening torques

Part code	Type	Tightening Torque Nm
	DIN 933 M20 x 60	280
2304	DIN 933 M16 x 30	140
5494	DIN 912 M12 x 30	57
2295	DIN 933 M8 x 25	17
	DIN 912 M16 x 70	140
	DIN 912 M16 x 45	140
71124	DIN 912 M12 x 25	57
60213	DIN 912 M8 x 20	17
	DIN 7990 M6 x 30	7

See the locations of parts via the enclosed assembly drawings.

APPENDIX B: Required amounts of lubricant for LPP-T hoses

Table 8. Required amounts of LPP lubricant

Pump size	LPP-T100
Amount of lubricant, litres	25 (6.60 gal)

	The figures given in the table are minimum lubricant amounts. Larger amounts can be used, but in such cases the lubricant may leak through the breather piping of the housing, or the hose leak detector may not work correctly.
--	--

Table 9. LPP hose lubricants

LPP hose lubricant	Code	Note
5 litres (1.32 gal)	80066, foodgrade quality	Not to be used with oxidising substances
10 litres (2.64 gal)	80067, foodgrade quality	Not to be used with oxidising substances
5 litres (1.32 gal)	80232, foodgrade quality	Silicon (ATEX)
10 litres (2.64 gal)	80233, foodgrade quality	Silicon (ATEX)

APPENDIX C: Hose leak detector chart

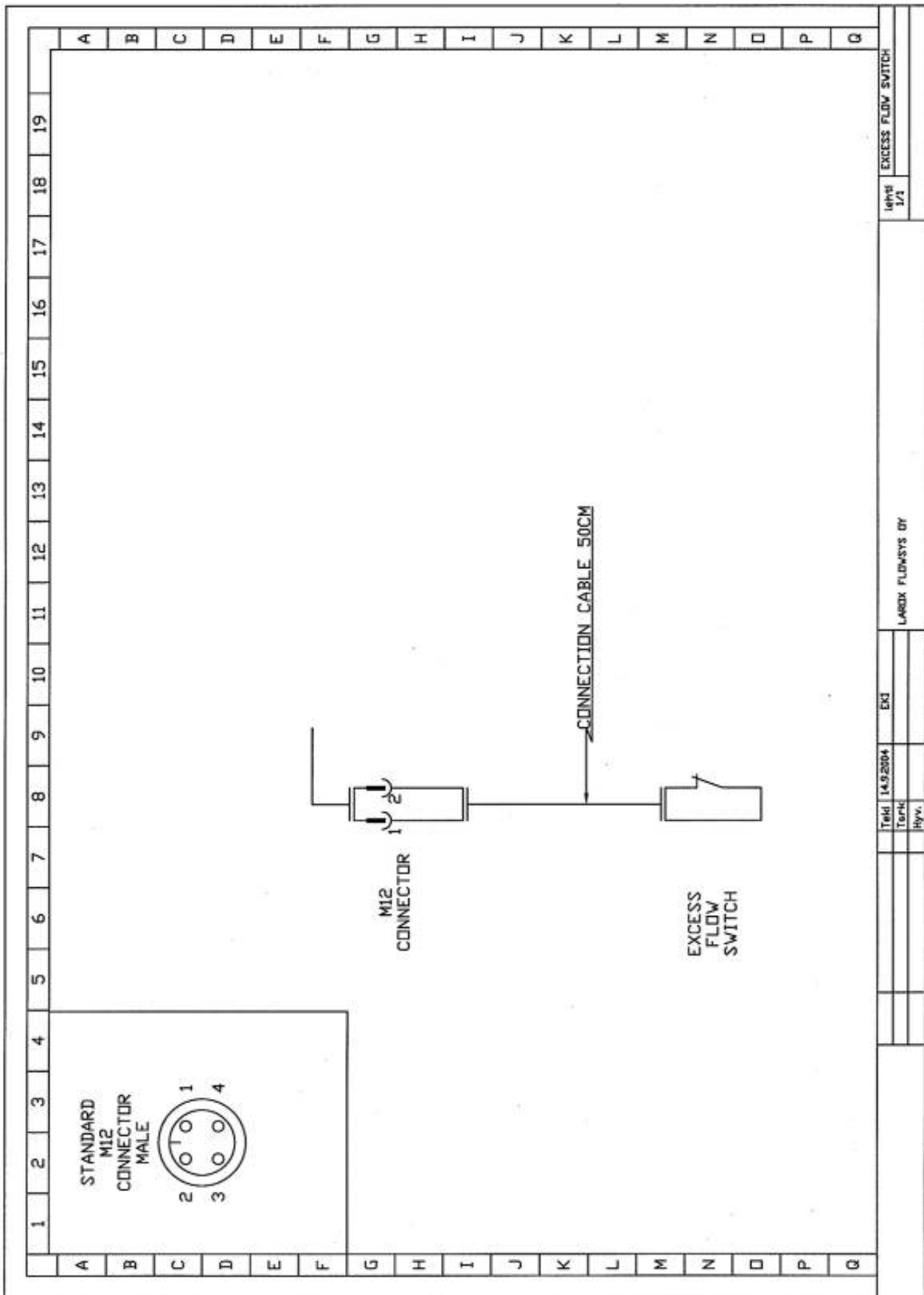

APPENDIX D: Claim form

The purchaser must file a claim for all compensation related to the hose and pump guarantee within 30 days after the fault has been detected.

The following information must be included. Fill in the form using block letters, or provide the manufacturer with the same information in another manner. In any instance, the claim must be made in writing.

PUMP SERIAL NUMBER:	
DATE WHEN THE FAULT WAS DETECTED (dd.mm.yyyy):	
OPERATING CONDITIONS IN WHICH THE FAULT WAS DETECTED:	
DESCRIPTION OF THE FLOWING MEDIUM:	
AN EXACT DESCRIPTION OF THE FAULT:	

If all of the above information is not sent to the manufacturer in writing, the purchaser loses the right of guarantee.

APPENDIX E: Dimensions, LPP-T100 pumps

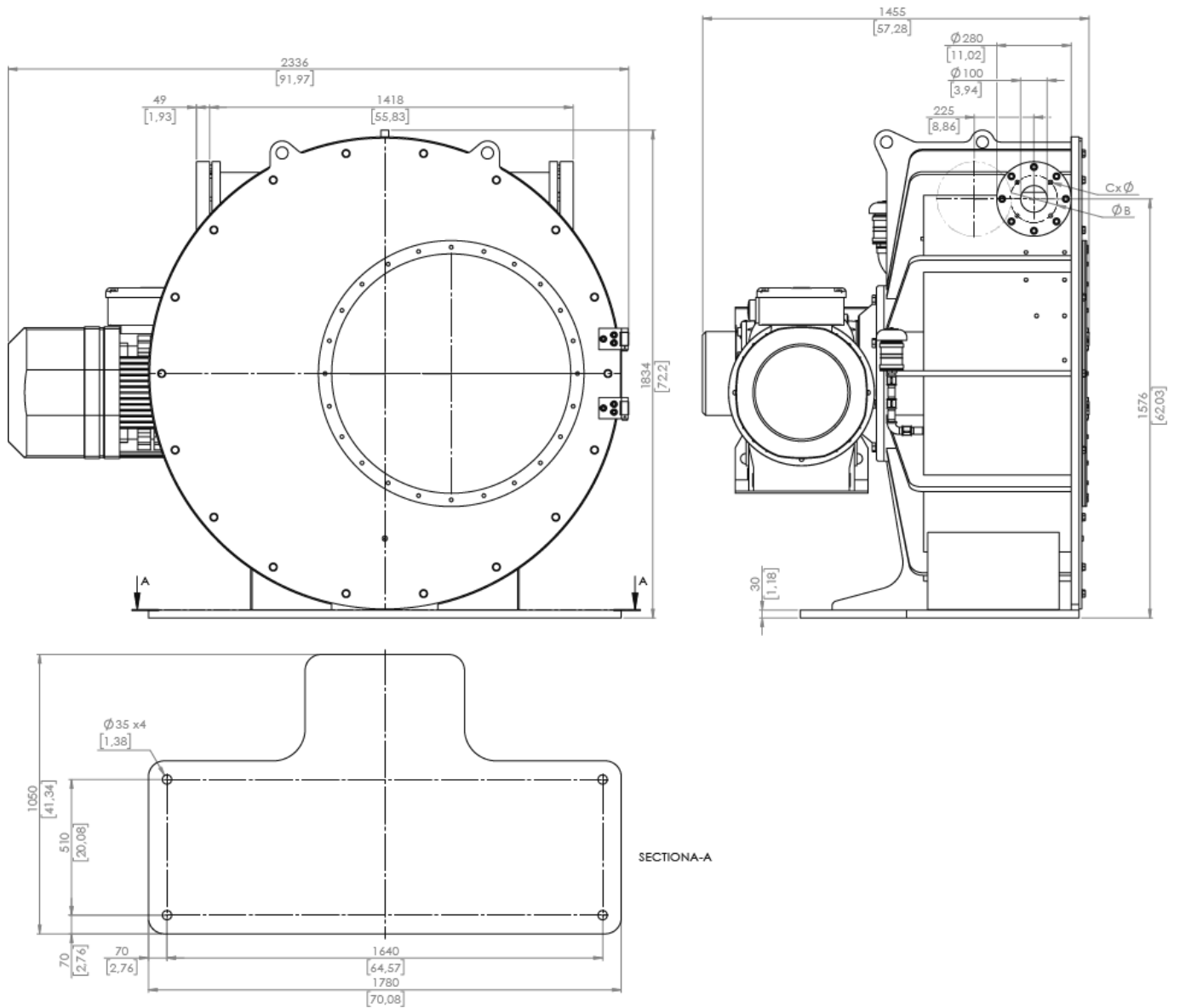

Dimensions with the largest available motor size (SEW KHF157, 75kW). Connector flange drillings options: DIN PN10, ANSI 150, BS TABLE D, AS TABLE E/D. $\varnothing B$ and $C \times \varnothing D$ according to drilling standard. Other drillings by request.

Valmet Flow Control Oy

Marssitie 1, 53600 Lappeenranta, Finland.

Tel. +358 10 417 5000

www.valmet.com/flowcontrol

Subject to change without prior notice. Neles, Neles Easyflow, Jamesbury, Stonel, Valvcon and Flowrox, and certain other trademarks, are either registered trademarks or trademarks of Valmet Oyj or its subsidiaries in the United States and/or in other countries. For more information www.neles.com/trademarks

