

**QUARTZ® QX/QN/QG SERIES**  
**VALVE COMMUNICATION AND CONTROL**  
EXPLOSIONPROOF, NONINCENDIVE, I.S. & GENERAL PURPOSE  
ON/OFF VALVE CONTROLLER

QUARTZ  
QX/QN/QG





# Quartz®

## Explosionproof valve monitoring

The Quartz is available in explosionproof (QX), nonincendive, intrinsically safe (QN), and general purpose (QG) versions. The robust epoxy-coated anodized aluminum construction, and optional stainless steel version, makes this platform extremely durable and well-suited for use in corrosive, heavy washdown environments.

Options may be selected to accommodate most applications.

### Save space with low profile design

Clearance above the actuator is critical in complex piping systems. Quartz boldly displays valve position and encloses all electrical components in an explosionproof compartment with less than 5" clearance requirement.

### The Quartz series

The Stonel Quartz series is durable, corrosion-resistant, and versatile, making it ideal for most of your process valve monitoring requirements.

#### Enclosures optimized for environment



**QX:** Explosionproof, water tight and corrosion-resistant enclosure is approved for use in Div. 1/Zone 1 hazardous areas. Available options include stainless steel and epoxy-coated anodized aluminum.



**QN:** Nonincendive is approved for Div. 2/Zone 2 hazardous environments with proximity sensors using a clear cover. Intrinsically safe NAMUR sensors or passive switches are available for Div. 1/Zone 0 applications.



**QG:** General purpose features a clear Lexan® cover with mechanical switches. All enclosures are rated NEMA 4, 4x, and 6.

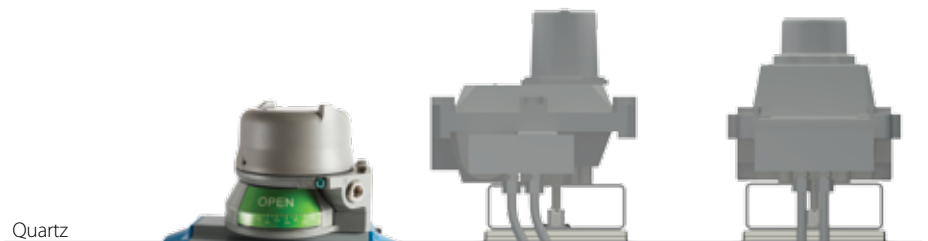

## Features

### 1. Enclosures optimized for environment

Available in three enclosure styles suitable for use in various process environment areas.

### 2. Rapid enclosure access

Screw-on cover allows quick enclosure access, saving you valuable maintenance and set-up time. The cover provides a vaportight seal and allows entry to internal components in less than five seconds.

### 3. Faster wiring

Pre-wired and labeled terminal strip enables quick, convenient attachment of field wires.

### 4. Wide variety of switching & communication

Switching options include dual module sensors and communication, Maxx-Guard proximity switches, and mechanical switches. Continuous signal output is available in a 4-20 mA position transmitter.

### 5. Quick set cams are easy to adjust

Touch and tune switch settings allow you to make adjustments in seconds without the use of tools.

### 6. Dual shaft o-ring seals eliminate corrosion

Top inner and bottom outer shaft o-rings seal the drive bushing from both external corrosives and internal contaminants that enter the enclosure.

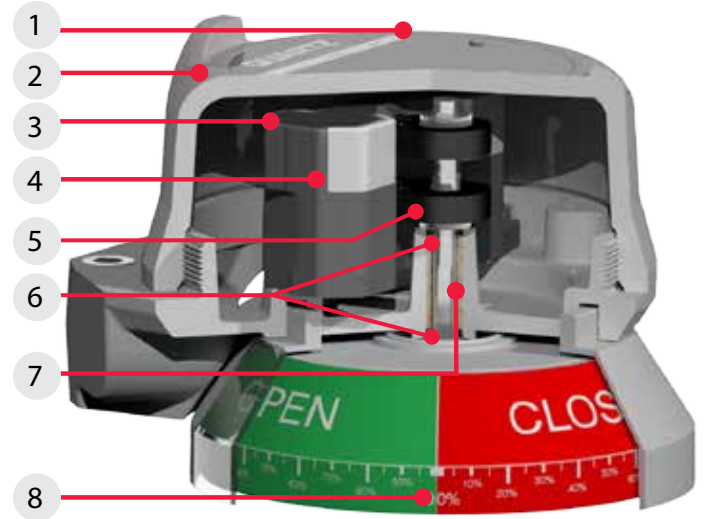

### 7. Special drive bushing assures long cycle life

The oil impregnated bronze bushing maintains smooth operation and eliminates the potential for shaft seizure due to actuator shaft eccentricity.

### 8. Bold space saving visual indication

Visual indicator offers excellent viewability without sacrificing accessibility or adding to space requirements. Indicators are also available with continuous percentage or three-way indication. (See page 15)

## Wide variety of switch/sensor functions

A wide variety of switch/sensor communications and position transmitters may be selected for the Quartz series. Options include 2, 4 or 6 mechanical or proximity switches, position transmitters with or without switches, and the StoneL dual module with two SST or two NAMUR sensors or AS-Interface, DeviceNet™ or Foundation Fieldbus communication capabilities.



Proximity switches



Mechanical switches

## Speed installation with LED indication

StoneL's coordinated visual indicator and LEDs give you an extra measure of safety and increased convenience during plant start-up and operation. Green visual indication and green LED means the valve is open and the computer circuit is properly operating. Red visual indication and red LED means the valve is closed and the computer is properly functioning properly.



## Eliminate seal fittings in Division 1 and 2 areas

FMus ratings certify the Quartz QX series with proximity switches for use without seal fittings in all hazardous areas. By passing special pressure piling tests, the all aluminum enclosure was certified for this elite distinction. Now, a time-consuming procedure can be safely eliminated in Division 1 and Division 2 areas.

## Consolidate your components and minimize costs

The Quartz design offers up to three conduit entries with extra wire terminations. By terminating solenoid valves in the switch enclosure, significant savings are realized by eliminating a junction box, wiring, conduit materials, and labor.



# Mounting kits Kits may be ordered in 316 stainless steel. Consult StoneL factory for details.

## Sealed mounting kit

Mounting to standard actuators is achieved with a bold visual indicator and sealed mounting system. Sealed mounting is exclusive with extended visual indicator option N. Adaptor plate is epoxy-coated anodized aluminum. All fasteners and couplings are stainless steel.



- Direct mount to actuators with VDI/VDE 3845 interface.
- Tolerant to vibration and mechanical stress.
- Prevents contamination and icing in coupling area.
- Available for all VDI/VDE 3845 (NAMUR) mounting configurations and most quarter-turn actuators.



## Quarter-turn actuators

Low profile convenient mounting systems are readily available in stainless steel for most standard actuators.



## Positioners

Quartz position transmitter and switches may be retrofitted directly to most positioners. 4-20 feedback may be provided on simple pneumatic positioners.



## Manual valves

Proper fit and operation is assured with StoneL's custom designs for each manual valve. Hundreds of unique mounting systems have been designed and fabricated for manually operated valves.



## Linear operators

Precision ball joint connections attach the Quartz to valve travel stems. Stroke lengths ranging from 20 mm to 150 mm (¾" to 6") may be easily accommodated.



## Quartz stainless steel option



### For the most challenging environments

The explosionproof Quartz for process valve monitoring is available with a 316 stainless steel enclosure that is extremely durable and well-suited for use in corrosive, heavy washdown and high seas environments. A broad range of switching, position transmitters and communication options may be selected to accommodate most applications. You can attach the Quartz to quarter-turn actuators, manual operators, linear operators, and positioners using readily available stainless steel mounting systems.



## Position transmitter

### 4-20 mA position transmitter

Position transmitters provide a precise 4-20 mA signal on a two-wire DC loop. Control valves and dampers are accurately monitored through their range of travel offering assurance of exact valve position at all times. Several function options are available making it easy to find the correct product that fits your desired application. Choose a position transmitter with a standard potentiometer (5\_), a vibration proof, high-performance potentiometer (7\_), or the innovative non-contact magnetic resistive (mag res) digital transmitter (T\_).

### Digital transmitter

The digital transmitter utilizes an innovative non-contact magnetic sensor. The module features easy push button calibration to reduce set-up and commissioning time. With the bold red/green LED indication, the unit is visible from a distance and the calibration diagnostic LED indications confirm set up is valid. The position transmitter module housed with the Quartz platform is fully sealed and potted, providing reliable operation and outstanding vibration tolerance in tough applications.

Position transmitter specifications			
	Standard transmitter (5_)	High performance transmitter (7_)	Digital transmitter (T_)
Output	2-wire 4-20 mA	2-wire 4-20 mA	2-wire 4-20 mA
Supply source	10 - 40 VDC	10 - 40 VDC	10 - 40 VDC
Indication	None	None	Red/Green LED*
Span range*	35° to 270°	35° to 270°	35° to 320°
Maximum loading	700 ohms @ 24 VDC	700 ohms @ 24 VDC	683 ohms @ 24 VDC
Refresh rate	< 1 ms	< 1 ms	< 5 ms
Linearity error	+/-0.85°	+/-0.35°	+/-0.35°
Cycle life	2 million rotations	50 million rotations	Unlimited
Vibration tolerance	Acceptable	Outstanding	Outstanding

\* Open / Closed LED position indication and calibration status diagnostics

**Electrical schematic**



Position transmitter



Digital transmitter

# Sensors and communications

## Dual module system

The Quartz series is available with the dual module in its various configurations. Two solid state sensors and/or communications and other electronics are sealed in for the ultimate in reliability and convenience. All dual module versions have a five year warranty.



### Switching and sensor specifications

#### SST switching sensors (35)

Configuration	(2) SST solid state sensors Wire terminations for one or two solenoids
Operations	Normally open (NO) <i>for Normally closed (NC), consult factory</i>
Maximum current inrush	1.0 amp
Maximum current continuous	0.1 amp
Minimum on current	0.5 mA
Maximum leakage current	0.25 mA (AC) 0.15 mA (DC)
Voltage range	20 - 250 VAC 8 - 250 VDC
Maximum voltage drop	6.5 volts @ 10 mA 7.2 volts @ 100 mA

#### Wiring diagram (35)

### Sensor specifications

#### NAMUR sensor (45)

Configuration	(2) NAMUR sensors (EN 60947-5-6; I.S.) Wire terminations for one or two solenoids
Operation	Normally closed NAMUR sensors (solid state)
Voltage range	5 - 25 VDC
Current ratings	Target on <1 mA Target off >3 mA

#### Wiring diagram (45)

### Valve Communication Terminal (VCT) specifications

#### DeviceNet™ (92)

Configuration	(2) Discrete inputs (open and closed) (2) Power outputs (solenoids) (1) 4-20 mA auxiliary analog input, 10-bit resolution; no additional power source required
Transmission rate	Software selectable 125K, 250K or 500K baud
Messaging	Polling, cyclic and change of state
Outputs	4 watts @ 24 VDC outputs combined
Outputs, voltage	24 VDC (with input voltage ranging from 10 - 24 VDC)
Other features	Predetermined output fail state

#### Wiring diagram (92)

# Sensors and communications

## Valve Communication Terminal (VCT) specifications

### AS-Interface (96)

Configuration	(2) Discrete sensor inputs (2) Auxiliary discrete inputs (2) Power outputs (solenoids)
Maximum current	160 mA, both outputs combined
Auxiliary inputs	24 VDC @ 2 mA (self-powered)
Output	4 watts @ 24 VDC both outputs combined
Outputs, voltage	21 - 26 VDC
Configuration code	ID=F, IO=4; user defined (4DI/2DO)
AS-i version	3.0
Devices per network	31

### Wiring diagram (96)

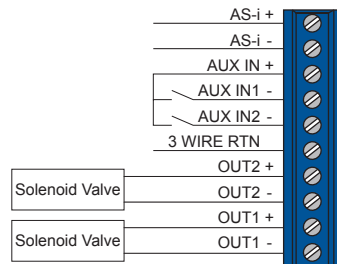

### AS-Interface VCT with extended addressing (97)

Configuration	(2) Discrete sensor inputs (2) Auxiliary discrete inputs (1) Power output (solenoid)
Maximum current	100 mA
Auxiliary inputs	24 VDC @ 2 mA (self-powered)
Output	2 watts @ 24 VDC
Output, voltage	21 - 26 VDC
Configuration code	ID=A, IO=4; user defined (4DI/1DO)
AS-i version	3.0
Devices per network	62

### Wiring diagram (97)

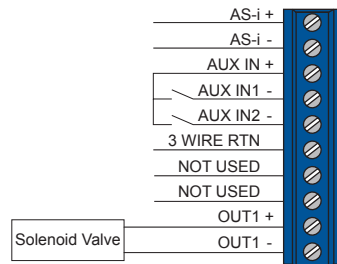

## Valve Communication Terminal (VCT) specifications

### Foundation Fieldbus VCT, bus powered (93)

Configuration	(2) Discrete Inputs (2) Power outputs (solenoids) Multiple DI/DO blocks or modified output block
Outputs	2 mA @ 6.5 VDC each current limited to 2 mA (bus powered)
Devices per network	Max of 16 devices recommended

### Wiring diagram (93)

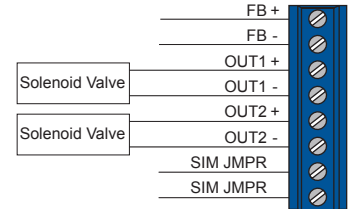

# Sensors and switches

## Maxx-Guard proximity switch

Maxx-Guard hermetically-sealed switches are suitable for computer input circuits and general purpose applications. SPDT tungsten contacts are designed for 125 VAC computer inputs and 240 VAC moderate power applications. SPDT rhodium contacts are suitable for both 24 VDC and 120 VAC computer inputs. SPST ruthenium contacts are ideal for either 24 VDC or 125 VAC low power computer inputs.



Maxx-Guard proximity switch Single-Pole Single-Throw (SPST)	
<b>J switch</b>	
Configuration	SPST NO; passive (intrinsically safe)
Electrical ratings	0.10 amp @ 10 - 30 VDC
Maximum voltage drop	0.1 volts @ 10 mA 0.5 volts @ 100 mA
Contact composition	Ruthenium
<b>P switch</b>	
Configuration	SPST NO
Electrical ratings	0.15 amp @ 125 VAC/30 VDC
Maximum voltage drop	0.1 volts @ 10 mA 0.5 volts @ 100 mA
Contact composition	Ruthenium

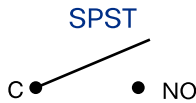

Specifications	
Temperature range	-40° C to 80° C (-40° F to 176° F)
Seal	Hermetically-sealed
Operating life	5 million cycles
Warranty	Two years

Maxx-Guard proximity switch Single-Pole Double-Throw (SPDT)	
<b>G switch</b>	
Configuration	SPDT
Electrical ratings	0.2 amp @ 120 VAC 0.30 amp @ 24 VDC
Maximum voltage drop	0.1 volts @ 10 mA 0.5 volts @ 100 mA
Contact composition	Rhodium
<b>H switch</b>	
Configuration	SPDT
Electrical ratings	240 volts max; 3 amps max 100 watts max; 2.0 watts min
Maximum voltage drop	0.1 volts @ 10 mA 0.5 volts @ 100 mA
Contact composition	Tungsten
<b>M switch</b>	
Configuration	SPDT; passive (intrinsically safe)
Electrical ratings	0.10 amp @ 10 - 30 VDC
Maximum voltage drop	0.1 volts @ 10 mA 0.5 volts @ 100 mA
Contact composition	Rhodium
<b>S switch</b>	
Configuration	SPDT (LED)
Electrical ratings	0.1 amp @ 120 VAC 0.1 amp @ 24 VDC
Maximum voltage drop	3.5 volts @ 10 mA 6.5 volts @ 100 mA
Contact composition	Rhodium





## Sensors and switches

### Mechanical switch (SPDT)

Low cost single-pole double-throw mechanical switches with silver contacts are recommended for high power 125 VAC applications. Gold contacts may be used in 24 VDC computer input applications when cycle life does not exceed 100,000 operations.

#### Mechanical switch (SPDT)

##### Silver contacts (\_V switch)

Electrical ratings 10 amp @ 125/250 VAC  
0.5 amp @ 125 VDC

Operating life 400,000 cycles

Not recommended for electrical circuits operating at less than 20 mA @ 24 VDC.

##### Gold contacts (\_W switch)

Electrical ratings 1 amp @ 125 VAC  
0.5 amp @ 30 VDC

Operating life 100,000 cycles



### Mechanical switch (DPDT)

Double-pole double-throw mechanical switches enable two electrical circuits to be activated simultaneously. Each switch circuit is electrically isolated from the other. As with standard silver contacts, DPDT switches are designed to operate in high-power applications.

#### Mechanical switch (DPDT)

##### 14 switch

Electrical ratings 4.5 amp @ 125/250 VAC, 24 - 125 VDC

Operating life 250,000 (VAC), 100,000 (VDC) cycles

Not recommended for electrical circuits operating at less than 20 mA @ 24 VDC.

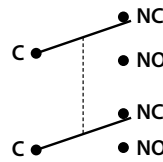

### SST switching sensor

Solid state SST proximity sensors are ideal for use in AC and DC computer input circuits.

#### SST switching sensors

##### \_X switch

Operation NO/NC (cam selectable)

Maximum current  
Inrush 1.0 amps @ 125 VAC/VDC  
Continuous 0.1 amps @ 125 VAC/VDC

Minimum on current 2.0 mA

Leakage current Less than 0.50 mA

Voltage range 24 - 125 VAC  
8 - 125 VDC

Maximum voltage drop 6.5 volts @ 10 mA  
7.5 volts @ 100 mA

Operating life Unlimited

Warranty Five years



### Model selector

**SERIES**

QX Explosionproof dual modules and VCTs

**FUNCTIONS**

**Sensor/switching modules (proximity type)**

33 SST NO switching sensor dual module *[old]*

35 SST Universal NO switching sensor dual module *[new]*

44 NAMUR dual module *[old]* (EN 60947-5-6; I.S.)

45 NAMUR dual module *[new]* (EN 60947-5-6; I.S.)

**Valve Communication Terminals (VCTs)**

92 DeviceNet™

93 Foundation Fieldbus (bus powered; I.S.)

96 AS-Interface

97 AS-Interface (with extended addressing)

**ENCLOSURE**

B Aluminum North American (NEC/CEC)

K Aluminum International (IEC)

G Aluminum Brazilian

J\* Stainless steel North American (NEC/CEC)

N\* Stainless steel International (IEC)

W\* Stainless steel Brazilian

\* Available with 03 or 06 conduit entry only

**CONDUIT ENTRIES**

02 (1) ¾" NPT & (1) ½" NPT

03 (1) ¾" NPT & (2) ½" NPT

05 (2) M20

06 (3) M20

**OUTPUT**

S Short visual indicator

N Extended visual indicator

H Metso "H" coupler

**VISUAL INDICATOR** *[see chart on page 15]*

DM Red closed/green open

NM Green closed/red open

SM T-1 three way flow path

TM T-2 three way flow path

UM T-3 three way flow path

VM T-4 three way flow path

WM T-5 three way flow path

OM No indication

XM Special

AM Continuous

Model number example

QX 35 B 02 N DM - OPTIONAL

**MODEL NUMBER**      **PARTNERSHIP ID**

Mounting hardware required and sold separately.      Some models may include 5-digit identification suffix.

### Model selector

**SERIES**

QX Explosionproof proximity switches

**FUNCTIONS**

**Sensors**

2E (2) P+F special 3-wire NPN sensor

2F (2) PNP solid state 3-wire P+F sensor

2G (2) SPDT Maxx-Guard (low current)

2H (2) SPDT Maxx-Guard (3 amp)

2L (2) SPST Maxx-Guard (LED)

2P (2) SPST Maxx-Guard

2S (2) SPDT Maxx-Guard (LED)

4G (4) SPDT Maxx-Guard (low current)

4H (4) SPDT Maxx-Guard (3 amp)

4L (4) SPST Maxx-Guard (LED)

4P (4) SPST Maxx-Guard

4S (4) SPDT Maxx-Guard (LED)

**ENCLOSURE**

B Aluminum North American (NEC/CEC)

K Aluminum International (IEC)

G Aluminum Brazilian

J\* Stainless steel North American (NEC/CEC)

N\* Stainless steel International (IEC)

W\* Stainless steel Brazilian

\* Available with 03 or 06 conduit entry only

**CONDUIT ENTRIES**

02 (1) ¾" NPT & (1) ½" NPT

03 (1) ¾" NPT & (2) ½" NPT

05 (2) M20

06 (3) M20

**OUTPUT**

S Short visual indicator

N Extended visual indicator

H Metso "H" coupler

**VISUAL INDICATOR** *[see chart on page 15]*

DM Red closed/green open

NM Green closed/red open

SM T-1 three way flow path

TM T-2 three way flow path

UM T-3 three way flow path

VM T-4 three way flow path

WM T-5 three way flow path

OM No indication

XM Special

AM Continuous

Model number example

QX 2G K 02 N DM - OPTIONAL

**MODEL NUMBER**      **PARTNERSHIP ID**

Mounting hardware required and sold separately.      Some models may include 5-digit identification suffix.

**Model selector**

**SERIES**  
 QX Explosionproof mechanical switches and position transmitters

**FUNCTIONS**

**Mechanical switches**

2V (2) SPDT switches  
 2W (2) SPDT switches, gold contact  
 4V (4) SPDT switches  
 4W (4) SPDT switches, gold contact  
 14 (2) DPDT switches

**Position transmitters**

50 Standard with no switches  
 5G Standard with (2) SPDT Maxx-Guard (low current)  
 5V Standard with (2) SPDT mechanical switches  
 5W Standard with (2) SPDT mechanical switches, gold contact  
 53 Standard with SST (33) NO switching sensor dual module  
 54 Standard with NAMUR (44) dual module (EN 60947-5-6; I.S.)  
 70 High performance (HP) with no switches  
 7G HP with (2) SPDT Maxx-Guard (low current)  
 73 HP with SST NO (33) switching sensor dual module  
 74 HP with NAMUR (44) dual module (EN 60947-5-6; I.S.)  
 TO 4-20 mA non-contact with no switches  
 TT 4-20 mA non-contact with SST (35) NO switching sensor dual module  
 TR 4-20 mA non contact with NAMUR (45) dual module (EN 60947-5-6; I.S.)

**ENCLOSURE**

B Aluminum North American (NEC/CEC)  
 K Aluminum International (IEC)  
 G Aluminum Brazilian  
 J\* Stainless steel North American (NEC/CEC)  
 N\* Stainless steel International (IEC)  
 W\* Stainless steel Brazilian  
 \* Available with 03 or 06 conduit entry only

**CONDUIT ENTRIES**

02 (1) 3/4" NPT & (1) 1/2" NPT  
 03 (1) 3/4" NPT & (2) 1/2" NPT  
 05 (2) M20  
 06 (3) M20

**OUTPUT**

S Short visual indicator  
 N Extended visual indicator  
 H Metso "H" coupler

**VISUAL INDICATOR [see chart on page 15]**

DM Red closed/green open  
 NM Green closed/red open  
 SM T-1 three way flow path  
 TM T-2 three way flow path  
 UM T-3 three way flow path  
 VM T-4 three way flow path  
 WM T-5 three way flow path  
 OM No indication  
 XM Special  
 AM Continuous

Model number example  
 QX 2V B 02 N DM - OPTIONAL

**MODEL NUMBER**      **PARTNERSHIP ID**

Mounting hardware required and sold separately.      Some models may include 5-digit identification suffix.

**Model selector**

**SERIES**  
 QG General purpose mechanical switches (clear cover)

**FUNCTION**

**Mechanical switches**

2V (2) SPDT switches  
 2W (2) SPDT switches, gold contact  
 4V (4) SPDT switches  
 4W (4) SPDT switches, gold contact  
 14 (2) DPDT switches

**ENCLOSURE**

P General purpose, universal

**CONDUIT ENTRIES**

02 (1) 3/4" NPT & (1) 1/2" NPT  
 03 (1) 3/4" NPT & (2) 1/2" NPT  
 05 (2) M20  
 06 (3) M20

**OUTPUT**

S Short visual indicator  
 N Extended visual indicator  
 H Metso "H" coupler

**VISUAL INDICATOR [see chart on page 15]**

DM Red closed/green open  
 NM Green closed/red open  
 SM T-1 three way flow path  
 TM T-2 three way flow path  
 UM T-3 three way flow path  
 VM T-4 three way flow path  
 WM T-5 three way flow path  
 OM No indication  
 XM Special  
 AM Continuous

Model number example  
 QG 2V P 02 N DM - OPTIONAL

**MODEL NUMBER**      **PARTNERSHIP ID**

Mounting hardware required and sold separately.      Some models may include 5-digit identification suffix.

**Model selector**

**SERIES**

QN Nonincendive dual modules and VCTs

**FUNCTIONS**

**Sensor/switching** *[proximity type]*

- 33 SST NO switching sensor dual module *[old]*
- 35 SST Universal NO switching sensor dual module *[new]*

**Valve Communication Terminals (VCTs)**

- 92 DeviceNet™
- 93 Foundation Fieldbus (bus powered) *[intrinsically safe]*
- 96 AS-Interface
- 97 AS-Interface with extended addressing

**ENCLOSURE**

**Clear cover**

- P North American (NEC/CEC)
- A International (IEC)

**CONDUIT ENTRIES**

- 02 (1) 3/4" NPT & (1) 1/2" NPT
- 03 (1) 3/4" NPT & (2) 1/2" NPT
- 05 (2) M20
- 06 (3) M20

**OUTPUT**

- S Short visual indicator
- N Extended visual indicator
- H Metso "H" coupler

**VISUAL INDICATOR** *[see chart on page 15]*

- DM Red closed/green open
- NM Green closed/red open
- SM T-1 three way flow path
- TM T-2 three way flow path
- UM T-3 three way flow path
- VM T-4 three way flow path
- WM T-5 three way flow path
- OM No indication
- XM Special
- AM Continuous

Model number example

QN 35 P 02 S DM - OPTIONAL

**MODEL NUMBER**

**PARTNERSHIP ID**

Mounting hardware required and sold separately.

Some models may include 5-digit identification suffix.

**Model selector**

**SERIES**

QN Nonincendive proximity switches

**FUNCTION**

**Sensors**

- 2F (2) PNP solid state 3-wire P+F sensor
- 2G (2) SPDT Maxx-Guard (low current)
- 2H (2) SPDT Maxx-Guard (3 amp)
- 2L (2) SPST Maxx-Guard (LED)
- 2P (2) SPST Maxx-Guard
- 2S (2) SPDT Maxx-Guard (LED)
- 4G (4) SPDT Maxx-Guard (low current)
- 4H (4) SPDT Maxx-Guard (3 amp)
- 4L (4) SPST Maxx-Guard (LED)
- 4P (4) SPST Maxx-Guard
- 4S (4) SPDT Maxx-Guard (LED)
- 4X (4) SST sensor (LED)

**ENCLOSURE**

**Clear cover**

- P North American (NEC/CEC)
- A International (IEC)

**CONDUIT ENTRIES**

- 02 (1) 3/4" NPT & (1) 1/2" NPT
- 03 (1) 3/4" NPT & (2) 1/2" NPT
- 05 (2) M20
- 06 (3) M20

**OUTPUT**

- S Short visual indicator
- N Extended visual indicator
- H Metso "H" coupler

**VISUAL INDICATOR** *[see chart on page 15]*

- DM Red closed/green open
- NM Green closed/red open
- SM T-1 three way flow path
- TM T-2 three way flow path
- UM T-3 three way flow path
- VM T-4 three way flow path
- WM T-5 three way flow path
- OM No indication
- XM Special
- AM Continuous

Model number example

QN 2G P 02 N DM - OPTIONAL

**MODEL NUMBER**

**PARTNERSHIP ID**

Mounting hardware required and sold separately.

Some models may include 5-digit identification suffix.

**Model selector**

**SERIES**

QN Intrinsically safe (I.S.) proximity switches and position transmitters

**FUNCTIONS**

**Sensor/switching modules (proximity type)**

- 44 NAMUR dual module [old] (EN 60947-5-6; I.S.)
- 45 NAMUR dual module [new] (EN 60947-5-6; I.S.)

**Sensor**

- 2A (2) P+F special safety amplifier
- 2J (2) SPST (passive)
- 2M (2) SPDT (passive)
- 2N (2) P+F NAMUR sensors
- 4J (4) SPST (passive)
- 4M (4) SPDT (passive)
- 4N (4) P+F NAMUR sensors

**Position transmitters**

- 50 Standard with no switches
- 54 Standard with NAMUR (44) dual module (EN 60947-5-6; I.S.)
- 70 High performance (HP) with no switches
- 74 High performance (HP) with NAMUR (44) dual module (EN 60947-5-6; I.S.)

**ENCLOSURE**

**Clear cover**

- P North American (NEC/CEC)
- A International (IEC)

**Aluminum cover [not explosion proof]**

- B North American (NEC/CEC)
- K International (IEC)
- G Brazilian

**CONDUIT ENTRIES**

- 02 (1) 3/4" NPT & (1) 1/2" NPT
- 03 (1) 3/4" NPT & (2) 1/2" NPT
- 05 (2) M20
- 06 (3) M20

**OUTPUT**

- S Short visual indicator
- N Extended visual indicator
- H Metso "H" coupler

**VISUAL INDICATOR [see chart on page 15]**

- DM Red closed/green open
- NM Green closed/red open
- SM T-1 three way flow path
- TM T-2 three way flow path
- UM T-3 three way flow path
- VM T-4 three way flow path
- WM T-5 three way flow path
- OM No indication
- XM Special
- AM Continuous

Model number example

QN 45 P 02 N DM - OPTIONAL

**MODEL NUMBER**  
Mounting hardware required and sold separately.

**PARTNERSHIP ID**  
Some models may include 5-digit identification suffix.

**Model selector**

**SERIES**

QN Nonincendive proximity switches and position transmitters

**FUNCTIONS**

**Position transmitters**

- 50 Standard with no switches
- 5G Standard with (2) SPDT Maxx-Guard (low current)
- 53 Standard with SST (33) NO switching sensor dual module
- 70 High performance (HP) with no switches
- 7G High performance (HP) with (2) SPDT Maxx-Guard (low current)
- 73 High performance (HP) with SST (33) NO switching sensor dual module
- TO 4-20 mA non-contact with no switches
- TT 4-20 mA non-contact with SST (35) NO switching sensor dual module
- TR 4-20 mA non-contact with NAMUR (45) dual module (EN 60947-5-6; I.S.)

**ENCLOSURE**

**Clear cover**

- P North American (NEC/CEC)
- A International (IEC)

**CONDUIT ENTRIES**

- 02 (1) 3/4" NPT & (1) 1/2" NPT
- 03 (1) 3/4" NPT & (2) 1/2" NPT
- 05 (2) M20
- 06 (3) M20

**OUTPUT**

- S Short visual indicator
- N Extended visual indicator
- H Metso "H" coupler

**VISUAL INDICATOR [see chart on page 15]**

- DM Red closed/green open
- NM Green closed/red open
- SM T-1 three way flow path
- TM T-2 three way flow path
- UM T-3 three way flow path
- VM T-4 three way flow path
- WM T-5 three way flow path
- OM No indication
- XM Special
- AM Continuous

Model number example

QN 50 P 02 N DM - OPTIONAL

**MODEL NUMBER**  
Mounting hardware required and sold separately.

**PARTNERSHIP ID**  
Some models may include 5-digit identification suffix.

## Specifications

### Materials of construction

Housing & cover	Epoxy-coated anodized marine grade aluminum or stainless steel
Clear cover & indicator	Lexan® polycarbonate
Elastomer seals	Buna-N; optional EPDM
Drive shaft	Stainless steel
Drive bushing	Bronze, oil impregnated
Fasteners	Stainless steel

### Temperature ratings

Mechanical components	-40° C to 80° C (-40° F to 176° F)
Dual modules	-40° C to 80° C (-40° F to 176° F)
Maxx-Guard & SST	-40° C to 80° C (-40° F to 176° F)

### Warranty

Mechanical components	Two years
SST & dual modules	Five years

Lexan® is a registered trademark of General Electric Corporation.

## Ratings

Explosionproof <i>(Ex d, Zone 1 or Class I and II, Div. 1)</i>	QX models*
Nonincendive <i>(Class I and II, Div. 2)</i>	QN models*
Intrinsically safe <i>(Ex ia, Zone 0 or Class I and II, Div. 1)</i>	Functions 44, 45, 93, _A, _J, _M and _N*

### Enclosure protection

NEMA 4, 4X and 6	All models
Ingress Protection 67	All models

### Approvals\*

See StoneL.com/approvals

\* Only models listed on StoneL's official website are approved per specific rating.

## Dimensions mm [Inches]

### Output option "S" - Short visual indicator

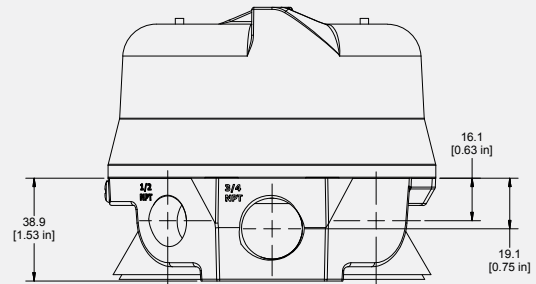
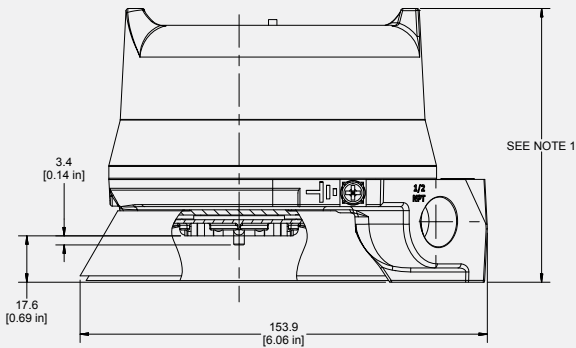

### Output option "N" - Extended visual indicator

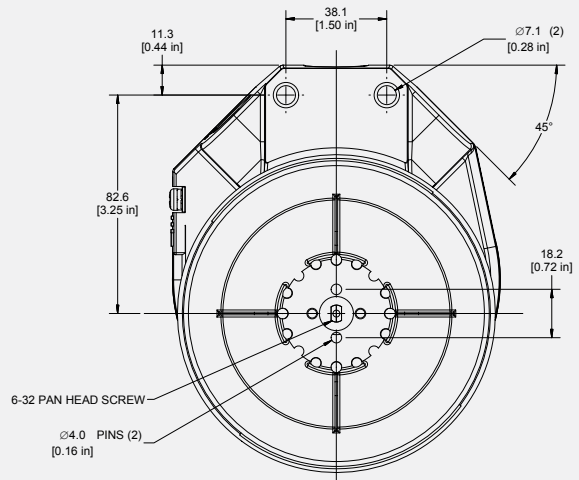
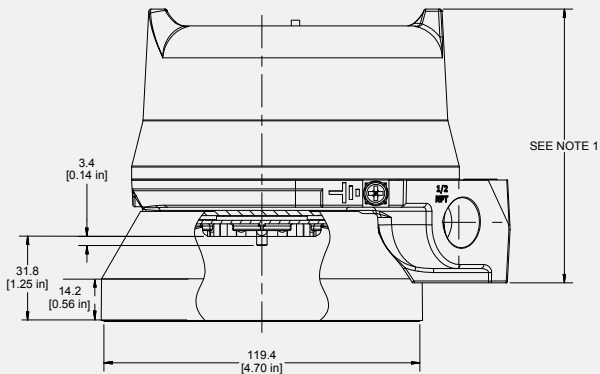



#### NOTE 1

Cover height varies based on model number.  
Dual module and 2-switch models use short covers.

- Short cover = 102 mm [4.0"]
- Medium cover = 123.4 mm [4.86"]
- Tall cover = 155.4 mm [6.12"]

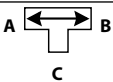
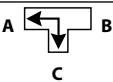
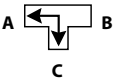
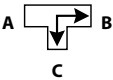
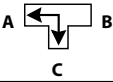
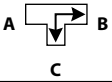
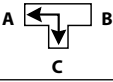
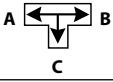
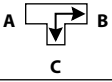
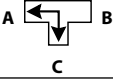
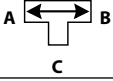
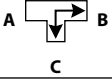
## Visual indicator designations

DESIGNATION	0°	90°	180°
<b>D</b>	<b>RED CLOSED</b>	<b>GREEN OPEN</b>	
<b>N</b>	<b>GREEN CLOSED</b>	<b>RED OPEN</b>	
<b>S</b>			
<b>T</b>			
<b>U</b>		<b>CLOSED</b>	
<b>V</b>			
<b>W</b>			
<b>A</b>			
<b>X</b>	Specialty configuration - please consult factory		

**Metso Flow Control Inc.**

**Europe**, Vanha Porvoontie 229, P.O. Box 304, FI-01301 VANTAA, Finland.  
Tel. +358 20 483 150. Fax +358 20 483 151

**North America**, 26271 US Hwy 59, Fergus Falls, MN 56537, USA.  
Tel. +1 218 739 5774. Fax +1 218 739 5776

**South America**, Av. Independência, 2500- Iporanga, 18087-101, Sorocaba-São Paulo, Brazil.  
Tel. +55 15 2102 9700. Fax +55 15 2102 9748/49

**Asia Pacific**, Haw Par Centre #06-01, 180 Clemenceau Avenue, Singapore 239922.  
Tel. +65 6511 1011. Fax +65 6250 0830

**China**, 11/F, China Youth Plaza, No.19 North Rd of East 3rd Ring Rd, Chaoyang District,  
Beijing 100020, China. Tel. +86 10 6566 6600. Fax +86 10 6566 2583.

**Middle East**, Roundabout 8, Unit AB-07, P.O. Box 17175, Jebel Ali Freezone, Dubai,  
United Arab Emirates. Tel. +971 4 883 6974. Fax +971 4 883 6836

**[www.metso.com/valves](http://www.metso.com/valves)**

Subject to change without prior notice.

