

B34 Series Regulator

Commercial and Industrial Regulator

Appropriate for many commercial and industrial uses such as gas engines, burners, furnaces and boilers. The rapid response of the B34 is particularly well-suited for mid-range applications where quick on/off loads cause shock problems.

MODEL DESCRIPTION

» B34N

The B34N is a spring-loaded, self-operated regulator with no internal relief, an adjustable loading ring for controlled boost at higher flows, and a precision breather opening to ensure proper stability for all conditions. This regulator can be used on low or intermediate inlet pressures where an internal relief or other type of over-pressure protection device is not required.

» B34R

The B34R is the internal relief version of the B34 series. This model features an adjustable loading ring for controlled boost at higher flows and a 1" internal relief valve.

» B34DN

The B34DN is a standard B34N with a closed-throat, downstream control tap on the bottom of the diaphragm case, and no internal relief capabilities. This unit is used when it is desirable to control the regulator from points other than the valve outlet. Since the control point is no longer at the outlet of the valve body, the regulator does not boost, but all the capacity tables are the same as the R and N models.

» B34DR

The B34DR is the same as the B34DN, except it has internal relief similar to the B34R.

» B34MN

The B34MN is very similar to the B34DN with a closed-throat, downstream control line and no internal relief capabilities, except for an O-ring seal on the valve body stem through the throat to assure positive downstream control when installed ahead of a downstream regulator. Used in a series monitoring installation as the upstream regulator, this unit gives customers an operating device that assumes control over an operating regulator when failure is sensed by the control line of the monitor. This series system assures maximum safety with uninterrupted service. The monitor regulator is set to take over control from the operating regulator with only a slight increase in outlet pressure.

» B34MR

The B34MR is the same as the B34MN, except it has internal relief similar to the B34R.

FEATURES

- » Interchangeable brass orifice
- » 78 in² of diaphragm area
- » Spring-loaded internal relief valve assembly
- » Field interchangeable adjustment spring
- » Controlled size breather orifice eliminates pulsation and provides normal action at low flows
- » Wide range of valve body sizes including NPT and flange connections

BENEFITS

- » Economical
- » Protects equipment from shock damage
- » Large 12" diaphragm for better outlet pressure control
- » Unmatched overpressure protection with internal monitor (IM) plus internal relief option

B34 SERIES COMMERCIAL REGULATOR

SHIPPING WEIGHT

One regulator per box Box weight: 24 lbs.

B34 DIMENSIONS (INCHES)

Valve Body	A	B	C	D	E	F	G	H	R
1-1/4, 1-1/2, or 2 NPT	5-3/4	2-7/8	8-11/16	12-3/4	4-5/16	10	2-3/16	4-1/2	2-1/4
2 Flanged	10	5	8-11/16	12-3/4	4-5/16	10	2-3/16	5-1/2	3-1/4
3 Flanged	10	5	8-11/16	12-3/4	4-5/16	10	2-3/16	5-1/2	3-1/4

► Screwed Valve Body

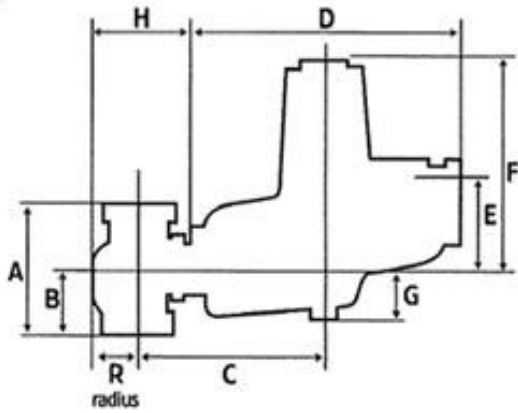

► Flanged Valve Body

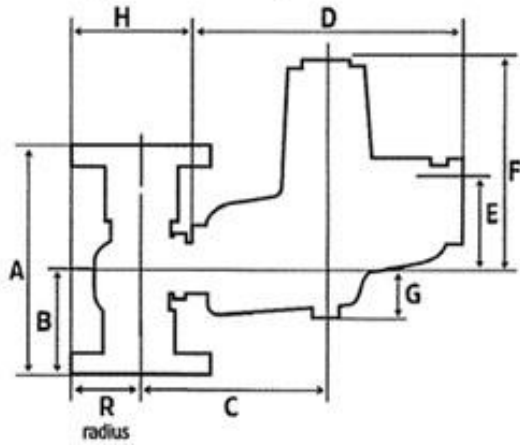

SPRING DATA, SPRING COLOR OUTLET PRESSURE RANGE*

Models B34 N, R, M, D

Colors	Part Number	Outlet Pressure Range
Orange	762341	3.0" w.c. - 5.0" w.c.
Brown	762351	4.0" w.c. - 6.5" w.c.
Green	762353	5.0" w.c. - 8.0" w.c.
Black	762355	6.5" w.c. - 13.0" w.c.
Purple	765365	9.1" w.c. - 20.8" w.c.
Blue	762357	15.0" w.c. - 28.0" w.c.
Silver	762359	1.0 PSIG - 2.0 PSIG
Yellow	762361	2.0 PSIG - 4.5 PSIG
Red-nested	762671	4.0 PSIG - 5.5 PSIG
White-nested	762673	4.8 PSIG - 7.3 PSIG

*Note Ranges are approximations, please contact manufacturer to obtain the best spring for your application.

ORIFICE DATA, WIDE OPEN FLOW COEFFICIENTS AND MAXIMUM PRESSURES

Orifice Size (inches)	K-Factor	Maximum Operating Inlet (PSIG)			Maximum Emergency Inlet Pressure (PSIG)	Maximum Emergency Outlet Pressure (PSIG)
		in. w.c. Delivery N & R Models	in. w.c. Delivery D & M Models	PSIG Delivery All Models	All Deliveries All Models	All Deliveries All Models
1/4	125	125	175	175	300	60
1/4 x 3/8	125	125	125	175	300	
3/8	290	125	125	175	300	
3/8 x 1/2	305	125	125	150	300	
1/2	500	75	125	150	300	
1/2 x 5/8	550	60	125	150	300	
5/8	700	60	125	150	300	
5/8 x 3/4	750	60	100	150	300	
3/4	900	60	100	150	300	
3/4 x 7/8	950	60	100	150	230	
7/8	1200	60	100	150	230	
7/8 x 1	1245	25	100	150	230	

OPERATING TEMPERATURE RANGE

- 20°F to 150°F
- Silicone valve seats available for applications below -20°F

ADDITIONAL SPECIFICATIONS

Available Vent Sizes	1"
Loading Ring Position	M & D Models - 0° R & N Models for <1 PSIG set point - 21°; >1 PSIG set point - 0°
Other Available Options	Seal wire to indicate unapproved tampering 1/8" pipe plug tap on upstream side of valve body

COMPLIANCE

The B34R (internal relief model) compliance with ANSI Z21.80, Line Pressure Regulators

Model B34R used with a 1" vent connection is compliant with ANSI Z21.80 in the configurations noted and shown in the following tables:

With inlet pressures up to 2 PSIG, the B34R is compliant in any configuration.

With inlet pressures up to 5 PSIG

Orifice Size	Set Point	Maximum Vent Line Length (ft.)*	Number of Elbows**
1/4"	Up to 1 PSIG	50	4 or less
1/4" x 3/8"	Up to 1 PSIG	50	4 or less
3/8"	Up to 14" w.c.	50	4 or less
3/8" x 1/2"	Up to 14" w.c.	50	4 or less
1/2"	Up to 14" w.c.	25	4 or less
1/2" x 5/8"	Up to 14" w.c.	10	4 or less
5/8"	Up to 14" w.c.	10	4 or less
5/8" x 3/4"	Up to 14" w.c.	No vent line	No vent line
3/4"	Up to 14" w.c.	No vent line	No vent line

*Clean 1" black steel pipe

**For each elbow greater than 4 elbows, subtract 2.6 ft. from the maximum vent line length.

With inlet pressures up to 10 PSIG

Orifice Size	Set Point	Maximum Vent Line Length (ft.)*	Number of Elbows**
1/4"	Up to 1 PSIG	50	4 or less
1/4" x 3/8"	Up to 1 PSIG	50	4 or less
3/8"	Up to 14" w.c.	30	4 or less
3/8" x 1/2"	Up to 14" w.c.	25	4 or less
1/2"	Up to 14" w.c.	No vent line	No vent line

*Clean 1" black steel pipe

**For each elbow greater than 4 elbows, subtract 2.6 ft. from the maximum vent line length.

CONSTRUCTION

Itron takes pride in delivering products with the utmost concern for safety, quality, and customer satisfaction.

Construction materials

Valve body	High tensile strength cast iron
Orifice	Brass
Valve seat	Buna-N or silicone (for temperatures below -20°F)
Valve stem	Plated Steel
Lever pin	Stainless steel
Lever	Zinc and dichromate plated steel
Stem Guide	Stainless Steel
Upper diaphragm plate	Zinc and dichromate plated steel
Lower diaphragm plate	Die cast aluminum
Diaphragm	Buna-N and nylon
Vent valve/seat	Delrin/Buna-N
Vent screen	Stainless steel
Adjustment ferrule	Die cast aluminum
Seal cap	Die cast aluminum
Diaphragm case	Die cast aluminum

VALVE BODY SIZES (INCHES)

Inlet	Outlet	Screwed	Flanged
1-1/4	1-1/4	X	---
1-1/4	1-1/2	X	---
1-1/4	2	X	---
1-1/2	1-1/2	X	---
1-1/2	2	X	---
2	2	X	X
3	3	---	X

Note: X indicates that the valve body is available in that configuration.

B34 IM VALVE BODY SIZES (INCHES)

Inlet	Outlet	Screwed	Flanged
1-1/4	1-1/4	X	--
1-1/4	1-1/2	X	---
1-1/4	2	X	---
1-1/2	1-1/2	X	---
1-1/2	2	X	---
2	2	X	X
3	3	---	X*

*With 2" bore

Note: X indicates that the valve body is available in that configuration

CORRECTION FACTORS FOR NON-NATURAL GAS APPLICATIONS

The B34 may be used to control gases other than natural gas. To determine the capacity for gases other than natural gas, multiply the values within the capacity tables by a correction factor. The table below lists the correction factors for some of the more common gases:

Gas Type	Specific Gravity	Correction Factor (CF)
Air	1.00	0.77
Butane	2.01	0.55
Carbon Dioxide (Dry)	1.52	0.63
Carbon Monoxide (Dry)	0.97	0.79
Natural Gas	0.60	1.00
Nitrogen	0.97	0.79
Propane	1.53	0.63
Propane-Air Mix	1.20	0.71

To calculate the correction factor for gases not listed in the table above, use the gases' specific gravity and insert it in the formula listed below:

$$\text{Correction Factor (CF)} = \sqrt{\frac{SG_1}{SG_2}}$$

Where:

SG_1 = Specific gravity of the gas in which the capacity is published.

SG_2 = Specific gravity of the gas to be controlled.

Wide Open Flow Calculations

For wide-open orifice flow calculations use the following equations:

$$\text{For } \frac{P_1}{P_2} < 1.89 \text{ use: } Q = K\sqrt{P_2(P_1 - P_2)}$$

$$\text{For } \frac{P_1}{P_2} > 1.89 \text{ use: } Q = \frac{KP_1}{2}$$

Where: P_1 = Absolute Inlet Pressure (PSIA)

P_2 = Absolute Outlet Pressure (PSIA)

Q = Flow Rate (SCFH)

K = Orifice Coefficient (SCFH/PSI)

B34 SERIES COMMERCIAL REGULATOR, MODELS N, R, M, AND D

7" w.c. (17.5 mbar) Capacity Table (1" w.c. Droop*) 2" Outlet

Capacities in SCFH of 0.6 S.G. gas; base conditions of 14.7 PSIA and 60° F.

Typical Capacity Info.

Manufacturer	Itron
Type and model	B34R
Regulator	
Inlet size:	2" NPT
Outlet size:	2" NPT
Position	11
Spring	Green

Inlet Pressure		Orifice Size									
PSIG	Bar	1/4"		1/4" x 3/8"		3/8"		3/8" x 1/2"		1/2"	
8" w.c.	0.020									325	(9.2)
10" w.c.	0.025					325	(9.2)	435	(12.3)	500	(14.2)
12" w.c.	0.030			250	(7.1)	400	(11.3)	540	(15.3)	625	(17.7)
14" w.c.	0.035	225	(6.4)	300	(8.5)	475	(13.5)	610	(17.3)	750	(21.2)
16" w.c.	0.040	250	(7.1)	350	(9.9)	550	(15.6)	700	(19.8)	800	(22.7)
18" w.c.	0.045	275	(7.8)	375	(10.6)	600	(17.0)	740	(21.0)	900	(25.5)
21" w.c.	0.052	300	(8.5)	400	(11.3)	700	(19.8)	800	(22.7)	1050	(29.7)
24" w.c.	0.060	350	(9.9)	400	(11.3)	800	(22.7)	890	(25.2)	1200	(34.0)
1	0.069	400	(11.3)	400	(11.3)	875	(24.8)	1000	(28.3)	1300	(36.8)
2	0.138	575	(16.3)	575	(16.3)	1300	(36.8)	1500	(42.5)	1900	(53.8)
3	0.207	775	(21.9)	800	(22.7)	1700	(48.1)	2000	(56.6)	2000	(56.6)
5	0.345	1000	(28.3)	1100	(31.1)	2000	(56.6)	2400	(68.0)	2400	(68.0)
10	0.69	1500	(42.5)	1700	(48.1)	3400	(96.3)	3500	(99.1)	3500	(99.1)
20	1.38	2150	(60.9)	2300	(65.1)	5000	(141.6)	5000	(141.6)	8500	(240.7)
30	2.07	2750	(77.9)	2900	(82.1)	6500	(184.1)	6500	(184.1)	10000	(283.2)
40	2.76	3450	(97.7)	3550	(100.5)	8000	(226.5)	8000	(226.5)	10000	(283.2)
50	3.45	3800	(107.6)	4100	(116.1)	9200	(260.5)	9200	(260.5)	10000	(283.2)
60	4.14	4500	(127.4)	5000	(141.6)	9500	(269.0)	10000	(283.2)	10000	(283.2)
70	4.83	4700	(133.1)	5100	(144.4)	10000	(283.2)	10000	(283.2)	10000	(283.2)
80	5.52	4900	(138.8)	6000	(169.9)	10000	(283.2)				
90	6.21	6800	(192.6)	7000	(198.2)	10000	(283.2)				
100	6.90	7400	(209.5)	7800	(220.9)	10000	(283.2)				
125	8.63	8800	(249.2)	9000	(252.0)	10000	(283.2)				
Inlet Effect ^A in. w.c. (mbar)		0.3 (0.8)		0.3 (0.8)		0.3 (0.8)		0.3 (0.8)		0.3 (0.8)	
Lock Up ^B in. w.c. (mbar)		0.3 (0.8)		0.3 (0.8)		0.3 (0.8)		0.5 (1.3)		0.5 (1.3)	

Notes:

*Individual regulator performance may vary from data shown.

A. Change in outlet pressure for 10 PSIG inlet pressure change.

B. Outlet pressure increase required for lock up.

 Do not operate orifice in shaded inlet pressure area.

 Inlet pressure is too low to deliver 7" w.c. (17.5 mbar).

7" w.c. (17.5 mbar) Capacity Table (1" Droop) 2" Outlet (continued)

Capacities in SCFH of 0.6 S.G. gas; base conditions of 14.7 PSIA and 60° F.

Inlet Pressure		Orifice Size													
PSIG	Bar	1/2" x 5/8"		5/8"		5/8" x 3/4"		3/4"		3/4" x 7/8"		7/8"		7/8" x 1"	
8" w.c.	0.020	400	(11.3)	500	(14.2)	635	(18.0)	675	(19.1)	725	(20.5)	850	(24.1)	900	(25.5)
10" w.c.	0.025	650	(18.4)	750	(21.2)	850	(24.1)	900	(25.5)	1050	(29.7)	1150	(32.6)	1225	(34.7)
12" w.c.	.030	800	(22.7)	800	(22.7)	950	(26.9)	1050	(29.7)	1100	(31.1)	1250	(35.4)	1425	(40.4)
14" w.c.	0.035	900	(25.2)	1175	(32.9)	1200	(33.6)	1250	(35.0)	1525	(42.7)	1700	(47.6)	1900	(53.2)
16" w.c.	0.040	1050	(29.4)	1175	(32.9)	1350	(37.8)	1550	(43.4)	1700	(47.6)	1950	(54.6)	2050	(57.4)
18" w.c.	0.045	1150	(32.2)	1275	(35.7)	1575	(44.1)	1750	49.0)	1825	(51.1)	2050	(57.4)	2350	(65.8)
21" w.c.	0.052	1350	(37.8)	1500	(42.5)	1750	(49.0)	1800	(50.4)	2100	(58.8)	2350	(65.8)	2700	(75.6)
24" w.c.	0.060	1450	(41.1)	1700	(48.1)	1950	(55.2)	2100	(59.9)	2250	(63.7)	2700	(76.5)	3000	(85.0)
1	0.069	1500	(42.5)	2200	(62.3)	2200	(62.3)	2300	(65.1)	2400	(68.0)	2700	(76.5)	3200	(90.6)
2	0.138	2000	(56.6)	3000	(85.4)	3300	(94.3)	3700	(104.8)	4000	(113.3)	4500	(127.4)	4700	(133.1)
3	0.207	2700	(76.5)	4000	(113.3)	4200	(118.96)	4400	(124.6)	4600	(130.3)	5200	(147.2)	6000	(170.0)
5	0.345	4000	(113.3)	5100	(144.4)	5700	(161.4)	6800	(192.6)	7000	(198.2)	7500	(212.4)	8000	(226.5)
10	0.69	5700	(161.4)	8500	(240.7)	9000	(254.9)	10000	(283.2)	10000	(283.2)	10000	(283.2)	10000	(283.2)
20	1.38	8500	(240.7)	10000	(283.2)	10000	(283.2)	10000	(283.2)	10000	(283.2)	10000	(283.2)	10000	(283.2)
30	2.07	10000	(283.2)	10000	(283.2)	10000	(283.2)	10000	(283.2)	10000	(283.2)	10000	(283.2)		
40	2.76	10000	(283.2)	10000	(283.2)	10000	(283.2)	10000	(283.2)	10000	(283.2)	10000	(283.2)		
50	3.45	10000	(283.2)	10000	(283.2)	10000	(283.2)	10000	(283.2)	10000	(283.2)	10000	(283.2)		
60	4.14	10000	(283.2)	10000	(283.2)	10000	(283.2)	10000	(283.2)	10000	(283.2)				
70	4.83														
80	5.52														
90	6.21														
100	6.90														
125	8.63														

Inlet Effect ^A in. w.c. (mbar)	0.3 (0.8)	0.4 (1.0)	0.5 (1.3)	0.5 (1.3)	0.5 (1.3)	0.6 (1.5)	0.6 (1.5)
Lock Up ^B in w.c. (mbar)	0.6 (1.5)	1.0 (2.5)	1.0 (2.5)	1.1 (2.8)	1.1 (2.8)	1.1 (2.8)	1.1 (2.8)

Notes:

*Individual regulator performance may vary from data shown.

A. Change in outlet pressure for 10 PSIG inlet pressure change.

B. Outlet pressure increase required for lock up.

 Do not operate orifice in shaded inlet pressure area.

B34 PERFORMANCE CURVES

7" w.c. Set Point

Type and model	B34R
Inlet size	2" NPT
Outlet size	2" NPT
Orifice size	1/4" x 3/8"
Spring	Green

All test results are reported at a base of 14.7 PSIA and 60° F. and with 0.6 S.G. gas.

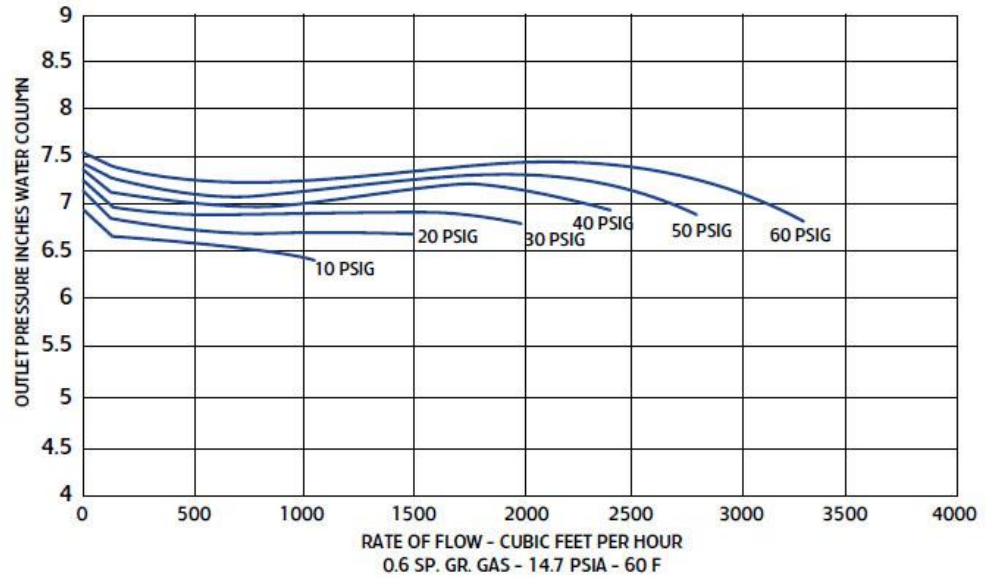

B34 RELIEF CURVES

7" w.c. Set Point

Inlet size	2" NPT
Outlet size	2" NPT
Vent size	1" NPT

All test results are reported at a base of 14.7 PSIG at 60° F and with 0.6 S.G. gas.

Regulator set at 7.0" w.c. with 40 PSIG inlet pressure at 200 SCFH.

B34R Relief Curves, Blocked Open, 7" w.c. Set Point

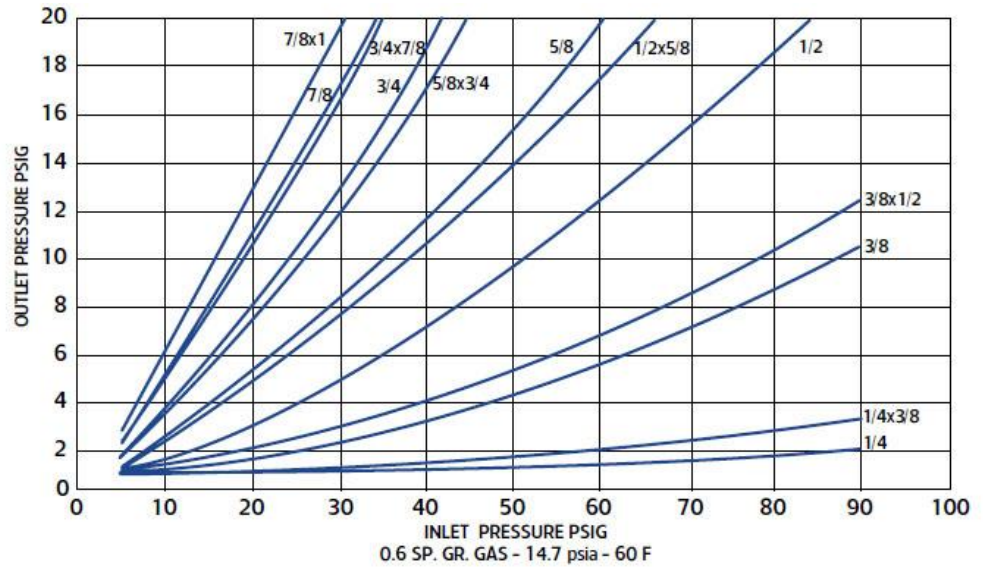

B34 SERIES COMMERCIAL REGULATOR, MODELS N, R, M, AND D

14" w.c. (35 mbar) Capacity Table (2" w.c. Droop*) 2" Outlet

Capacities in SCFH of 0.6 S.G. gas; base conditions of 14.7 PSIA and 60° F.

Typical Capacity Info.	
Manufacturer	Itron
Type and model	B34R
Regulator	
Inlet size	2" NPT
Outlet size	2" NPT
Position	11
Spring color	Purple

Inlet Pressure		Orifice Size							
		1/4"		1/4" x 3/8"		3/8"		3/8" x 1/2"	
PSIG	Bar								
16" w.c.	0.040					350	(9.9)	400	(11.3)
18" w.c.	0.045			250	(7.1)	400	(11.3)	520	(14.7)
21" w.c.	0.052	220	(6.2)	300	(8.5)	500	(14.2)	600	(17.0)
24" w.c.	0.060	260	(7.4)	370	(10.5)	550	(15.6)	750	(21.2)
1	0.069	300	(8.5)	430	(12.2)	700	(19.8)	800	(22.7)
2	0.138	550	(15.6)	600	(17.0)	1200	(34.0)	1400	(39.6)
3	0.207	700	(19.8)	750	(21.2)	1600	(44.4)	2200	(62.3)
5	0.345	900	(25.5)	1000	(28.3)	2000	(56.6)	2300	(65.1)
10	0.69	1300	(36.8)	1500	(42.5)	3000	(85.0)	3200	(90.1)
20	1.38	2100	(59.5)	2300	(65.1)	4800	(135.9)	5000	(141.6)
30	2.07	2700	(76.5)	2800	(79.3)	6700	(189.7)	6900	(195.4)
40	2.76	3400	(96.3)	3600	(101.9)	7600	(215.2)	7800	(220.9)
50	3.45	3900	(110.4)	4200	(118.9)	8700	(246.4)	9000	(254.9)
60	4.14	4500	(127.4)	4700	(133.1)	10000	(283.2)	10000	(283.2)
70	4.83	4900	(138.8)	5100	(144.4)	10000	(283.2)	10000	(283.2)
80	5.52	5400	(152.9)	5600	(158.6)	10000	(283.2)	10000	(283.2)
90	6.21	6500	(184.1)	6700	(189.7)	10000	(283.2)	10000	(283.2) _v
100	6.90	7000	(198.2)	7500	(212.4)	10000	(283.2)		
125	8.63	8500	(240.7)	9000	(254.9)	10000	(283.2)		

Inlet Effect A in. w.c. (mbar)	0.4 (0.8)	0.3 (0.8)	0.3 (0.8)	0.4 (0.8)
Lock Up B in. w.c. (mbar)	0.3 (0.8)	0.4 (0.8)	0.5 (0.8)	0.5 (1.3)

Notes:

*Individual regulator performance may vary from data shown.

A. Change in outlet pressure for 10 PSIG inlet pressure change.

B. Outlet pressure increase required for lock up.

 Do not operate orifice in shaded inlet pressure area.

 Inlet pressure is too low to deliver 14" w.c. (35 mbar).

14" w.c. (35 mbar) Capacity Table (2" Droop) 2" Outlet *continued*

Capacities in SCFH of 0.6 S.G. gas; base conditions of 14.7 PSIA and 60° F.

Inlet Pressure		Orifice size															
PSIG	Bar	1/2"		1/2" x 5/8"		5/8"		5/8" x 3/4"		3/4"		3/4" x 7/8"		7/8"		7/8" x 1"	
16" w.c.	0.040	450	(12.7)	500	(14.2)	600	(17.0)	700	(19.8)	750	(21.2)	900	(25.5)	950	(26.9)	1050	(29.7)
18" w.c.	0.045	600	(17.0)	700	(19.8)	750	(21.2)	850	(24.1)	900	(25.5)	1050	(29.7)	1200	(34.0)	1300	(36.8)
21" w.c.	0.052	750	(21.2)	850	(24.1)	900	(25.5)	1100	(31.1)	1250	(35.4)	1400	(39.6)	1450	(41.1)	1500	(42.5)
24" w.c.	0.060	800	(22.7)	1100	(31.1)	1150	(32.6)	1350	(38.2)	1400	(39.6)	1500	(42.5)	1550	(43.9)	1700	(48.1)
1	0.069	900	(25.5)	1200	(34.0)	1350	(38.2)	1450	(41.1)	1550	(43.9)	1650	(46.7)	1800	(51.0)	2150	(60.9)
2	0.138	1700	(48.1)	1900	(53.8)	2550	(72.2)	2800	(79.3)	3100	(87.8)	3200	(90.6)	4200	(118.9)	4400	(124.6)
3	0.207	2400	(68.0)	3000	(85.0)	3400	(96.3)	3600	(101.9)	3800	(107.6)	3900	(110.4)	4500	(127.4)	5200	(147.2)
5	0.345	2500	(70.8)	4000	(113.3)	4200	(118.9)	5000	(141.6)	5500	(155.7)	6000	(169.9)	6300	(178.4)	6500	(184.1)
10	0.69	4700	(133.1)	6000	(169.9)	7000	(198.2)	7600	(215.2)	8800	(249.2)	9000	(254.9)	9100	(257.7)	10000	(283.2)
20	1.38	8300	(235.0)	8500	(240.7)	10000	(283.2)	10000	(283.2)	10000	(283.2)	10000	(283.2)	10000	(283.2)	10000	(283.2)
30	2.07	10000	(283.2)	10000	(283.2)	10000	(283.2)	10000	(283.2)	10000	(283.2)	10000	(283.2)	10000	(283.2)		
40	2.76	10000	(283.2)	10000	(283.2)	10000	(283.2)	10000	(283.2)	10000	(283.2)	10000	(283.2)	10000	(283.2)		
50	3.45	10000	(283.2)	10000	(283.2)	10000	(283.2)	10000	(283.2)	10000	(283.2)	10000	(283.2)	10000	(283.2)		
60	4.14	10000	(283.2)	10000	(283.2)	10000	(283.2)	10000	(283.2)	10000	(283.2)	10000	(283.2)	10000	(283.2)		
70	4.83	10000	(283.2)	10000	(283.2)												
80	5.52																
90	6.21																
100	6.90																
125	8.63																

Inlet EffectA in. w.c. (mbar)	0.4 (0.8)	0.4 (0.8)	0.5 (1.0)	0.5 (1.3)	0.5 (1.3)	0.5 (1.3)	0.6 (1.5)	0.6 (1.5)
Lock UpB in. w.c. (mbar)	0.5 (1.3)	0.6 (1.5)	1.1 (2.5)	1.1 (2.5)	1.2 (2.8)	1.2 (2.8)	1.2 (2.8)	1.2 (2.8)

Notes:

*Individual regulator performance may vary from data shown.

A. Change in outlet pressure for 10 PSIG inlet pressure change.

B. Outlet pressure increase required for lock up.



Do not operate orifice in shaded inlet pressure area.

B34 PERFORMANCE CURVES

14" w.c. Set Point

Type and model	B34R
Inlet size	2" NPT
Outlet size	2" NPT
Orifice size	1/4" x 3/8"
Spring	Purple

All test results are reported at a base of 14.7 PSIA at 60° F and with 0.6 S.G. gas.

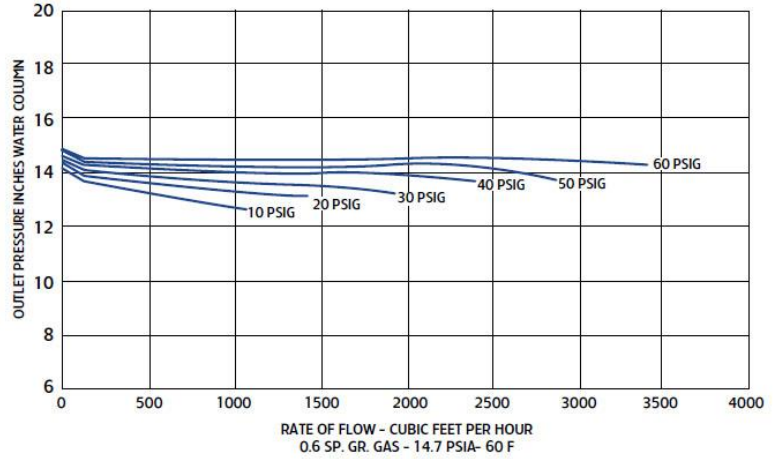

B34 RELIEF CURVES

14" w.c. Set Point

Inlet size	2" NPT
Outlet size	2" NPT
Vent size	1" NPT

All test results are reported at a base of 14.7 PSIA at 60° F and with 0.6 S.G. gas.

Regulator set at 14.0" w.c. with 40 PSIG inlet pressure at 200 SCFH.

B34R Relief Curves, Blocked Open, 14" Set Point

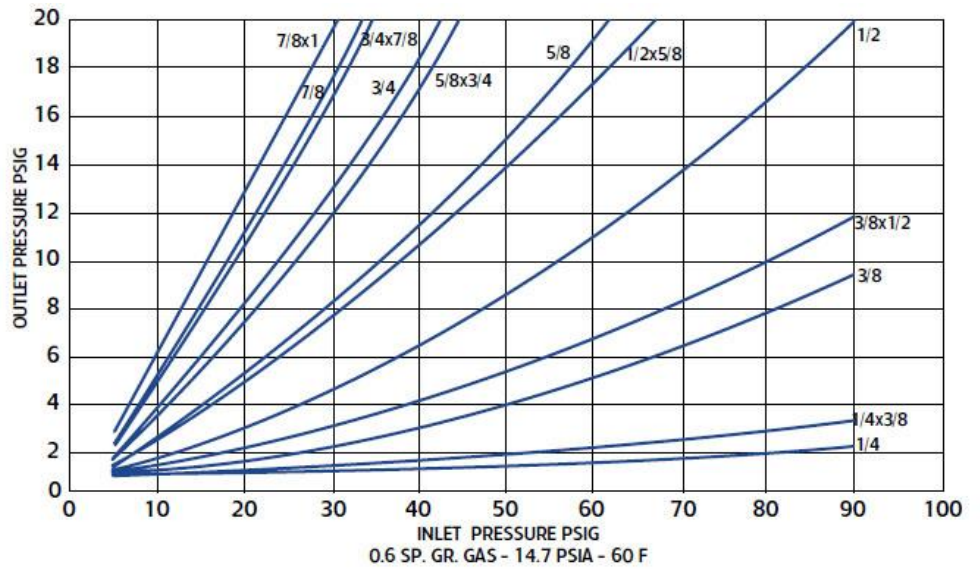

B34R SERIES COMMERCIAL REGULATOR

1 PSIG (69 mbar) Capacity Table (1% Absolute Droop*) 2" Outlet

Capacities in SCFH of 0.6 S.G. gas; base conditions of 14.7 PSIA and 60° F.

Typical Capacity Info.		Inlet Pressure		Orifice Size											
		PSIG	Bar	1/4"		1/4" x 3/8"		3/8"		3/8" x 1/2"		1/2"		1/2" x 5/8"	
Manufacturer	Itron														
Type and model	B34R	2	(0.138)												
Regulator		3	(0.207)	550	(15.6)	575	(16.3)	1250	(35.8)	1300	(36.8)	1400	(39.6)	1500	(42.5)
Inlet size	2" NPT	5	(0.345)	600	(17.0)	1000	(28.3)	1500	(42.5)	1500	(42.5)	1800	(51.0)	2000	(56.6)
Outlet size	2" NPT	10	(0.69)	1000	(28.3)	1500	(42.5)	2000	(56.6)	2800	(79.3)	3000	(85.0)	4300	(121.8)
Position	11	20	(1.38)	1700	(47.6)	2200	(62.3)	4000	(113.3)	4700	(133.1)	6300	(178.4)	8000	(226.5)
Spring color	Silver	30	(2.07)	2400	(68.0)	2800	(79.3)	5600	(158.6)	6400	(181.2)	10000	(283.2)	11000	(311.5)
		40	(2.76)	2800	(79.3)	3600	(101.9)	7000	(198.2)	7800	(220.9)	12500	(354.0)	13000	(368.1)
		50	(3.45)	3700	(104.8)	4200	(118.9)	9000	(254.9)	9000	(254.9)	14000	(396.4)	15500	(438.9)
		60	(4.14)	4000	(113.3)	4700	(133.1)	10000	(283.2)	10000	(283.2)	16000	(453.1)	17000	(481.4)
		70	(4.83)	4800	(135.9)	5200	(147.2)	10800	(305.8)	11800	(334.1)	16500	(467.2)	18000	(509.7)
		80	(5.52)	5150	(145.8)	5500	(155.7)	11400	(322.8)	13000	(368.1)	17000	(481.4)	19000	(538.0)
		90	(6.21)	5300	(150.1)	5600	(158.6)	12300	(348.3)	14000	(396.4)	17500	(495.5)	20000	(566.3)
		100	(6.90)	7000	(198.2)	7300	(206.7)	13500	(382.3)	15000	(424.8)	18000	(509.7)	20000	(566.3)
		125	(8.63)	8400	(237.9)	8700	(246.4)	14200	(402.1)	15800	(447.4)	18900	(535.2)	20000	(566.3)

Inlet Effect A PSIG (mbar)	0.02 (1.38)	0.02 (1.38)	0.02 (1.38)	0.02 (1.38)	0.02 (1.38)	0.02 (1.38)
Lock Up B (mbar)	0.02 (1.38)	0.02 (1.38)	0.02 (1.38)	0.02 (1.38)	0.02 (1.38)	0.02 (1.38)

Notes:

*Individual regulator performance may vary from data shown.

Inlet pressure is too low to deliver 1 PSIG (69 mbar).

1 PSIG (69 mbar) Capacity Table (1% Absolute Droop*) 2" Outlet (continued)

Capacities in SCFH of 0.6 S.G. gas; base conditions of 14.7 PSI and 60° F.

Input Pressure		Orifice Size											
PSIG	Bar	5/8"		5/8" x 3/4"		3/4"		3/4" x 7/8"		7/8"		7/8" x 1"	
2	0.138	1300	(36.8)	1350	(38.2)	1400	(39.6)	1425	(40.4)	1500	(42.5)	2000	(56.6)
3	0.207	1800	(51.0)	1900	(53.8)	2000	(56.6)	2050	(58.0)	2100	(59.5)	2200	(62.3)
5	0.345	2100	(59.5)	2700	(76.5)	2700	(76.5)	3200	(90.6)	3500	(99.1)	4000	(113.3)
10	0.69	4600	(130.3)	5800	(164.2)	6000	(169.9)	7500	(212.4)	8000	(226.5)	8500	(240.7)
20	1.38	8500	(240.7)	11000	(308.0)	11300	(320.9)	12000	(339.8)	12500	(354.0)	14000	(396.4)
30	2.07	12500	(354.0)	16200	(458.7)	16500	(467.2)	17500	(495.5)	18000	(509.7)	19000	(538.0)
40	2.76	14500	(410.6)	17200	(487.0)	17600	(498.4)	18500	(523.9)	20000	(566.3)	20000	(566.3)
50	3.45	16300	(461.6)	18000	(509.7)	18400	(521.0)	19300	(546.5)	20000	(566.3)	20000	(566.3)
60	4.14	17300	(489.9)	18200	(515.4)	18700	(529.5)	20000	(566.3)	20000	(566.3)	20000	(566.3)
70	4.83	18200	(515.4)	19100	(540.9)	19600	(555.0)	20000	(566.3)	20000	(566.3)	20000	(566.3)
80	5.52	19100	(540.9)	20000	(566.3)	20000	(566.3)	20000	(566.3)	20000	(566.3)	20000	(566.3)
90	6.21	20000	(566.3)	20000	(566.3)	20000	(566.3)	20000	(566.3)	20000	(566.3)	20000	(566.3)
100	6.90	20000	(566.3)	20000	(566.3)	20000	(566.3)	20000	(566.3)	20000	(566.3)	20000	(566.3)
125	8.63	20000	(566.3)	20000	(566.3)	20000	(566.3)	20000	(566.3)	20000	(566.3)	20000	(566.3)

In Effect ^A PSIG (mbar)	0.03 (2.07)	0.03 (2.07)	0.03 (2.07)	0.04 (2.76)	0.04 (2.76)	0.04 (2.76)
Lock Up ^B PSIG (mbar)	0.03 (2.07)	0.03 (2.07)	0.03 (2.07)	0.04 (2.76)	0.04 (2.76)	0.05 (3.45)

Notes:

*Individual regulator performance may vary from data shown.

B34R SERIES COMMERCIAL REGULATOR

1 PSIG (69 mbar) Capacity Table (2% Absolute Droop*) 2" Outlet

Capacities in SCFH of 0.6 S.G. gas; base conditions of 14.7 PSIA and 60° F.

Typical Capacity Info.

Manufacturer	Itron
Type and model	B34R
Regulator	
Inlet size	2" NPT
Outlet size	2" NPT
Position	11
Spring color	Silver

Inlet Pressure		Orifice Size											
PSIG	Bar	1/4"		1/4" x 3/8"		3/8"		3/8" x 1/2"		1/2"		1/2" x 5/8"	
2	(0.138)												
3	(0.207)	700	(19.8)	750	(21.2)	1500	(42.5)	1600	(45.3)	2300	(65.1)	2400	(68.0)
5	(0.345)	800	(22.4)	1000	(28.3)	1900	(53.8)	2000	(56.6)	3400	(96.3)	3700	(104.8)
10	(0.69)	1500	(42.5)	1500	(42.5)	3000	(85.0)	3200	(90.6)	5000	(141.6)	6000	(169.9)
20	(1.38)	1650	(46.7)	2200	(62.3)	4500	(127.4)	4800	(135.9)	8500	(240.7)	9000	(254.9)
30	(2.07)	2700	(76.5)	2900	(82.1)	6300	(178.4)	6500	(184.1)	11000	(311.5)	11500	(325.6)
40	(2.76)	3340	(94.6)	3500	(99.1)	7400	(209.5)	7600	(215.2)	13000	(368.1)	13500	(382.3)
50	(3.45)	3950	(111.9)	4100	(116.1)	8500	(240.7)	9000	(254.9)	15500	(438.9)	16000	(453.1)
60	(4.14)	4700	(133.1)	4700	(133.1)	10500	(297.3)	10800	(305.8)	16500	(467.2)	17000	(481.4)
70	(4.83)	4750	(134.5)	5000	(141.6)	11000	(311.5)	11600	(328.5)	17500	(495.5)	18000	(509.7)
80	(5.52)	4950	(140.2)	5400	(152.9)	12000	(339.8)	13000	(368.1)	18000	(509.7)	19000	(538.0)
90	(6.21)	5500	(155.7)	6500	(184.1)	12500	(354.0)	13500	(382.3)	19000	(538.0)	20000	(566.3)
100	(6.90)	7000	(198.2)	7250	(205.3)	13250	(375.2)	14000	(396.4)	20000	(566.3)	20000	(566.3)
125	(8.63)	8500	(240.7)	9000	(254.9)	13900	(393.6)	14700	(416.3)	20000	(566.3)	20000	(566.3)

Inlet Effect ^A PSIG (mbar)	0.02 (1.38)	0.02 (1.38)	0.02 (1.38)	0.02 (1.38)	0.02 (1.38)	0.02 (1.38)
Lock Up ^B PSIG (mbar)	0.02 (1.38)	0.02 (1.38)	0.02 (1.38)	0.02 (1.38)	0.02 (1.38)	0.02 (1.38)

Notes:

*Individual regulator performance may vary from data shown.

A. Change in outlet pressure for 10 PSIG inlet pressure change.

B. Outlet pressure increase required for lock up.

Inlet pressure is too low to deliver 1 PSIG (69 mbar).

1 PSIG (69 mbar) Capacity Table (2% Absolute Droop*) 2" Outlet (continued)

Capacities in SCFH of 0.6 S.G. gas; base conditions of 14.7 PSIA and 60° F.

Inlet Pressure		5/8"		5/8" x 3/4"		3/4"		3/4" x 7/8"		7/8"		7/8" x 1"	
PSIG	Bar	2200	(63.2)	2300	(65.1)	2400	(68.0)	2500	(70.8)	2700	(76.5)	4200	(118.9)
2	0.138	2800	(79.3)	3000	(85.0)	3400	(96.3)	3800	(107.6)	4000	(113.3)	6000	(170.9)
3	0.207	4000	(113.3)	5000	(141.6)	5200	(147.2)	6000	(169.9)	7000	(198.2)	7500	(212.4)
5	0.345	7000	(198.2)	8900	(252.0)	9000	(254.9)	10000	(283.2)	11500	(325.6)	13000	(368.1)
10	0.69	10000	(283.2)	12000	(339.8)	13000	(368.1)	15000	(424.8)	15500	(438.9)	19000	(538.0)
20	1.38	13000	(368.1)	16000	(445.1)	18000	(509.7)	19000	(538.0)	20000	(566.3)	20000	(566.3)
30	2.07	16000	(453.1)	16500	(467.2)	19000	(538.0)	19500	(552.2)	20000	(566.3)	20000	(566.3)
40	2.76	19000	(538.0)	20000	(566.3)	20000	(566.3)	20000	(566.3)	20000	(566.3)	20000	(566.3)
50	3.45	20000	(566.3)	20000	(566.3)	20000	(566.3)	20000	(566.3)	20000	(566.3)	20000	(566.3)
60	4.14	20000	(566.3)	20000	(566.3)	20000	(566.3)	20000	(566.3)	20000	(566.3)	20000	(566.3)
70	4.83	20000	(566.3)	20000	(566.3)	20000	(566.3)	20000	(566.3)	20000	(566.3)	20000	(566.3)
80	5.52	20000	(566.3)	20000	(566.3)	20000	(566.3)	20000	(566.3)	20000	(566.3)	20000	(566.3)
90	6.21	20000	(566.3)	20000	(566.3)	20000	(566.3)	20000	(566.3)	20000	(566.3)	20000	(566.3)
100	6.90	20000	(566.3)	20000	(566.3)	20000	(566.3)	20000	(566.3)	20000	(566.3)	20000	(566.3)
125	8.63	20000	(566.3)	20000	(566.3)	20000	(566.3)	20000	(566.3)	20000	(566.3)	20000	(566.3)

Inlet EffectA PSIG (mbar)	0.03 (2.07)	0.03 (2.07)	0.03 (2.07)	0.04 (2.76)	0.04 (2.76)	0.04 (2.76)
Lock UpB PSIG (mbar)	0.03 (2.07)	0.03 (2.07)	0.03 (2.07)	0.04 (2.76)	0.04 (2.76)	0.05 (3.45)

Notes:

*Individual regulator performance may vary from data shown.

B34 PERFORMANCE CURVES

1 PSIG Set Point

Type and model	B34R
Inlet size	2" NPT
Outlet size	2" NPT
Orifice size	1/4" x 3/8"
Spring	Silver

All test results are reported at a base of 14.7 PSIA at 60°F and with 0.6 S.G. gas.

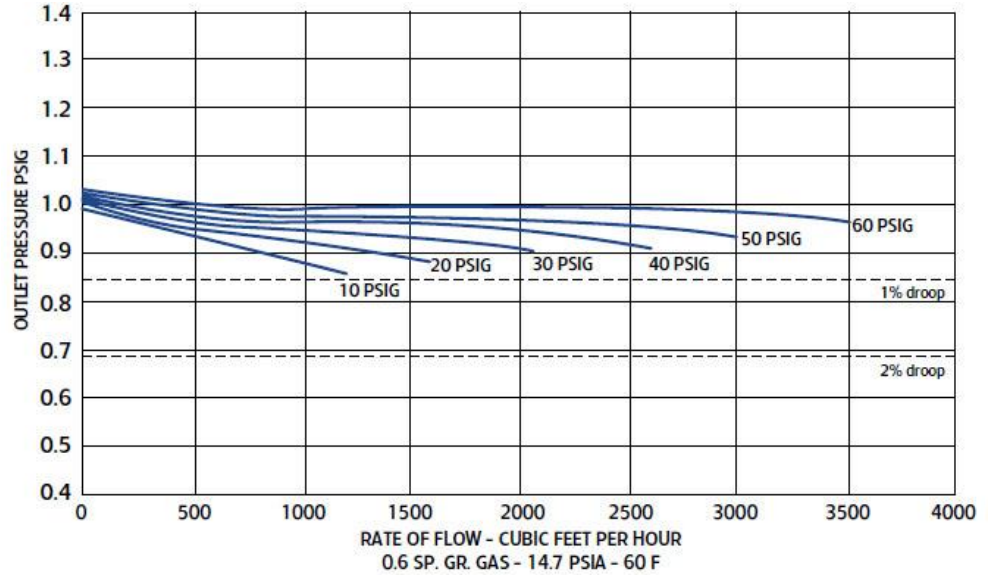

RELIEF CURVES

1 PSIG Set Point

Inlet size	2" NPT
Outlet size	2" NPT
Vent size	1" NPT

All test results are reported at a base of 14.7 PSIA at 60° F and with 0.6 S.G. gas.

Regulator set at 1.0 PSIG with 40 PSIG inlet pressure at 200 SCFH.

B34R Relief Curves, Blocked Open, 1 PSIG Set Point

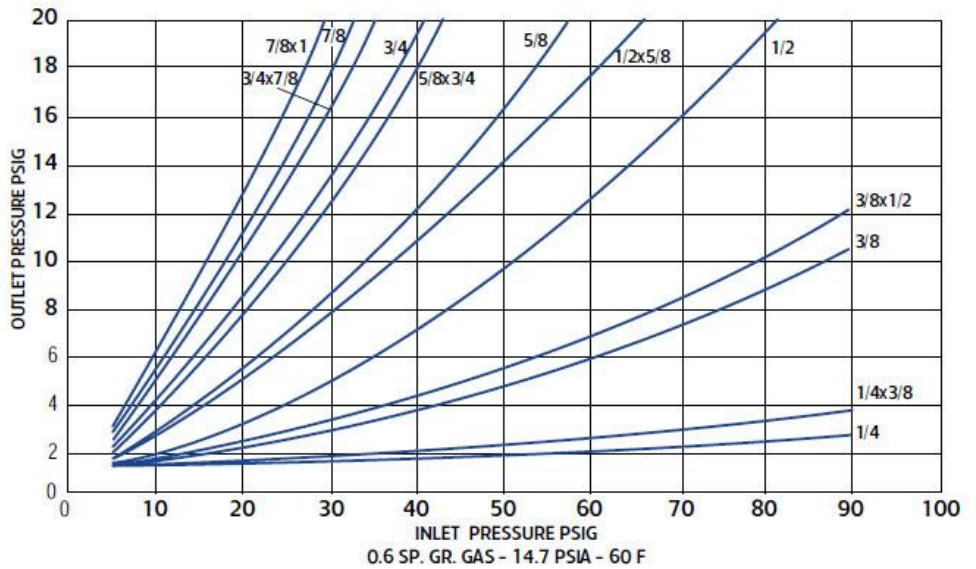

B34R SERIES COMMERCIAL REGULATOR

2 PSIG (69 mbar) Capacity Table (1% Absolute Droop*) 2" Outlet

Capacities in SCFH of 0.6 S.G. gas; base conditions of 14.7 PSIA and 60° F.

Typical Capacity Info.

Manufacturer	Itron
Type and model	B34R
Regulator	
Inlet size	2" NPT
Outlet size	2" NPT
Position	11
Spring color	Silver

Inlet Pressure		Orifice Size											
PSIG	Bar	1/4"		1/4" x 3/8"		3/8"		3/8" x 1/2"		1/2"		1/2" x 5/8"	
3	0.207												
5	0.345	500	(14.2)	900	(25.5)	1000	(28.3)	1500	(42.5)	1700	(48.1)	1900	(53.8)
10	0.69	1000	(28.3)	1700	(48.1)	1800	(51.0)	2500	(70.8)	2700	(76.5)	3000	(85.0)
20	1.38	1050	(29.7)	2200	(62.3)	2300	(65.1)	4700	(133.1)	5200	(147.2)	5400	(152.9)
30	2.07	2200	(62.3)	2800	(79.3)	3700	(104.8)	6500	(184.1)	7000	(198.2)	9500	(269.0)
40	2.76	2700	(76.5)	3500	(99.1)	6000	(169.9)	7500	(212.4)	10800	(305.8)	12500	(354.0)
50	3.45	3500	(99.1)	4100	(116.1)	7600	(215.2)	8800	(249.2)	13300	(376.6)	14500	(410.6)
60	4.14	4000	(113.3)	4700	(133.1)	9500	(269.0)	10000	(283.2)	14000	(396.4)	16000	(453.1)
70	4.83	4400	(124.6)	5000	(141.6)	10900	(308.7)	11300	(320.0)	16000	(453.1)	16500	(467.2)
80	5.52	4800	(135.9)	5400	(152.9)	12500	(354.0)	13000	(368.1)	20000	(566.3)	20000	(566.3)
90	6.21	5500	(155.7)	5600	(158.6)	12300	(348.3)	13500	(382.3)	20000	(566.3)	20000	(566.3)
100	6.90	6400	(181.2)	7000	(198.2)	12800	(362.5)	14800	(419.1)	20000	(566.3)	20000	(566.3)
125	8.63	7000	(198.2)	7400	(209.5)	13400	(379.4)	15500	(438.9)	20000	(566.3)	20000	(566.3)

Inlet Effect A PSIG (mbar)	0.02 (1.38)	0.02 (1.38)	0.02 (1.38)	0.02 (1.38)	0.03 (2.07)	0.03 (2.07)
Lock Up B PSIG (mbar)	0.03 (2.07)	0.03 (2.07)	0.03 (2.07)	0.03 (2.07)	0.03 (2.07)	0.03 (2.07)

Notes:

*Individual regulator performance may vary from data shown.

A. Change in outlet pressure for 10 PSIG inlet pressure change.

B. Outlet pressure increase required for lock up.

Inlet pressure is too low to deliver 2 PSIG (138 mbar).

2 PSIG (69 mbar) Capacity Table (1% Absolute Droop*) 2" Outlet *continued*

Capacities in SCFH of 0.6 S.G. gas; base conditions of 14.7 PSIA and 60° F.

Inlet Pressure		Orifice Size											
PSIG	Bar	5/8"		5/8" x 3/4"		3/4"		3/4" x 7/8"		7/8"		7/8" x 1"	
3	0.207			1300	(36.8)	1500	(42.5)	1600	(45.3)	1700	(48.1)	2000	(56.6)
5	0.345	2000	(56.6)	2250	(63.7)	2500	(70.8)	3000	(85.0)	3000	(85.0)	3200	(90.6)
10	0.69	3200	(90.6)	4800	(135.9)	5000	(141.6)	6500	(184.1)	6800	(192.6)	7500	(212.4)
20	1.38	5500	(155.7)	8500	(240.7)	9000	(254.9)	9000	(254.9)	10600	(300.2)	11200	(317.1)
30	2.07	10000	(283.2)	13000	(368.1)	14500	(410.6)	16000	(453.1)	17000	(481.4)	17400	(492.7)
40	2.76	13000	(368.1)	16500	(467.2)	17900	(506.9)	18300	(518.2)	18900	(535.2)	20600	(566.3)
50	3.45	15000	(424.8)	19000	(538.0)	20000	(566.3)	20000	(566.3)	20000	(566.3)	20000	(566.3)
60	4.14	17000	(481.4)	19500	(552.2)	20000	(566.3)	20000	(566.3)	20000	(566.3)	20000	(566.3)
70	4.83	17900	(506.9)	20000	(566.3)	20000	(566.3)	20000	(566.3)	20000	(566.3)	20000	(566.3)
80	5.52	18800	(532.4)	20000	(566.3)	20000	(566.3)	20000	(566.3)	20000	(566.3)	20000	(566.3)
90	6.21	19700	(557.8)	20000	(566.3)	20000	(566.3)	20000	(566.3)	20000	(566.3)	20000	(566.3)
100	6.90	20000	(566.3)	20000	(566.3)	20000	(566.3)	20000	(566.3)	20000	(566.3)	20000	(566.3)
125	8.63	20000	(566.3)	20000	(566.3)	20000	(566.3)	20000	(566.3)	20000	(566.3)	20000	(566.3)

Inlet Effect ^A PSIG (mbar)	0.03 (2.07)	0.03 (2.07)	0.03 (2.07)	0.03 (2.07)	0.03 (2.07)	0.03 (2.07)
Lock Up ^B PSIG (mbar)	0.04 (2.76)	0.04 (2.76)	0.04 (2.76)	0.06 (4.14)	0.07 (4.83)	0.07 (4.83)

Notes:

*Individual regulator performance may vary from data shown.

A. Change in outlet pressure for 10 PSIG inlet pressure change.

B. Outlet pressure increase required for lock up.

Inlet pressure is too low to deliver 2 PSIG (138 mbar).

B34R SERIES COMMERCIAL REGULATOR

2 PSIG (69 mbar) Capacity Table (2% Absolute Droop*) 2" Outlet

Capacities in SCFH of 0.6 S.G. gas; base conditions of 14.7 PSIA and 60° F.

Typical Capacity Info.		Inlet Pressure		Orifice Size											
		PSIG	Bar	1/4"		1/4" x 3/8"		3/8"		3/8" x 1/2"		1/2"		1/2" x 5/8"	
Manufacturer	Itron	3	(0.207)												
Type and model	B34R	5	(0.345)	700	(19.8)	900	(25.5)	1800	(51.0)	2000	(56.6)	2800	(79.3)	3100	(87.8)
Regulator		10	(0.69)	1300	(36.8)	1500	(42.5)	2800	(79.3)	3000	(85.0)	4500	(127.0)	5800	(164.2)
Inlet size	2" NPT	20	(1.38)	1650	(46.7)	2200	(62.3)	4500	(127.4)	4800	(135.9)	8500	(240.7)	9000	(254.9)
Outlet size	2" NPT	30	(2.07)	2700	(76.5)	2900	(82.1)	6300	(178.4)	6500	(184.1)	11000	(311.5)	11500	(325.6)
Spring color	Silver	40	(2.76)	3340	(94.6)	3500	(99.1)	7450	(211.0)	7600	(215.2)	13200	(373.8)	13500	(382.3)
Position	11	50	(3.45)	3950	(111.9)	4100	(116.1)	8700	(246.4)	9000	(254.9)	15500	(438.9)	16000	(453.1)
		60	(4.14)	4500	(127.4)	4700	(133.1)	10200	(288.8)	10500	(297.3)	17000	(481.4)	17000	(481.4)
		70	(4.83)	4740	(134.2)	5000	(141.6)	10900	(308.7)	11600	(328.5)	19000	(532.0)	20000	(566.3)
		80	(5.52)	4950	(140.2)	5400	(152.9)	12500	(354.0)	13000	(368.1)	20000	(566.3)	20000	(566.3)
		90	(6.21)	5800	(164.2)	6000	(170.0)	13000	(368.1)	14000	(396.4)	20000	(566.3)	20000	(566.3)
		100	(6.90)	6900	(195.4)	7500	(212.4)	13500	(382.3)	15500	(438.9)	20000	(566.3)	20000	(566.3)
		125	(8.63)	8300	(235.0)	8800	(249.2)	14200	(402.1)	16300	(461.6)	20000	(566.3)	20000	(566.3)

Inlet Effect ^A PSIG (mbar)	0.02 (1.38)	0.02 (1.38)	0.02 (1.38)	0.02 (1.38)	0.03 (2.07)	0.03 (2.07)
Lock Up ^B PSIG (mbar)	0.03 (2.07)	0.03 (2.07)	0.03 (2.07)	0.03 (2.07)	0.03 (2.07)	0.03 (2.07)

Notes:

*Individual regulator performance may vary from data shown.

A. Change in outlet pressure for 10 PSIG inlet pressure change.

B. Outlet pressure increase required for lock up.

Inlet pressure is too low to deliver 2 PSIG (138 mbar).

2 PSIG (69 mbar) Capacity Table (2% Absolute Droop*) 2" Outlet (continued)

Capacities in SCFH of 0.6 S.G. gas; base conditions of 14.7 PSIA and 60° F.

Input Pressure		Orifice Size											
PSIG	Bar	5/8"		5/8" x 3/4"		3/4"		3/4" x 7/8"		7/8"		7/8" x 1"	
3	0.207			2500	(70.8)	2800	(79.3)	3500	(99.1)	3700	(104.8)	4000	(113.3)
5	0.345	3200	(90.6)	3600	(101.9)	4100	(116.1)	5000	(141.6)	5000	(141.6)	6000	(169.9)
10	0.69	6000	(169.9)	7000	(198.2)	7500	(212.4)	9500	(269.0)	9800	(277.5)	12000	(339.8)
20	1.38	10000	(283.2)	12000	(339.8)	13000	(368.1)	14000	(396.4)	15500	(438.9)	19000	(538.0)
30	2.07	13000	(368.1)	16000	(453.1)	18500	(523.9)	19500	(552.2)	20000	(566.3)	20000	(566.3)
40	2.76	16000	(448.0)	19000	(538.0)	20000	(566.3)	20000	(588.0)	20000	(566.3)	20000	(566.3)
50	3.45	20000	(566.3)	20000	(566.3)	20000	(566.3)	20000	(566.3)	20000	(566.3)	20000	(566.3)
60	4.14	20000	(566.3)	20000	(566.3)	20000	(566.3)	20000	(566.3)	20000	(566.3)	20000	(566.3)
70	4.83	20000	(566.3)	20000	(566.3)	20000	(566.3)	20000	(566.3)	20000	(566.3)	20000	(566.3)
80	5.52	20000	(566.3)	20000	(566.3)	20000	(566.3)	20000	(566.3)	20000	(566.3)	20000	(566.3)
90	6.21	20000	(566.3)	20000	(566.3)	20000	(566.3)	20000	(566.3)	20000	(566.3)	20000	(566.3)
100	6.90	20000	(566.3)	20000	(566.3)	20000	(566.3)	20000	(566.3)	20000	(566.3)	20000	(566.3)
125	8.63	20000	(566.3)	20000	(566.3)	20000	(566.3)	20000	(566.3)	20000	(566.3)	20000	(566.3)

Inlet Effect ^A PSIG (mbar)	0.03 (2.07)	0.03 (2.07)	0.03 (2.07)	0.03 (2.07)	0.03 (2.07)	0.03 (2.07)
Lock Up ^B PSIG (mbar)	0.04 (2.76)	0.04 (2.76)	0.04 (2.76)	0.06 (4.14)	0.07 (4.83)	0.07 (4.83)

Notes:

*Individual regulator performance may vary from data shown.

A. Change in outlet pressure for 10 PSIG inlet pressure change.

B. Outlet pressure increase required for lock up.

Inlet pressure is too low to deliver 2 PSIG (138 mbar).

B34 PERFORMANCE CURVES

2 PSIG Set Point

Type and model	B34R
Inlet size	2" NPT
Outlet size	2" NPT
Orifice size	1/4" x 3/8"
Spring	Silver

All test results are reported at a base of 14.7 PSIA at 60°F and with 0.6 S.G. gas.

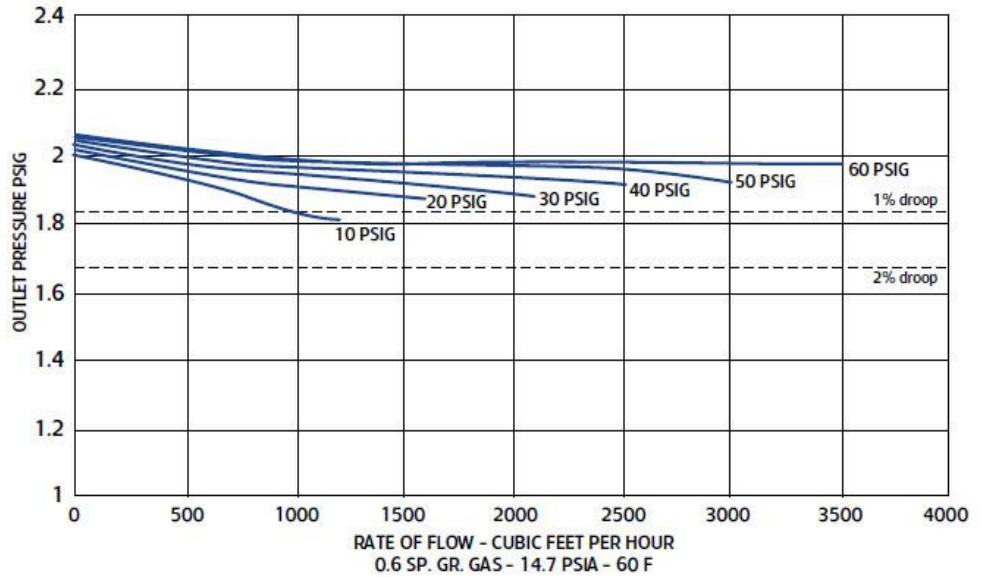

B34 RELIEF CURVES

2 PSIG Set Point

Inlet size	2" NPT
Outlet size	2" NPT
Vent size	1" NPT

All test results are reported at a base of 14.7 PSIA at 60° F and with 0.6 S.G. gas.

Regulator set at 1.0 PSIG with 40 PSIG inlet pressure at 200 SCFH.

B34R Relief Curves, Blocked Open, 2 PSIG Set Point

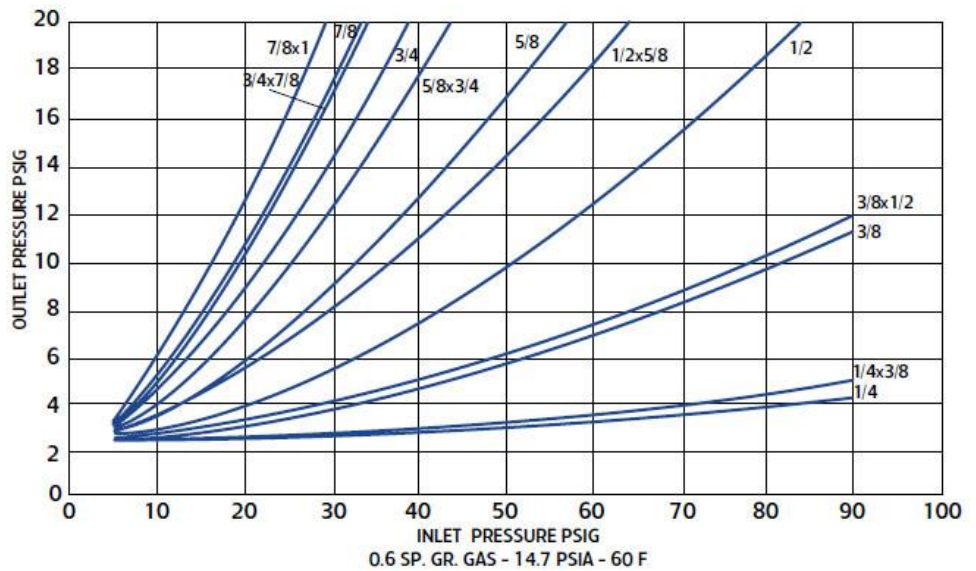

B34R SERIES COMMERCIAL REGULATOR

5 PSIG (345 mbar) Capacity Table (1% Absolute Droop*) 2" Outlet

Capacities in SCFH of 0.6 S.G. gas; base conditions of 14.7 PSIA and 60° F.

Typical Capacity Info.

Manufacturer Itron

Type and model B34R

Regulator

Inlet size 2" NPT

Outlet size 2" NPT

Spring color Red Nested Spring

Position 11

Inlet Pressure		Orifice Size											
PSIG	Bar	1/4"		1/4" x 3/8"		3/8"		3/8" x 1/2"		1/2"		1/2" x 5/8"	
10	(0.69)	500	(14.2)	700	(19.8)	800	(22.7)	900	(25.5)	900	(25.5)	1000	(28.3)
20	(1.38)	800	(22.7)	1100	(31.1)	1100	(31.1)	1300	(36.8)	1500	(42.5)	1900	(53.8)
30	(2.07)	1100	(31.1)	1300	(36.8)	1400	(39.6)	1500	(42.5)	1700	(48.1)	2000	(56.6)
40	(2.76)	1200	(34.0)	1400	(39.6)	1500	(42.5)	1700	(48.1)	2000	(56.6)	2700	(76.5)
50	(3.45)	1300	(36.8)	1500	(42.5)	1700	(48.1)	2000	(56.6)	2500	(70.8)	3500	(99.1)
60	(4.14)	1400	(39.6)	1700	(48.1)	1800	(51.0)	3200	(90.6)	3500	(99.1)	4400	(124.6)
70	(4.83)	1500	(42.5)	1800	(51.0)	1900	(53.8)	3350	(94.9)	3600	(101.9)	4800	(135.9)
80	(5.52)	1600	(45.3)	1900	(53.8)	2000	(56.6)	4200	(118.9)	4500	(127.4)	5100	(152.9)
90	(6.21)	2000	(56.6)	2800	(79.3)	3000	(85.0)	4400	(124.6)	4800	(135.9)	6500	(184.1)
100	(6.90)	2600	(73.6)	3200	(90.6)	3700	(104.8)	4550	(128.8)	5100	(144.4)	7300	(206.7)
125	(8.63)	3200	(90.6)	3400	(96.3)	3900	(110.4)	4800	(135.9)	5400	(152.9)	7700	(218.0)

Inlet Effect ^A PSIG (mbar)	0.02 (1.38)	0.02 (1.38)	0.02 (1.38)	0.02 (1.38)	0.03 (2.07)	0.03 (2.07)
Lock Up ^B PSIG (mbar)	0.05 (0.8)	0.05 (0.8)	0.07 (4.83)	0.07 (4.83)	0.07 (4.83)	0.07 (4.83)

Notes:

*Individual regulator performance may vary from data shown.

A. Change in outlet pressure for 10 PSIG inlet pressure change.

B. Outlet pressure increase required for lock up.

5 PSIG (345 mbar) Capacity Table (1% Absolute Droop*) 2" Outlet (continued)

Capacities in SCFH of 0.6 S.G. gas; base conditions of 14.7 PSIA and 60° F.

Inlet Pressure		Orifice Size											
PSIG	Bar	5/8"		5/8" x 3/4"		3/4"		3/4" x 7/8"		7/8"		7/8" x 1"	
10	0.69	1100	(31.1)	1200	(34.0)	1300	(36.8)	1350	(38.2)	1400	(39.6)	1500	(42.5)
20	1.38	1950	(55.2)	2000	(56.6)	2200	(62.3)	2300	(65.1)	2500	(70.8)	2700	(76.5)
30	2.07	2300	(65.1)	2600	(73.6)	2700	(76.5)	3000	(85.0)	3500	(99.0)	3800	(107.6)
40	2.76	2800	(79.3)	3200	(90.6)	3300	(93.4)	3700	(104.8)	4500	(127.4)	4750	(134.5)
50	3.45	3600	(101.9)	3800	(107.6)	4200	(118.9)	4300	(121.8)	5500	(155.8)	6250	(177.0)
60	4.14	4700	(133.1)	6000	(169.0)	8000	(226.5)	8500	(240.7)	10000	(283.2)	11500	(325.6)
70	4.83	4900	(138.8)	6300	(178.4)	8400	(237.9)	8900	(252.0)	10500	(297.3)	12100	(342.6)
80	5.52	5100	(144.4)	6600	(186.9)	8800	(249.2)	9300	(263.3)	11000	(311.5)	12700	(259.6)
90	6.21	5400	(152.9)	6900	(195.4)	9300	(263.3)	9800	(277.5)	11600	(328.5)	13300	(376.6)
100	6.90	5700	(161.4)	7200	(203.9)	9800	(277.5)	10300	(291.7)	12200	(345.5)	14400	(407.8)
125	8.63	6100	(172.7)	7600	(215.2)	10300	(291.7)	10800	(305.8)	12800	(362.5)	15100	(427.6)

Inlet Effect ^A PSIG (mbar)	0.03 (2.07)	0.03 (2.07)	0.03 (2.07)	0.03 (2.07)	0.03 (2.07)	0.03 (2.07)
Lock Up ^B PSIG (mbar)	0.07 (4.83)	0.07 (4.83)	0.07 (4.83)	0.07 (4.83)	0.08 (5.52)	0.09 (6.21)

Notes:

*Individual regulator performance may vary from data shown.

A. Change in outlet pressure for 10 PSIG inlet pressure change.

B. Outlet pressure increase required for lock up.

B34R SERIES COMMERCIAL REGULATOR

5 PSIG (345 mbar) Capacity Table (2% Absolute Droop*) 2" Outlet

Capacities in SCFH of 0.6 S.G. gas; base conditions of 14.7 PSIA and 60° F.

Typical Capacity Info.		Inlet Pressure		Orifice Size											
		PSIG	Bar	1/4"		1/4" x 3/8"		3/8"		3/8" x 1/2"		1/2"		1/2" x 5/8"	
Manufacturer	Itron														
Type and model	B34R	10	0.69	800	(22.7)	950	(26.9)	1000	(28.3)	1200	(34.0)	1300	(36.8)	1550	(43.9)
Regulator		20	1.38	1100	(31.1)	1600	(45.3)	1700	(48.1)	2300	(65.1)	2750	(77.9)	2850	(80.7)
Inlet size	2" NPT	30	2.07	1500	(42.5)	2100	(59.5)	2200	(62.3)	2800	(79.3)	3300	(93.4)	3500	(99.1)
Outlet size	2" NPT	40	2.76	2000	(56.6)	2400	(68.0)	2700	(76.5)	3900	(110.4)	4300	(121.8)	5000	(141.6)
Spring color	Red Nested	50	3.45	2500	(70.8)	3250	(92.0)	3400	(96.3)	4800	(135.9)	5700	(161.4)	7000	(198.2)
Position	11	60	4.14	2800	(79.3)	4000	(113.3)	4500	(127.4)	5500	(155.7)	6500	(184.1)	7500	(212.4)
		70	4.83	2900	(82.1)	4200	(118.9)	4600	(130.3)	5700	(161.4)	7300	(206.7)	8600	(243.5)
		80	5.52	3100	(87.8)	4500	(127.4)	4800	(135.9)	8200	(232.2)	8600	(243.5)	9500	(269.0)
		90	6.21	3600	(101.9)	5300	(150.1)	5700	(161.4)	9000	(254.9)	10000	(283.2)	15000	(424.8)
		100	6.90	4100	(116.1)	6000	(169.9)	6500	(184.1)	10200	(288.8)	11000	(311.5)	15900	(450.2)
		125	8.63	4900	(138.8)	6800	(192.6)	6800	(192.6)	10700	(303.0)	11600	(328.5)	16700	(472.9)

Inlet Effect ^A PSIG (mbar)	0.02 (1.38)	0.02 (1.38)	0.02 (1.38)	0.02 (1.38)	0.03 (2.07)	0.03 (2.07)
Lock Up ^B PSIG (mbar)	0.05 (0.8)	0.05 (0.8)	0.07 (4.83)	0.07 (4.83)	0.07 (4.83)	0.07 (4.83)

Notes:

*Individual regulator performance may vary from data shown.

A. Change in outlet pressure for 10 PSIG inlet pressure change.

B. Outlet pressure increase required for lock up.

5 PSIG (345 mbar) Capacity Table (2% Absolute Droop*) 2" Outlet (continued)

Capacities in SCFH of 0.6 S.G. gas; base conditions of 14.7 PSIA and 60° F.

Inlet Pressure		Orifice Size											
PSIG	Bar	5/8"		5/8" x 3/4"		3/4"		3/4" x 7/8"		7/8"		7/8" x 1"	
10	0.69	1600	(45.3)	2000	(56.6)	2200	(62.3)	2300	(65.1)	2450	(69.4)	2500	(70.8)
20	1.38	3000	(85.0)	3500	(99.1)	3800	(107.6)	4000	(113.3)	4300	(121.8)	4500	(127.4)
30	2.07	4100	(116.1)	4400	(124.6)	4500	(127.4)	5700	(161.4)	6800	(192.6)	7200	(203.9)
40	2.76	5300	(150.1)	6400	(181.2)	7000	(198.2)	7500	(212.4)	8000	(226.5)	10500	(297.3)
50	3.45	7200	(203.9)	7500	(212.4)	8300	(235.0)	9500	(269.0)	10600	(300.2)	11500	(325.6)
60	4.14	8800	(249.2)	13300	(376.6)	15000	(424.8)	15800	(447.4)	16500	(467.2)	17000	(481.4)
70	4.83	9200	(260.5)	14000	(396.4)	15800	(447.4)	16600	(470.1)	17300	(489.9)	17900	(506.9)
80	5.52	9700	(274.7)	14700	(416.3)	16600	(470.1)	17400	(492.7)	18200	(515.4)	18800	(532.4)
90	6.21	10200	(288.8)	15400	(436.1)	17400	(492.7)	18300	(518.2)	19100	(540.9)	19700	(557.8)
100	6.90	10700	(303.0)	16200	(458.7)	18300	(518.2)	19200	(543.7)	20000	(566.3)	20000	(566.3)
125	8.63	11200	(317.1)	17000	(481.4)	19200	(543.7)	20000	(566.3)	20000	(566.3)	20000	(566.3)

Inlet Effect ^A PSIG (mbar)	0.03 (2.07)	0.03 (2.07)	0.03 (2.07)	0.03 (2.07)	0.03 (2.07)	0.03 (2.07)
Lock Up ^B PSIG (mbar)	0.07 (4.83)	0.07 (4.83)	0.07 (4.83)	0.07 (4.83)	0.08 (5.52)	0.09 (6.21)

Notes:

*Individual regulator performance may vary from data shown.

A. Change in outlet pressure for 10 PSIG inlet pressure change.

B. Outlet pressure increase required for lock up.

B34 PERFORMANCE CURVES

5 PSIG Set Point

Type and model	B34R
Inlet size	2" NPT
Outlet size	2" NPT
Orifice size	1/4" x 3/8"
Spring	Red-Nested

All test results are reported at a base of 14.7 PSIA at 60° F and with 0.6 S.G. gas.

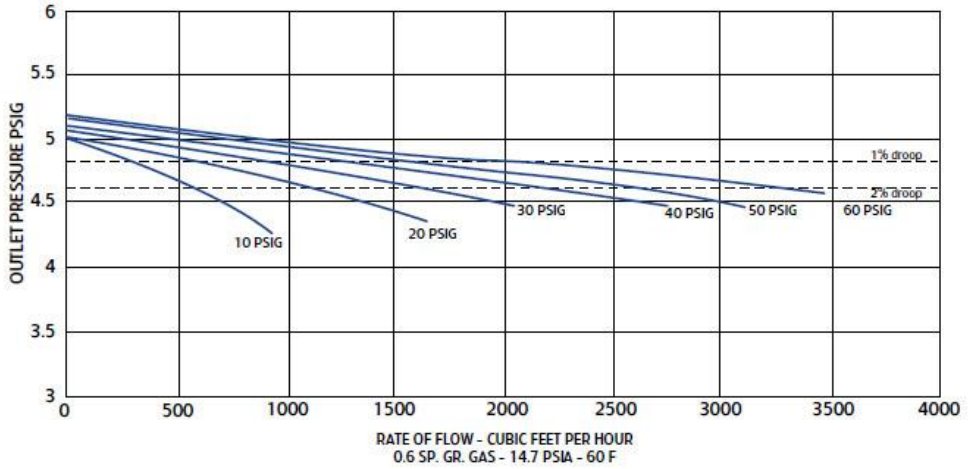

RELIEF CURVES

5 PSIG Set Point

Inlet size	2" NPT
Outlet size	2" NPT
Vent size	1" NPT

All test results are reported at a base of 14.7 PSIA at 60° F and with 0.6 S.G. gas.

B34R Relief Curves, Blocked Open, 5 PSIG Set Point

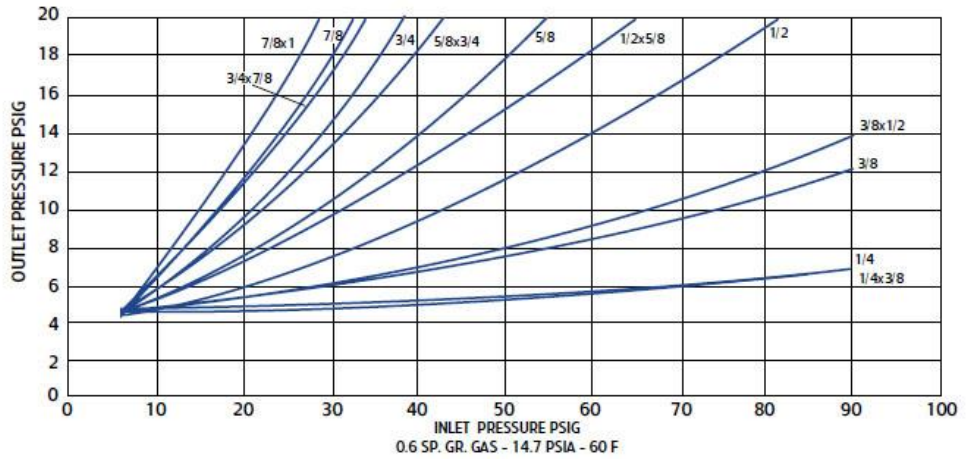

B34 IM INTERNAL MONITOR * SERVICE REGULATOR

General Description

The B-34-IM regulator is designed specifically to comply with BOT OPS 192.197 paragraph B which states, "or if the gas contains materials that seriously interfere with the operation of a service regulator, there must be suitable protective devices to prevent unsafe over-pressuring of the customer's appliance, if the service regulator fails." The code lists the devices; one of the devices is a regulator and monitor. The code further states the monitor may be installed as an internal part of the service regulator or as a separate unit. The IM internal monitor is designed as a single valve body regulator with built-in monitor operation. It features the safety advantage of a second gas tight lock-up seat if the normal orifice face and valve seat fail to produce bubble tight lock up. The monitor also controls gas flow between the failed open flow and no flow, providing complete secondary regulation and monitor regulation function without relieving gas to the atmosphere or shutting off the gas flow to the customer. The monitor overpressure takeover is a 4" w.c. increase on regulators set for 6 to 9" w.c., a 0.5 PSIG increase for regulators set for 2 PSIG, and a 1 PSIG increase for regulators set for 5 PSIG.

*Patent Numbers 3,613,725 and 3,754,570.

PRINCIPLE OF OPERATION

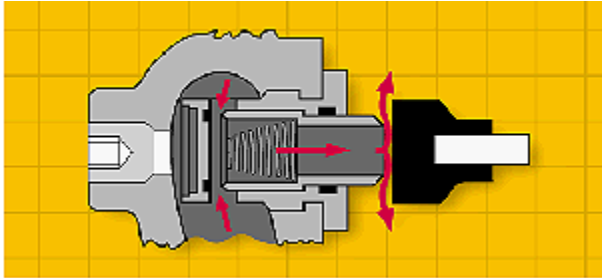

A. Standard regulator and upstream monitor orifice.

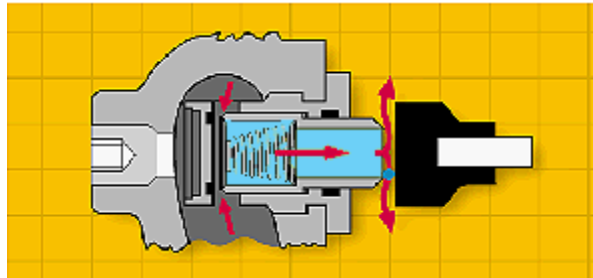

B. Standard regulator orifice failed; upstream monitor orifice control.

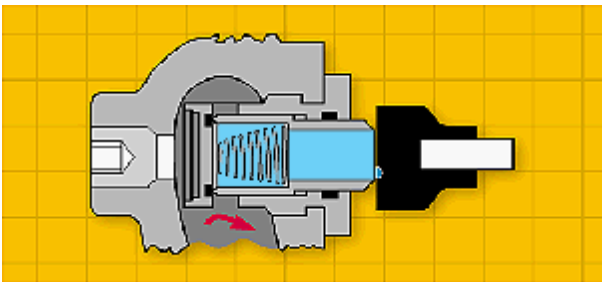

C. Main orifice failed - upstream monitor orifice lock-up.

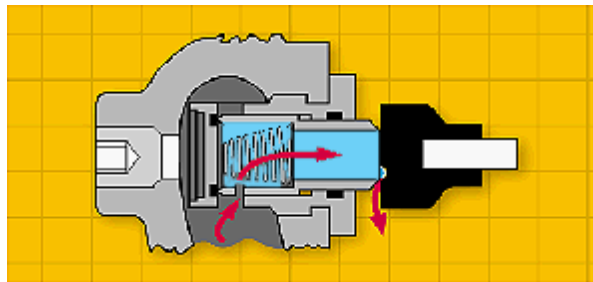

D. V option - vents a small volume of gas to atmosphere through relief valve.



PRINCIPLE OF OPERATION

A. Normal operation. The internal monitor IM orifice performs like a standard regulator and monitor regulator in that main orifice and valve seat actuate to control outlet flow and pressure under normal flow conditions. If there is no demand, the main seat and internal monitor orifice will close.

B. Monitor operation. If the main valve seat fails to control the gas flow and pressure due to foreign matter between the seat and orifice face, or if the seat is eroded, the internal monitor orifice automatically goes into operating position at a slightly higher outlet pressure (see Internal Monitor Lock-up Pressure table). Any time the pressure on the main diaphragm exceeds the force of the fixed monitor spring, the increased outlet pressure causes the main valve seat to push against the sliding orifice. The sliding orifice compresses the monitor spring and positions the monitor orifice to control the gas flow. The IM orifice now functions as a monitor regulator and continues to monitor as long as the main seat fails to control at the normal adjusted outlet pressure. If the gas load demand is increased beyond the internal monitor's capacity, the outlet pressure is reduced to normal adjusted pressure and the regulator resumes normal regulation.

C. Monitor lock-up. If the demand for gas is decreased to zero flow during monitor operation, the sliding orifice continues to close until its orifice is in the gas tight position (monitor lock-up) against the BUNA-N monitor valve seat. (See the Internal Monitor Lock-up Pressure table for the outlet pressure required for internal monitor lock-up.)

D. Vent hole V option. On installations where a small volume of over-pressure gas can be safely vented to the atmosphere, the advantages of both the pilot relief valve and monitor safety can be combined. If the flow is decreased to zero or just greater than zero, the vent hole in the internal monitor orifice allows gas to slowly bleed downstream and cause the pressure to rise to the relief point of the pilot's internal relief valve. The gas then bleeds to the atmosphere indicating a problem with the regulator.

RECOMMENDED LOADING RING SETTINGS FOR B34IM

Outlet Pressure	Inlet Pressure	Setting
1 PSIG or less	50 PSIG or less	18° off center line
-	> 50 PSIG	21° off center line
1 PSIG through 2 PSIG	-	12°
> 2 PSIG	-	0°

Exact loading ring settings may vary slightly with individual pressure and load conditions. Optimum setting should be determined by field installations.

B34 IM MAXIMUM INLET PRESSURE DATA

Orifice Size (inches)	Max. Inlet Pressure	
	w.c. Outlet	PSIG Outlet
3/4	60	150
5/8	60	150
1/2	75	150
3/8	125	150

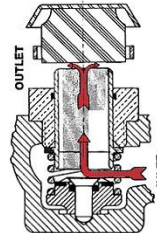

B34 IM SPRING RANGES

Models B34 IM, IMR, IMRV, IMN		
Spring Color	Part Number	Outlet Pressure Range
Brown	762351	4.5" w.c. - 5.5" w.c.
Green/white	762321	5.5" w.c. - 7.2" w.c.
Black	762355	7.2" w.c. - 13.5" w.c.
Purple	762365	13.0" w.c. - 20.0" w.c.
Blue/white	762358	0.6 PSIG - 1.2 PSIG
Silver/red	762323	0.8 PSIG - 2.2 PSIG
Yellow	762361	0.5 PSIG - 4.4 PSIG
Red-nested	762671	1.8 PSIG - 5.8 PSIG

B34 IMRV

Main Spring Color	Outlet Pressure Set	Maximum Downstream Pressure Buildup			
		B34IMR & B34IMN	Standard Relief Spring B34IMRV, Signal Point	Brown/white Relief Spring B34IMRV, Signal Point	Green Relief Spring B34IMRV, Signal Point
Brown	5.5" w.c.	10.5" w.c.	13.0" w.c.	-	-
Green/White	7.0" w.c.	11.5" w.c.	14.5" w.c.	-	-
Black	11.0" w.c.	16.0" w.c.	20.0" w.c.	-	-
Purple	14.0" w.c.	23.0" w.c.	28.0" w.c.	-	-
Blue	20.0" w.c.	26.0" w.c.	30.0" w.c.	-	-
Blue/white	1 PSIG	1.4 PSIG	1.5 PSIG	2.0 PSIG	-
Silver/red	2 PSIG	2.5 PSIG	2.6 PSIG	3.2 PSIG	-
Yellow	3 PSIG	3.7 PSIG	3.9 PSIG	5.0 PSIG	6.4 PSIG
Red	5 PSIG	6.1 PSIG	6.6 PSIG	8.0 PSIG	8.9 PSIG

B34IMRV Flow Chart						
Vented gas flow, regulator seat failed; monitor seat closed						
Inlet Pressure PSIG	20	40	60	75	100	125
Flow SCFH	60	90	120	150	190	230

B34IM SERIES COMMERCIAL REGULATOR, MODELS IMR, IMRV, AND IMN

7" w.c. (17.5 mbar) Capacity Table (1" w.c. Absolute Droop*) 2" Outlet

Capacities in SCFH of 0.6 S.G. gas; base conditions of 14.7 PSIA and 60° F.

Typical Capacity Info.		Inlet Pressure		Orifice Size							
		PSIG	Bar	3/8"		1/2"		5/8"		3/4"	
Manufacturer	Itron	1	0.020	650	(18.4)	950	(26.9)	1100	(31.1)	1400	(39.6)
Type and model	B34IMR	2	0.025	1000	(28.3)	1350	(38.2)	1900	(53.8)	2200	(62.2)
Regulator		3	0.030	1200	(33.9)	1750	(19.5)	2400	(67.9)	3000	(84.9)
Inlet size	2" NPT	5	0.035	1800	(50.9)	2500	(70.8)	3200	(90.6)	4500	(127.4)
Outlet size	2" NPT	10	0.040	2800	(79.2)	3650	(103.3)	6500	(184.0)	7500	(212.3)
Spring color	Green/white	20	0.045	4500	(127.4)	7800	(220.8)	9200	(260.5)	10000	(283.0)
Position	11	30	0.052	5800	(164.2)	9500	(269.0)	10000	(283.0)	10000	(283.0)
		40	0.60	7000	(198.2)	9850	(278.9)	10000	(283.0)	10000	(283.0)
		50	0.069	8650	(244.9)	10000	(283.0)	10000	(283.0)	10000	(283.0)
		60	0.138	10000	(283.0)	10000	(283.0)	10000	(283.0)	10000	(283.0)
		70	0.207	10000	(283.0)	10000	(283.0)				
		80	0.345	10000	(283.0)						
		90	0.69	10000	(283.0)						
		100	1.38	10000	(283.0)						
		125	2.07	10000	(283.0)						

Inlet Effect ^A PSIG (mbar)	0.3 (0.8)	0.4 (1.0)	0.5 (1.3)	0.5 (1.3)
Lock Up ^B PSIG (mbar)	0.3 (0.8)	0.3 (0.8)	0.4 (1.0)	0.4 (1.0)

Notes:

*Individual regulator performance may vary from data shown.

A. Change in outlet pressure for 10 PSIG inlet pressure change.

B. Outlet pressure increase required for lock up.

[REDACTED] Do not operate the orifice in the shaded inlet pressure area.

B34 SERIES COMMERCIAL REGULATOR, MODELS IMR, IMRV, AND IMN

14" w.c. (34.4 mbar) Capacity Table (2" w.c. Droop*) 2" Outlet

Capacities in SCFH of 0.6 S.G. gas; base conditions of 14.7 PSIA and 60°F.

Typical Capacity Info.	
Manufacturer	Itron
Type and model	B34IMR
Regulator	
Inlet size	2" NPT
Outlet size	2" NPT
Spring color	Purple
Position	11

Inlet Pressure		Orifice Size							
		3/8"		1/2"		5/8"		3/4"	
PSIG	Bar								
1	0.020	500	(14.1)	850	(24.0)	900	(25.4)	1100	(31.1)
2	0.025	900	(25.4)	1350	(38.2)	1500	(42.4)	1850	(52.3)
3	0.030	1200	(33.9)	1750	(19.5)	2000	(56.6)	2450	(69.3)
5	0.035	1800	(50.9)	2500	(70.8)	3000	(84.9)	3500	(99.1)
10	0.040	2600	(73.6)	3500	(99.1)	5000	(141.5)	5300	(150.0)
20	0.045	4300	(121.7)	7500	(212.3)	9000	(254.8)	9500	(269.0)
30	0.052	5600	(158.5)	8200	(232.1)	9700	(274.6)	10000	(283.0)
40	0.60	6700	(189.7)	9500	(269.0)	10000	(283.0)	10000	(283.0)
50	0.069	8250	(233.6)	10000	(283.0)	10000	(283.0)	10000	(283.0)
60	0.138	1000	(283.0)	10000	(283.0)	10000	(283.0)	10000	(283.0)
70	0.207	10000	(283.0)	10000	(283.0)				
80	0.345	10000	(283.0)						
90	0.69	10000	(283.0)						
100	1.38	10000	(283.0)						
125	2.07	10000	(283.0)						

Inlet Effect ^A PSIG (mbar)	0.3 (0.8)	0.4 (1.0)	0.5 (1.3)	0.5 (1.3)
Lock Up ^B PSIG (mbar)	0.3 (0.8)	0.3 (0.8)	0.4 (1.0)	0.4 (1.0)

Notes:

*Individual regulator performance may vary from data shown.

A. Change in outlet pressure for 10 PSIG inlet pressure change.

B. Outlet pressure increase required for lock up.

[REDACTED] Do not operate the orifice in the shaded inlet pressure area.

B34 SERIES COMMERCIAL REGULATOR, MODELS IMR, IMRV, AND IMN

1 PSIG (68.9 mbar) Capacity Table (1% Absolute Droop*) 2" Outlet

Capacities in SCFH of 0.6 S.G. gas; base conditions of 14.7 PSIA and 60°F.

Typical Capacity Info.		Inlet Pressure		Orifice Size							
		PSIG	Bar	3/8"		1/2"		5/8"		3/4"	
Manufacturer	Itron	2	0.025	800	(22.6)	1200	(33.9)	1500	(42.4)	1700	(48.1)
Type and model	B34IMR	3	0.030	1100	(31.1)	1650	(46.7)	1900	(53.8)	2300	(65.1)
Regulator		5	0.035	1500	(42.4)	2300	(65.1)	2500	(70.8)	3400	(96.2)
Inlet size	2" NPT	10	0.040	2500	(70.8)	3400	(96.2)	4700	(133.0)	5200	(147.2)
Outlet size	2" NPT	20	0.045	4200	(118.9)	7400	(209.5)	8500	(240.6)	9200	(260.5)
Spring color	Blue/white	30	0.052	5300	(150.0)	8000	(226.5)	9700	(274.6)	10000	(283.0)
Position	11	40	0.60	6500	(184.0)	9400	(266.1)	10000	(283.0)	13000	(368.1)
		50	0.069	8000	(226.5)	9800	(277.5)	10000	(283.0)	15000	(424.7)
		60	0.138	9000	(254.8)	10000	(283.0)	17000	(481.3)	17500	(495.5)
		70	0.207	10000	(283.0)	15000	(424.7)	18500	(523.8)	19000	(538.0)
		80	0.345	11500	(325.6)	17000	(481.3)	20000	(566.3)	20000	(566.3)
		90	0.69	12000	(339.8)	18000	(509.7)	20000	(566.3)	20000	(566.3)
		100	1.38	13500	(382.2)	20000	(566.3)	20000	(566.3)	20000	(566.3)
		125	2.07	14000	(396.4)	20000	(566.3)	20000	(566.3)	20000	(566.3)

Inlet Effect ^A PSIG (mbar)	0.3 (0.8)	0.4 (1.0)	0.5 (1.3)	0.5 (1.3)
Lock Up ^B PSIG (mbar)	0.3 (0.8)	0.3 (0.8)	0.4 (1.0)	0.4 (1.0)

Notes:

*Individual regulator performance may vary from data shown.

A. Change in outlet pressure for 10 PSIG inlet pressure change.

B. Outlet pressure increase required for lock up.

B34 SERIES COMMERCIAL REGULATOR, MODELS IMR, IMRV, AND IMN

1 PSIG (68.9 mbar) Capacity Table (2% Absolute Droop*) 2" Outlet

Capacities in SCFH of 0.6 S.G. gas; base conditions of 14.7 PSIA and 60°F.

Typical Capacity Info.		Inlet Pressure		Orifice Size							
		PSIG	Bar	3/8"		1/2"		5/8"		3/4"	
Manufacturer	Itron	2	0.025	900	(26.9)	1350	(38.2)	1900	(53.8)	2000	(56.6)
Type and model	B34IMR	3	0.030	1300	(36.8)	1800	(50.9)	2200	(62.2)	2600	(73.6)
Regulator		5	0.035	1800	(50.9)	2700	(76.4)	3300	(93.4)	4200	(118.9)
Inlet size	2" NPT	10	0.040	3000	(84.9)	4700	(133.0)	5800	(164.2)	7300	(206.7)
Outlet size	2" NPT	20	0.045	4500	(127.4)	8000	(226.5)	9200	(260.5)	11000	(311.4)
Spring color	Blue/white	30	0.052	6000	(169.9)	9000	(254.8)	10500	(297.3)	13000	(368.1)
Position	11	40	0.60	6800	(192.5)	9500	(269.0)	12000	(339.8)	18000	(509.7)
		50	0.069	9000	(254.8)	10000	(283.0)	12000	(339.8)	18000	(509.7)
		60	0.138	10500	(297.3)	11000	(311.4)	18000	(509.7)	20000	(566.3)
		70	0.207	11500	(325.6)	15500	(438.9)	19200	(543.6)	20000	(566.3)
		80	0.345	12000	(339.8)	18000	(509.7)	20000	(566.3)	20000	(566.3)
		90	0.69	13000	(368.1)	20000	(566.3)	20000	(566.3)	20000	(566.3)
		100	1.38	14500	(410.5)	20000	(566.3)	20000	(566.3)	20000	(566.3)
		125	2.07	16000	(453.0)	20000	(566.3)	20000	(566.3)	20000	(566.3)

Inlet Effect ^A PSIG (mbar)	0.3 (0.8)	0.4 (1.0)	0.5 (1.3)	0.5 (1.3)
Lock Up ^B PSIG (mbar)	0.3 (0.8)	0.3 (0.8)	0.4 (1.0)	0.4 (1.0)

Notes:

*Individual regulator performance may vary from data shown.

A. Change in outlet pressure for 10 PSIG inlet pressure change.

B. Outlet pressure increase required for lock up.

B34 SERIES COMMERCIAL REGULATOR, MODELS IMR, IMRV, AND IMN

2 PSIG (137.8 mbar) Capacity Table (1% Absolute Droop*) 2" Outlet

Capacities in SCFH of 0.6 S.G. gas; base conditions of 14.7 PSIA and 60°F.

Typical Capacity Info.	Inlet Pressure		Orifice Size							
	PSIG	Bar	3/8"		1/2"		5/8"		3/4"	
Manufacturer Itron	3	0.030	650	(18.4)	900	(25.4)	1400	(39.6)	1650	(46.7)
Type and model B34IMR	5	0.035	1000	(28.3)	1700	(48.1)	2350	(66.5)	2850	(80.7)
Regulator	10	0.040	1900	(53.8)	3000	(84.9)	4450	(126.0)	5000	(141.5)
Inlet size 2" NPT	20	0.045	3000	(84.9)	6000	(169.9)	7000	(198.2)	9000	(254.8)
Outlet size 2" NPT	30	0.052	4500	(127.4)	7500	(212.3)	9500	(269.0)	9800	(277.5)
Spring color Silver/red	40	0.60	6000	(169.9)	8500	(240.6)	9850	(278.9)	11000	(311.4)
Position 11	50	0.069	6900	(195.3)	9600	(271.8)	10000	(283.0)	14000	(396.4)
	60	0.138	8950	(253.4)	10000	(283.0)	15000	(424.7)	17000	(481.3)
	70	0.207	9800	(277.5)	14000	(396.4)	18000	(509.7)	18900	(535.1)
	80	0.345	11000	(311.4)	15500	(438.9)	20000	(566.3)	20000	(566.3)
	90	0.69	11500	(325.6)	16500	(467.2)	20000	(566.3)	20000	(566.3)
	100	1.38	13000	(368.1)	19000	(538.0)	20000	(566.3)	20000	(566.3)
	125	2.07	13900	(393.0)	20000	(566.3)	20000	(566.3)	20000	(566.3)

Inlet Effect ^A PSIG (mbar)	0.3 (0.8)	0.4 (1.0)	0.5 (1.3)	0.5 (1.3)
Lock Up ^B PSIG (mbar)	0.3 (0.8)	0.3 (0.8)	0.4 (1.0)	0.4 (1.0)

Notes:

*Individual regulator performance may vary from data shown.

A. Change in outlet pressure for 10 PSIG inlet pressure change.

B. Outlet pressure increase required for lock up.

B34 SERIES COMMERCIAL REGULATOR, MODELS IMR, IMRV, AND IMN

2 PSIG (137.8 mbar) Capacity Table (2% Absolute Droop*) 2" Outlet

Capacities in SCFH of 0.6 S.G. gas; base conditions of 14.7 PSIA and 60°F.

Typical Capacity Info.		Inlet Pressure		Orifice Size							
		PSIG	Bar	3/8"		1/2"		5/8"		3/4"	
Manufacturer	Itron	3	0.030	1000	(28.3)	1200	(33.9)	1600	(45.3)	1650	(46.7)
Type and Regulator	B34IMR	5	0.035	1700	(48.1)	2000	(56.6)	2500	(70.7)	2900	(82.1)
Inlet size	2" NPT	10	0.040	2500	(70.7)	3400	(96.2)	4500	(127.4)	5300	(150.0)
Outlet size	2" NPT	20	0.045	4000	(113.2)	7000	(198.2)	9000	(254.8)	10100	(286.0)
Spring color	Silver/red	30	0.052	5400	(152.9)	8000	(226.5)	10000	(283.0)	10500	(297.3)
Position	11	40	0.60	7500	(212.3)	9000	(254.8)	10500	(297.3)	12500	(353.9)
		50	0.069	8000	(226.5)	10000	(283.0)	15000	(424.7)	16000	(453.0)
		60	0.138	10000	(283.0)	16000	(453.0)	17000	(481.3)	18000	(509.7)
		70	0.207	10500	(297.3)	15000	(424.7)	19000	(538.0)	20000	(566.3)
		80	0.345	12500	(353.9)	16500	(467.2)	20000	(566.3)	20000	(566.3)
		90	0.69	13500	(382.2)	18200	(515.3)	20000	(566.3)	20000	(566.3)
		100	1.38	15000	(424.7)	20000	(538.0)	20000	(566.3)	20000	(566.3)
		125	2.07	16000	(453.0)	20000	(566.3)	20000	(566.3)	20000	(566.3)

Inlet Effect ^A PSIG (mbar)	0.3 (0.8)	0.4 (1.0)	0.5 (1.3)	0.5 (1.3)
Lock Up ^B PSIG (mbar)	0.3 (0.8)	0.3 (0.8)	0.4 (1.0)	0.4 (1.0)

Notes:

*Individual regulator performance may vary from data shown.

A. Change in outlet pressure for 10 PSIG inlet pressure change.

B. Outlet pressure increase required for lock up.

B34 SERIES COMMERCIAL REGULATOR, MODELS IMR, IMRV, AND IMN

5 PSIG (137.8 mbar) Capacity Table (1% Absolute Droop*) 2" Outlet

Capacities in SCFH of 0.6 S.G. gas; base conditions of 14.7 PSIA and 60°F.

Typical Capacity Info.	Inlet Pressure		Orifice Size							
	PSIG	Bar	3/8"		1/2"		5/8"		3/4"	
Manufacturer Itron	10	0.040	800	(22.6)	1000	(28.3)	1100	(31.1)	1500	(42.4)
Type and model B34IMR	20	0.045	1300	(36.8)	1550	(43.8)	1850	(52.3)	2200	(62.2)
Regulator	30	0.052	2000	(56.6)	2450	(69.3)	2600	(73.6)	2800	(79.2)
Inlet size 2" NPT	40	0.60	2500	(70.7)	3000	(84.9)	3500	(99.1)	3600	(101.9)
Outlet size 2" NPT	50	0.069	2900	(82.1)	3500	(99.1)	3850	(109.0)	4200	(118.9)
Spring color Red	60	0.138	3100	(87.7)	4700	(133.0)	5000	(141.5)	6000	(169.9)
Position 11	70	0.207	3800	(107.6)	4850	(137.3)	6500	(184.0)	7500	(212.3)
	80	0.345	4300	(121.7)	5400	(152.9)	7000	(198.2)	8000	(226.5)
	90	0.69	4700	(133.0)	6000	(169.9)	8000	(226.5)	9500	(269.0)
	100	1.38	5100	(144.4)	6600	(186.8)	9000	(254.8)	10000	(283.1)
	125	2.07	6300	(178.3)	8000	(226.5)	9500	(269.0)	11000	(311.4)

Inlet Effect ^A PSIG (mbar)	0.3 (0.8)	0.4 (1.0)	0.5 (1.3)	0.5 (1.3)
Lock Up ^B PSIG (mbar)	0.3 (0.8)	0.3 (0.8)	0.4 (1.0)	0.4 (1.0)

Notes:

*Individual regulator performance may vary from data shown.

A. Change in outlet pressure for 10 PSIG inlet pressure change.

B. Outlet pressure increase required for lock up.

B34 SERIES COMMERCIAL REGULATOR, MODELS IMR, IMRV, AND IMN

5 PSIG (137.8 mbar) Capacity Table (2% Absolute Droop*) 2" Outlet

Capacities in SCFH of 0.6 S.G. gas; base conditions of 14.7 PSIA and 60°F.

Typical Capacity Info.	Inlet Pressure		Orifice Size							
	PSIG	Bar	3/8"		1/2"		5/8"		3/4"	
Manufacturer Itron	10	0.040	1000	(28.3)	1500	(42.4)	1700	(48.1)	1900	(53.8)
Type and model B34IMR	20	0.045	1900	(53.8)	2500	(70.7)	2650	(75.0)	3600	(101.9)
Regulator	30	0.052	2500	(70.7)	4400	(124.5)	3950	(111.8)	5400	(152.9)
Inlet size 2" NPT	40	0.60	3300	(93.4)	5200	(147.2)	5500	(155.7)	6900	(195.3)
Outlet size 2" NPT	50	0.069	4600	(130.2)	6300	(178.3)	7100	(201.0)	8500	(240.6)
Spring color Red	60	0.138	5400	(152.9)	7500	(212.3)	8500	(240.6)	9800	(277.5)
Position 11	70	0.207	5900	(167.0)	7800	(220.8)	9000	(254.8)	10500	(297.3)
	80	0.345	6500	(184.0)	8200	(232.1)	10500	(297.3)	11500	(325.6)
	90	0.69	7300	(206.7)	10200	(288.8)	11500	(325.6)	12500	(353.9)
	100	1.38	8000	(226.5)	11000	(311.4)	12000	(339.8)	13000	(368.1)
	125	2.07	9800	(277.5)	13600	(385.1)	14500	(410.5)	15000	(424.7)

Inlet Effect ^A PSIG (mbar)	0.3 (0.8)	0.4 (1.0)	0.5 (1.3)	0.5 (1.3)
Lock Up ^B PSIG (mbar)	0.3 (0.8)	0.3 (0.8)	0.4 (1.0)	0.4 (1.0)

Notes:

*Individual regulator performance may vary from data shown.

A. Change in outlet pressure for 10 PSIG inlet pressure change.

B. Outlet pressure increase required for lock up.

B34 PERFORMANCE CURVES

7" w.c. Set Point

Inlet Size	1-1/2" NPT
Outlet Size	2" NPT
Inlet Pressure	20 PSIG at set
Orifice Size	3/4"
Spring Range	5.1 to 7.0" w.c.
Bolt Circle Diameter	12-1/16"
Flow Rate at Set	200 SCFH

- A. 60 PSIG inlet pressure W.O.R.
- B. 40 PSIG inlet pressure SET
- C. 25 PSIG inlet pressure W.O.R.

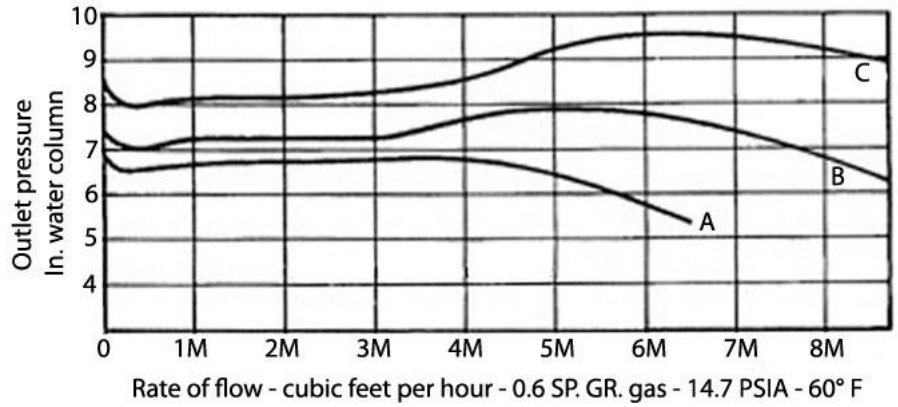

RELIEF MONITOR CURVES

7" w.c. Set Point

Inlet Size	2" NPT
Outlet Size	2" NPT
Inlet Pressure	20 PSIG at set
Orifice Size	3/4"
Spring Range	5.5 to 7.2" w.c.
Bolt Circle Diameter	12-1/16"
Flow Rate at Set	200 SCFH

- A. 60 PSIG inlet pressure W.O.R.
- B. 40 PSIG inlet pressure SET
- C. 25 PSIG inlet pressure W.O.R.

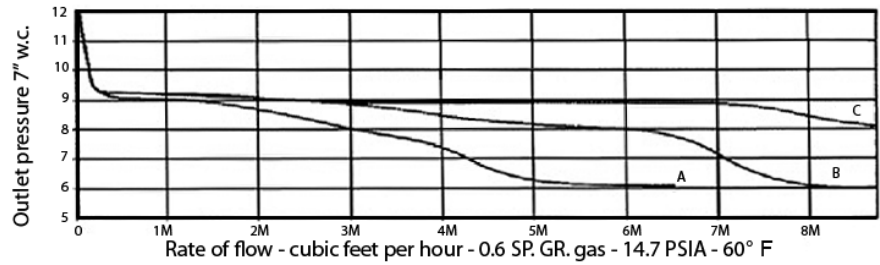

RELIEF MONITOR CURVES

2 PSIG Set Point

Inlet Size	2" NPT
Outlet Size	2" NPT
Inlet Pressure	40 PSIG at set
Orifice Size	3/4"
Spring Range	0.8 to 2.2 PSIG
Bolt Circle Diameter	12-1/16"
Flow Rate at Set	200 SCFH
Position	9
Loading Ring	Set at 12°

- A. 60 PSIG inlet pressure W.O.R.
- B. 40 PSIG inlet pressure SET
- C. 25 PSIG inlet pressure W.O.R.
- D. 40 PSIG inlet pressure, failed condition
- E. 60 PSIG inlet pressure, failed condition

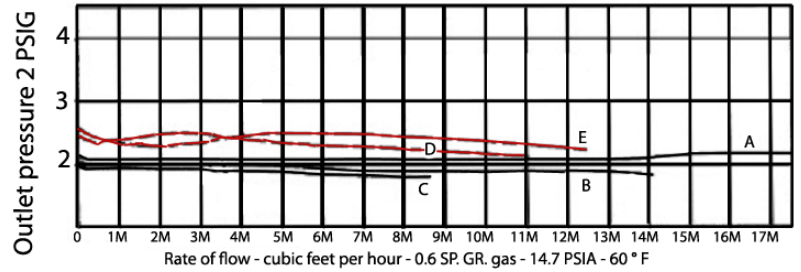

- A, B, C. Normal regulator operation.
- D, E. Main seat failed open with 1/8" x 1/2" diameter nylon disc.
Internal monitor orifice in operation.

RELIEF MONITOR CURVES

5 PSIG Set Point

Inlet Size	2" NPT
Outlet Size	2" NPT
Inlet Pressure	40 PSIG at set
Orifice Size	3/4"
Spring Range	1.8 to 5.8 PSIG
Bolt Circle Diameter	12-1/16"
Flow Rate at Set	200 SCFH
Position	9
Loading Ring	Set at 0°

- A. 60 PSIG inlet pressure W.O.R. 19M @4.89 PSIG
- B. 40 PSIG inlet pressure SET
- C. 25 PSIG inlet pressure W.O.R.
- D. 40 PSIG inlet pressure failed condition
- E. 60 PSIG inlet pressure failed condition

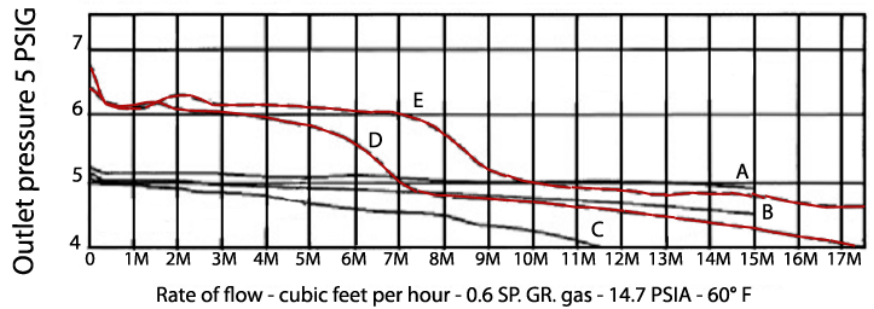

ASSEMBLY POSITIONS

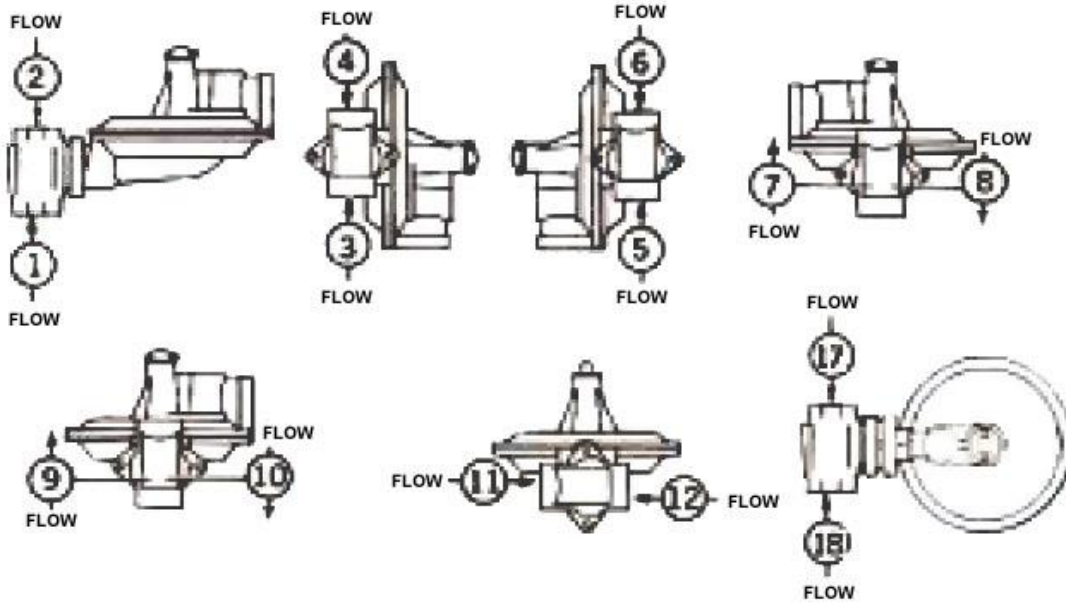

PARTS LIST

B34 R, N, M, D, IMR, IMRV, IMN

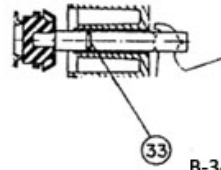

B-34 M & RM Only

Optional PSI to PSI relief only

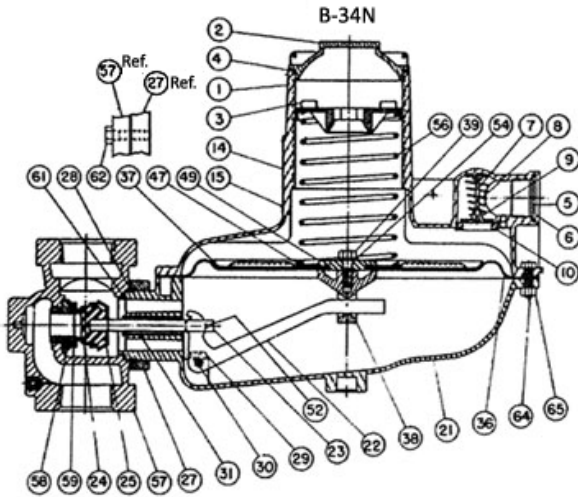

B34N Reference Schematic

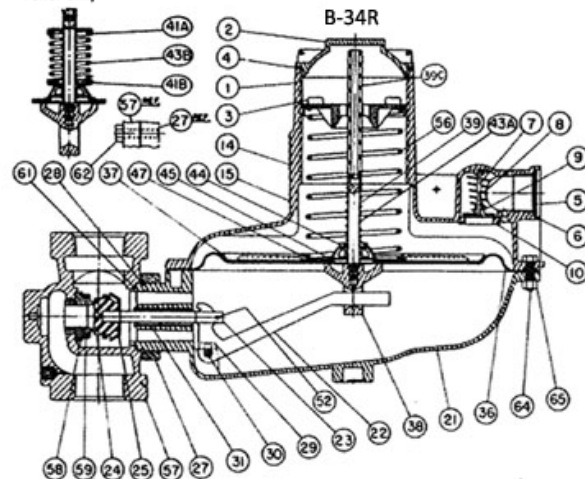

B34R Reference Schematic

Item Number	Part Number	Quantity Required per Regulator Model				Description
		D	M	R/IMR	N/IMN	
1						Upper diaphragm case assembly, please specify
	710040	1	1	1	1	1" NPT vent, #10 breather hole, standard
	710088	1	1	1	1	1" BSP vent, #10 breather hole
	710089	1	1	1	1	1" NPT vent, no breather hole
	710100	1	1	1	1	1: NPT vent, #44 breather hole
2	760083	1	1	1	1	Seal cap
3	760233	1	1	1	1	Adjustment screw
4	765607	1	1	1	1	Seal cap gasket
5	762933	1	1	1	1	Vent screen
6	75579101	1	1	1	1	Vent screen retainer ring
7	75483401	1	1	1	1	Vent valve disc pin
8	762601	1	1	1	1	Vent valve spring, 1/2 oz.
9	765181	1	1	1	1	Vent valve disc
10	765685	1	1	1	1	Vent valve seat
14	769250	1	1	1	1	Regulator badge
15	755071	2	2	2	2	Badge screw
21						Lower diaphragm case
	715050			1	1	B34R, IMR, N, and IMN lower diaphragm case
	715052	1	1			B34 IM and D lower diaphragm case
22						Valve lever
	761275			1	1	B34R, IMR, N, and IMN lever
	761271	1	1			B34M, and D lever
23						Valve stem
	754151			1	1	B34R, IMR, N, and IMN stem only
	754152			1	1	B34R, IMR, N, and IMN stem with roll pin
	754154	1	1			B34M and D stem only
24						Valve seat
	765201	1	1	1	1	B34R, N, D, and M valve seat
	765203					BB34IMR and IMN valve seat with white stripe
25						Deflector ring
	761721	1	1	1	1	Deflector ring, standard
	761723	1	1	1	1	Deflector ring, IM version only
27	751913SU	1	1	1	1	Valve body retainer plate-aluminum
28	755725	1	1	1	1	Retainer rate snap ring
29	755223	2	2	2	2	Valve linkage pin screw
30	754836	1	1	1	1	Valve linkage pin
33	765505		1			Valve stem O-ring
36	766301	1	1	1	1	Diaphragm
37	76104101	1	1	1	1	Upper diaphragm plate
36 and 37	720101	1	1	1	1	Diaphragm/plate assembly

Item Number	Part Number	Quantity Required per Regulator Model				Description
		D	M	R/IMR	N/IMN	
38						Lower diaphragm plate
	756073					With bead, all R versions
	756075					No bead, all N versions
39	754375			1		Stop stem, assembly self-aligning
41A	761451			1		Relief spring guide, PSI relief
41B	761431			1		Relief spring guide, use with brown & green relief spring
43A				1		Relief spring: please specify
	762301					7" w.c. above set (standard)
43B				1		Relief spring - specify color:
	762401					Brown/white .5 PSIG above set
	762403					Green 1.0 PSIG above set
44	754931			1		Stop stem guide bushing
45	76166501			1		Relief cap
47						Adjustment spring guide, please specify:
	761481			1		Adjustment spring guide, internal relief
	761483	1	1		1	Adjustment spring guide, non-relieving regulators
49	761081	1	1		1	Secondary diaphragm plate
52						Valve stem slot pin
	755007			1	1	Valve stem slot pin
	755009	1	1			Valve stem slot pin
54	755851					Diaphragm plate washer lock
56		1	1	1	1	Adjustment spring
	762351					Brown
	762353					Green
	762355					Black
	762357					Blue
	762359					Silver
	762361					Yellow
	762671					Red-Nested
	762673					White-Nested
	762321					Green/White
	762323					Silver/Red
	762365					Purple
	762341					Orange
	762345					Orange/Green
	762358					Blue/White
57		1	1	1	1	NPT valve bodies, please specify type & size
	750604					1-1/4" x 1-1/4"
	750605					1-1/4" x 1-1/4" BSPT
	750607					1-1/4" x 1-1/4" tap
	750616					1-1/4" x 1-1/4" IM test tap
	750627					1-1/4" x 1-1/2"

Item Number	Part Number	Quantity Required per Regulator Model				Description
		D	M	R/IMR	N/IMN	
57 (cont.)		1	1	1	1	NPT valve bodies, please specify type & size
	750630					1-1/4" x 1-1/2" 1/8" tap
	750639					1-1/4" x 1-1/2" IM test tap
	750654					1-1/4" x 2"
	750657					1-1/4" x 2-1/8" tap
	750666					1-1/4" x 2" IM test tap
	750676					1-1/2" x 1-1/2"
	750678					1-1/2" x 1-1/2" BSPT
	750679					1-1/2" x 1-1/2" BSP
	750680					1-1/2" x 1-1/2" 1/8" tap
	750693					1-1/2" x 1-1/2" IM test tap
	750704					1-1/2" x 2"
	750707					1-1/2" x 2" 1/8" tap
	750716					1-1/2" x 2" IM test tap
	750726					2" x 2" NPT
	750728					2" x 2" BSPT
	750729					2" x 2" BSP
	750730					2" x 2-1/8" tap
						Flanged valve bodies
	750754					2" x 2" ASA 125 flat-face flange 10" length
	750757					2" x 2" ASA 125 flat-face flange 10" length, 1/8" tap
	750777					2" x 2" ASA 125 flat-face flange 7.5" length
	750780					2" x 2" ASA 125 flat-face flange 7.5" length, 1/8" tap
	750804					3" x 3" ASA 125 flat-face flange
	750807					3" x 3" ASA 125 flat-face flange, 1/8" tap
58		1	1	1	1	Orifice, specify type & size
	758101					orifice 1/4"
	758104					orifice 3/8"
	758107					orifice 1/2"
	758110					orifice 5/8"
	758113					orifice 3/4"
	758117					orifice 7/8"
	758150					orifice 7/32" x 1/4"
	758151					orifice 1/4" x 3/8"
	758154					orifice 5/16" x 3/8"
	758157					orifice 3/8" x 1/2"
	758160					orifice 1/2" x 5/8"
	758163					orifice 5/8" x 3/4"
	758166					orifice 3/4" x 7/8"
	758169					orifice 7/8" x 1"
61	765651	1	1	1	1	Valve body gasket, standard
62	755386-001	2	2	2	2	Retaining plate screw 5/16-18 x 1-1/4 Hex head slotted

Item Number	Part Number	Quantity Required per Regulator Model				Description
		D	M	R/IMR	N/IMN	
64	755311-001	12	12	12	12	Case screw, 1/4-20 x 1 Hex head
65	755513-001	12	12	12	12	Case screw nut, 1/4-20 Hex head
Sub-assemblies						
	715016			1	1	B34R, IMR, N, and IMN Lower diaphragm case assembly
	715018		1			B34M lower diaphragm case assembly
	715063	1				Lower diaphragm case assembly
	720025			1		Diaphragm assembly, relief (standard)
	720026					Diaphragm assembly, brown relief spring
	720027					Diaphragm assembly, green relief spring
	720028	1	1	1	1	Diaphragm assembly, 10" w.c. above set point relief spring
Torque Specifications						
			Retainer Plate Screws			100 in. lbs
			Orifice			600 in. lbs
			Orifice (IM & SO)			300 in. lbs
			Margin Screws			50 in. lbs
	80002001					Seal wire, no lead 10 in.
Special Parts						
	799021					Orifice wrench
	799055					Adjustment wrench
	799081					Loading ring position tool
	754852					Vent valve reducer #31
	754853					Vent valve reducer #44
	80002002					Seal wire, no lead 24 in.

IM Orifice Assembly Schematic

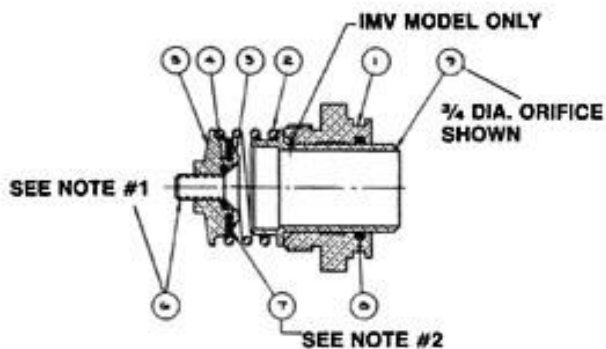

Note 1: Apply Loctite (screw-lock) to end threads of item #6 before assembling in valve body.

Note 2: Cement item #7 to item #5 before assembling valve body.

Internal Monitor (IM) Orifice Assembly Numbers						
Item Number	Part Number	759127	759125	759123	759121	Description
9	758231	1	-	-	-	3/4" diameter sliding orifice
9	758241	-	1	-	-	5/8" diameter sliding orifice
9	758238	-	-	-	1	1/2" diameter sliding orifice
9	758235	-	-	-	1	3/8" diameter sliding orifice
8	765501	1	1	1	1	O-ring
7	765741	1	1	1	1	Monitor seat
6	755131	1	1	1	1	Socket flat head screw
5	756103	1	1	1	1	Anchor
4	765509	1	1	1	1	O-ring
3	754511	1	1	1	1	Anchor plate
2	762311	1	1	1	1	Cut off spring
1	758221	1	1	1	1	Stationary orifice
All of the above parts are interchangeable						

Internal Monitor (IM) Orifice Assembly with Vent Hole "V" Option						
Item Number	Part Number	759127	759125	759123	759121	Description
9	758251	1	-	-	-	3/4" diameter sliding orifice
9	758255	-	1	-	-	3/8" diameter sliding orifice
9	758258	-	-	1	-	1/2" diameter sliding orifice
9	758261	-	-	-	1	5/8" diameter sliding orifice
8	765501	1	1	1	1	O-ring
7	765741	1	1	1	1	Monitor seat
5	756103	1	1	1	1	Anchor
4	765509	1	1	1	1	O-ring
3	754511	1	1	1	1	Anchor plate
2	762311	1	1	1	1	Cut off spring
1	758221	1	1	1	1	Stationary orifice
All of the above parts are interchangeable						

VENT LINES FOR REGULATORS

When constructing vent lines to be attached to regulators installed indoors, follow a few basic rules:

- a. Never use pipe sizes smaller than the vent size; smaller pipe sizes restrict the gas flow. If a long gas run must be used, Itron advises increasing the pipe one nominal size every ten feet to keep the flow restriction as low as possible.
- b. Keep the vent line length as short as possible to minimize the restriction and reduce the vent's tendency to cause regulator pulsation.
- c. Support the vent pipe to eliminate strain on the regulator diaphragm case.
- d. Always point outdoor vent pipes in the downward position to reduce the possibility of rain, snow, sleet, and other moisture entering the pipe. Install a bug screen in the end of the pipe.
- e. Do not locate the vent line terminus near windows, fans, or other ventilation equipment. See the installation instructions furnished with the regulator.
- f. Adhere to all applicable codes and regulations.
- g. If your vent pipe causes regulator pulsation, consult your sales representative or manufacturer.
- h. Itron strongly recommends running a separate vent line for each regulator. Headers with various installed devices can cause regulator malfunction.

Caution Ensure the end of the vent line is away from ANY potential ignition sources. It is the installer's responsibility to ensure the vent line is exhausting to a safe environment.

INSTALLATION

Warning Itron does not endorse or warrant the completeness or accuracy of any third party regulator installation procedures or practices, unless otherwise provided in writing by Itron. Follow your company's standard operating procedures regarding the use of personal protection equipment (PPE). Adhere to guidelines issued by your company in addition to those given in this document when installing regulators.

- a. Remove all shipping plugs from the regulator inlet, outlet, and vent before installation.
- b. Verify the piping interior and regulator inlet and outlet are clean and free of dirt, pipe dope, and other debris. Dirt and other foreign materials entering the regulator can cause a loss of pressure control.
- c. Apply pipe joint sealant to the male pipe threads. Do not use pipe joint material on the regulator's female threads. Joint sealant could become lodged in the regulator and cause a loss of pressure control.
- d. Gas must flow through the regulator's valve body in the direction cast on the regulator body. Gas flowing in the wrong direction can overpressure and cause damage to the regulator.
- e. The pilot diaphragm casing can be mounted in any position relative to the body through a full 360° angle at 90° increments.
- f. When the regulator is installed OUTDOORS, the vent must always be positioned so that rain, snow, moisture or foreign particles cannot enter the vent opening. Itron recommends positioning the pilot vent downward to avoid entry of water or other matter which could interfere with the proper operation of the regulator. The vent should be located away from building eaves, window openings, building air intakes and above the expected snow level at the site. The vent opening should be inspected periodically to insure it does not become blocked by foreign material as outlined in DOT PHMSA-RSPA-2004-19856.
- g. When the regulator is installed INDOORS, the vent must be piped to the outside atmosphere using the shortest length of pipe, the fewest possible pipe elbows, and a pipe diameter as large as the vent size or larger. USING VENT PIPE SMALLER THAN THE VENT CONNECTION LIMITS THE REGULATOR'S INTERNAL RELIEF VALVE CAPACITY. The outlet end of the pipe must be protected from moisture and the entrance of foreign particles. The regulator should be specified by the user with the size vent and pipe threads desired to make the vent pipe connection.

START-UP PROCEDURE

- a. Mount a pressure gauge downstream of the regulator to monitor the downstream pressure.
- b. With the downstream pressure valve closed, slowly open the inlet valve. The outlet pressure should rise to slightly more than the set-point. Verify there are no leaks and all connections are tight.
- c. The regulator was pre-set at the factory to match order specifications. If necessary, adjust the outlet pressure by removing the seal cap on the top of the pilot spring housing and adjusting the ferrule or screw inside the pilot spring housing using a large flat-head screwdriver. With a small amount of gas flowing through the regulator, rotate the pilot ferrule clockwise to raise the outlet pressure or counter-clockwise to lower the outlet pressure.
- d. Replace the seal cap and check for leaks after the desired outlet pressure is achieved.

The regulator is ready for operation.

SAFETY WARNING

This product, as of the date of manufacture, is designed and tested to conform to all governmental and industry safety standards as they may apply to the manufacturer. The purchaser/user of this product must comply with all fire control, building codes, and other safety regulations governing the application, installation, operation, and general use of this regulator to avoid leaking gas hazards resulting from improper installation, startup or use of this product.

Itron strongly recommends installation by a qualified professional and periodic inspection of pressure regulators (inspections may be required by local applicable codes or regulations).

Inspections should include checking for gas quality, cycle numbers, external environmental changes, and operating conditions that impact wear on the regulator's moving parts. To ensure safe and efficient operation of this product, replace worn or damaged parts found during inspection.

LIMITED WARRANTY

Itron, Inc. 2111 North Molter Road Liberty Lake, WA 99019, warrants this gas product against defects in materials and workmanship for the earlier of one (1) year from the date the product is shipped by Itron or a period of one year from the date the product is installed by Itron at the original purchaser's site. During such one-year period, provided that the original purchaser continues to own the product, Itron will, at its sole option, repair any defects, replace the product or repay the purchase price.

» This warranty will be void if the purchaser fails to observe the procedures for installation, operation or service of the product as set forth in the Operating Manual and Specifications for the product or if the defect is caused by tampering, physical abuse or misuse of the product.

- » ITRON SPECIFICALLY DISCLAIMS ALL IMPLIED WARRANTIES INCLUDING THOSE OF MERCHANTABILITY OR OF FITNESS FOR A PARTICULAR PURPOSE. UNDER NO CIRCUMSTANCES WILL ITRON BE LIABLE FOR INCIDENTAL OR CONSEQUENTIAL DAMAGES OF ANY KIND WHATSOEVER.
- » Itron's liability for any claim of any kind, including negligence and breach of warranty for the sale and use of any product covered by or furnished, shall in no case exceed the price allocable to the product or part thereof which gives rise to the claim.
- » In the event of a malfunction of the product, consult your Itron Service Representative or Itron Inc., 2111 North Molter Road Liberty Lake, WA 99019. See Itron Terms and Conditions of Sale for the full and complete terms of the Limited Warranty.

ORDERING INFORMATION

Specify:

1. Inlet and outlet connection size and type
2. Model number
3. Outlet pressure desired
4. Pilot needed
5. Inlet pressure range
6. Type of gas and maximum capacity required
7. Assembly position number (see chart above)
8. Special requirements such as tagging, 1/8" pipe plug tap, seal wire, etc.



Join us in creating a more **resourceful world**.
To learn more visit **itron.com**

CORPORATE HQ

2111 North Molter Road
Liberty Lake, WA 99019 USA

Phone: 1.800.635.5461

Fax: 1.509.891.3355

While Itron strives to make the content of its marketing materials as timely and accurate as possible, Itron makes no claims, promises, or guarantees about the accuracy, completeness, or adequacy of, and expressly disclaims liability for errors and omissions in, such materials. No warranty of any kind, implied, expressed, or statutory, including but not limited to the warranties of non-infringement of third party rights, title, merchantability, and fitness for a particular purpose, is given with respect to the content of these marketing materials. © Copyright 2018 Itron. All rights reserved. 101062SP-06 08/18