

USER'S GUIDE

Vaisala HUMICAP® Hand-Held Humidity and Temperature Meter HM70



PUBLISHED BY

Vaisala Oyj
P.O. Box 26
FIN-00421 Helsinki
Finland

Phone (int.): +358 9 8949 1
Fax: +358 9 8949 2227

Visit our Internet pages at <http://www.vaisala.com/>

© Vaisala 2007

No part of this manual may be reproduced in any form or by any means, electronic or mechanical (including photocopying), nor may its contents be communicated to a third party without prior written permission of the copyright holder.

The contents are subject to change without prior notice.

Please observe that this manual does not create any legally binding obligations for Vaisala towards the customer or end user. All legally binding commitments and agreements are included exclusively in the applicable supply contract or Conditions of Sale.

Table of Contents

CHAPTER 1	
GENERAL INFORMATION	5
About This Manual	5
Version Information	5
General Safety Considerations	5
Recycling	6
Warranty	7
CHAPTER 2	
PRODUCT DESCRIPTION	9
Vaisala HUMICAP[®] Hand-Held Temperature and Humidity Meter HM70	9
Display Parameters	9
CHAPTER 3	
PREPARATIONS BEFORE USE	13
Installing and Recharging the Batteries	13
Turning ON the Device	14
CHAPTER 4	
TAKING MEASUREMENTS	15
Beware of Temperature Differences	16
CHAPTER 5	
BUTTONS, DISPLAYS AND MENUS	17
Buttons and Navigation	17
Basic Display	18
Graphical Display	19
Menus	19
CHAPTER 6	
SETTINGS	21
Pressure Setting	21
Display Settings	22
Quantities and Units	22
Rounding	22
Hold/Save Display	23
Graphic History	23
User Interface	24

Selecting Language.....	24
Automatic Power OFF	25
Changing Shortcut Keys.....	25
Button Click and Backlight on Button Press.....	26
Setting Date and Time.....	26
Device Information	27
Reverting to Factory Settings	27
CHAPTER 7	
RECORDING DATA	29
Recording.....	29
Stopping Recording	30
Viewing Recorded Data.....	30
Checking Memory Status.....	31
Deleting All Recorded Files	31
MI70 Link Program for Transferring Recorded Data to PC	32
MI70 Link Program for Real-Time PC Monitoring.....	32
CHAPTER 8	
OTHER FUNCTIONS.....	33
Setting Alarm Levels	33
Chemical Purge (Optional)	34
Turning Chemical Purge ON	34
Sensor Preheat (Optional)	36
Turning Sensor Preheat ON/OFF.....	37
CHAPTER 9	
CALIBRATION AND ADJUSTMENT OF TRANSMITTERS	39
HM70 in Checking and Adjusting.....	39
Calibration Cables	39
Calibration and Adjustment of HMD/W 60/70, HMD/W 20/30 and HMP130 Series Transmitters.....	40
Calibration and Adjustment of HMT100 Series Transmitters	42
Field Checking and Adjustment Using a Calibrated Reference Probe	42
One-Point Adjustment Using a Calibrator	43
Two-Point Adjustment Using a Calibrator	44
LiCl-NaCl Adjustment	45
Calibration and Adjustment of HMP230/240 Transmitters and HMM210 Modules	45
Field Checking and Adjustment of Humidity by Using a Calibrated Reference Probe	47
1-Point Humidity Adjustment by Using a Calibrator	47
2-Point Adjustment by Using a Calibrator	48
Calibration and Adjustment of HMT320 Series Transmitters	49

Field Checking and Adjustment by Using a Calibrated Reference Probe	50
1-Point Adjustment by Using a Calibrator	50
2-Point Adjustment by Using a Calibrator	51
Calibration and Adjustment of HMT330	
Series Transmitters.....	52
Field Checking and Adjustment by Using a Calibrated Reference Probe	53
1-Point Adjustment by Using a Calibrator	53
2-Point Adjustment by Using a Calibrator	54
LiCl-NaCl Adjustment.....	55
Field Checking of DMW19 Transmitter	56
 CHAPTER 10	
MEASURING OTHER PARAMETERS SIMULTANEOUSLY	57
 CHAPTER 11	
ANALOG OUTPUT CONNECTION	59
Selecting and Scaling the Analog Output	59
 CHAPTER 12	
CALIBRATION AND ADJUSTMENT OF HM70 SERIES PROBES	61
General Information about Calibrations	61
Relative Humidity Adjustment	61
LiCl-NaCl Automatic Adjustment.....	61
2-Point Adjustment.....	62
1-Point Adjustment.....	63
Temperature Adjustment.....	63
1-Point Adjustment.....	64
2-Point Adjustment.....	65
Last Adjustment Date	65
 CHAPTER 13	
MAINTENANCE	67
Changing the Filter.....	67
Changing the Battery Pack.....	67
Error Messages	68
Technical Support	69
Return Instructions	69
Vaisala Service Centers.....	70
 CHAPTER 14	
TECHNICAL SPECIFICATIONS.....	71
Probes HMP75, HMP76 and HMP77.....	71
Measured Variables	71
Relative Humidity	71
Temperature.....	72
Calculated Variables	72

Typical Ranges.....	72
Accuracies of Calculated Variables.....	73
Accuracy of Dewpoint Temperature °C.....	73
Accuracy of Mixing Ratio g/kg.....	73
Accuracy of Wet Bulb Temperature °C.....	74
Accuracy of Absolute Humidity g/m ³	74
General	74
MI70 Indicator.....	75
Indicator General.....	75
Battery Pack.....	76
General about Vaisala Hand-Held Humidity and Temperature Meter HM70	76
Electromagnetic Compatibility.....	76
Accessories.....	77
Dimensions in mm (inches).....	78

CHAPTER 1

GENERAL INFORMATION

About This Manual

This manual provides information for operating, and maintaining the Vaisala HUMICAP[®] Hand-Held Humidity and Temperature Meter HM70.

Version Information

Table 1 Manual Revisions

Manual Code	Description
M210297EN-A	May 2002 - First release
M210297EN-B	April 2004
M210297EN-C	January 2005
M210297EN-D	April 2006
M210297EN-E	May 2007 - Sensor types updated to HUMICAP [®] 180R and HUMICAP [®] 180RC
M210297EN-F	October 2007 - USB connectivity option added, new display languages (Chinese, Japanese, Russian) added.

General Safety Considerations

Throughout the manual, important safety considerations are highlighted as follows:

WARNING

Warning alerts you to a potential hazard. If you do not read and follow instructions very carefully at this point, there is a risk of injury or even death.

CAUTION Caution warns you of a potential hazard. If you do not read and follow instructions carefully at this point, the product could be damaged or important data could be lost.

NOTE Note highlights important information on using the product.

Recycling

 Recycle all applicable material.

 Dispose of batteries and the unit according to statutory regulations. Do not dispose of with regular household refuse.

Warranty

Vaisala hereby represents and warrants all Products manufactured by Vaisala and sold hereunder to be free from defects in workmanship or material during a period of twelve (12) months from the date of delivery save for products for which a special warranty is given. If any Product proves however to be defective in workmanship or material within the period herein provided Vaisala undertakes to the exclusion of any other remedy to repair or at its own option replace the defective Product or part thereof free of charge and otherwise on the same conditions as for the original Product or part without extension to original warranty time. Defective parts replaced in accordance with this clause shall be placed at the disposal of Vaisala.

Vaisala also warrants the quality of all repair and service works performed by its employees to products sold by it. In case the repair or service works should appear inadequate or faulty and should this cause malfunction or nonfunction of the product to which the service was performed Vaisala shall at its free option either repair or have repaired or replace the product in question. The working hours used by employees of Vaisala for such repair or replacement shall be free of charge to the client. This service warranty shall be valid for a period of six (6) months from the date the service measures were completed.

This warranty is however subject to following conditions:

- a) A substantiated written claim as to any alleged defects shall have been received by Vaisala within thirty (30) days after the defect or fault became known or occurred, and
- b) The allegedly defective Product or part shall, should Vaisala so require, be sent to the works of Vaisala or to such other place as Vaisala may indicate in writing, freight and insurance prepaid and properly packed and labelled, unless Vaisala agrees to inspect and repair the Product or replace it on site.

This warranty does not however apply when the defect has been caused through

- a) normal wear and tear or accident;
- b) misuse or other unsuitable or unauthorized use of the Product or negligence or error in storing, maintaining or in handling the Product or any equipment thereof;
- c) wrong installation or assembly or failure to service the Product or otherwise follow Vaisala's service instructions including any repairs or installation or assembly or service made by unauthorized personnel not approved by Vaisala or replacements with parts not manufactured or supplied by Vaisala;
- d) modifications or changes of the Product as well as any adding to it without Vaisala's prior authorization;
- e) other factors depending on the Customer or a third party.

Notwithstanding the aforesaid Vaisala's liability under this clause shall not apply to any defects arising out of materials, designs or instructions provided by the Customer.

This warranty is expressly in lieu of and excludes all other conditions, warranties and liabilities, express or implied, whether under law, statute or otherwise, including without limitation any implied warranties of merchantability or of fitness for a particular purpose and all other obligations and liabilities of Vaisala or its representatives with respect to any defect or deficiency applicable to or resulting directly or indirectly from the Products supplied hereunder, which obligations and liabilities are hereby expressly cancelled and waived. Vaisala's liability shall under no circumstances exceed the invoice price of any Product for which a warranty claim is made, nor shall Vaisala in any circumstances be liable for lost profits or other consequential loss whether direct or indirect or for special damages.

This page intentionally left blank.

CHAPTER 2

PRODUCT DESCRIPTION

Vaisala HUMICAP[®] Hand-Held Temperature and Humidity Meter HM70

HM70 consists of two main units: MI70 indicator and HMP75/HMP76/HMP77 probe. HM70 Hand-held humidity meter incorporates Vaisala's advanced HUMICAP[®] technology which enables reliable and high performance humidity measurement. HM70 is available with an optional, ready-to-use Microsoft Windows[®] software, which allows an easy way to handle measurement data using a serial line or a USB instrument cable.

Vaisala HM70 is delivered with a factory calibration certificate.

Display Parameters

- **RH** relative humidity (% RH)
- **T** temperature (°C/°F)
- **T_{d/f}** : dewpoint/frostpoint¹⁾ temperature (°C/°F)
- **T_d** : dewpoint temperature²⁾ (°C/°F)
- **a** : absolute humidity (g/m³/ gr/ft³)
- **x** : mixing ratio (g/kg / gr/lb)
- **T_w**: wetbulb temperature (°C/°F)
- **H₂O**: humid air volume/ dry air volume (ppm)
- **pw**: water vapour pressure (hPa/ lb/in²)
- **pws**: saturation water vapour pressure(hPa/ lb/in²)
- **h** : enthalpy (kJ/kg / Btu/lb)
- **a_w** : water activity

¹⁾ T_{d/f} shows dewpoint temperature above the freezing point (0°C/32 °F) and frostpoint temperature T_f (dewpoint over ice) below the freezing point.

2) T_d shows dewpoint over water throughout the entire measurement range.

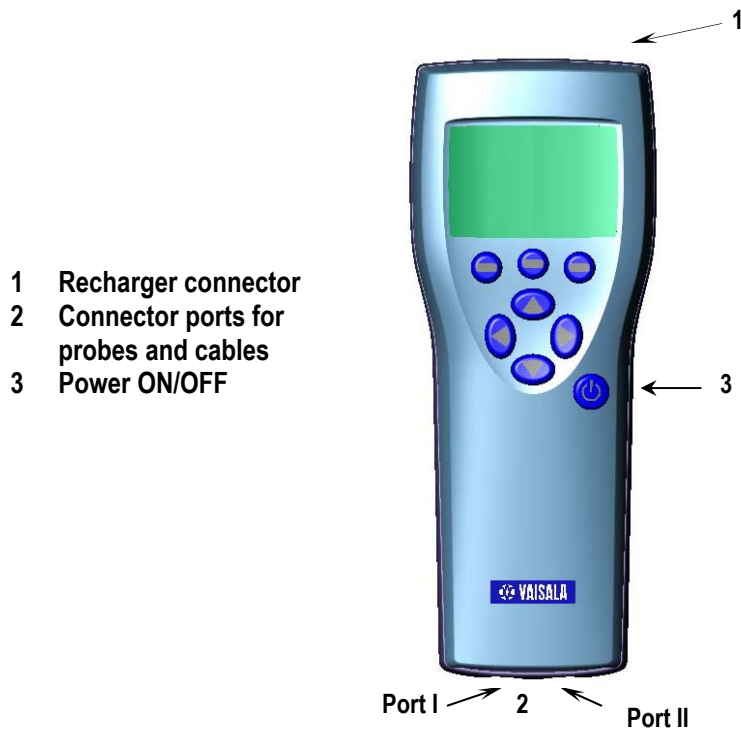
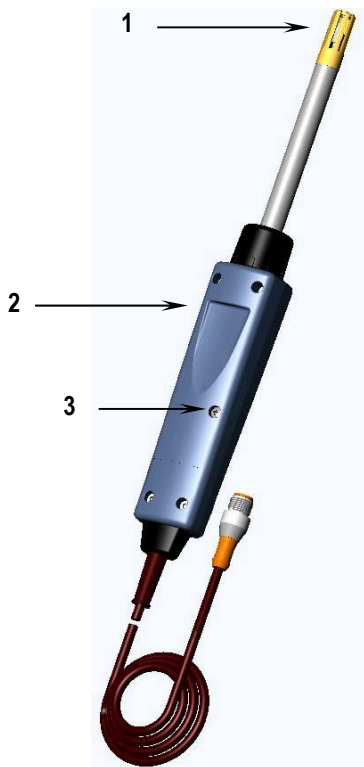

Figure 1 MI70 indicator

- 1 Probe filter
- 2 Probe HMP75/76/77
- 3 Calibration button under the screw



HMP75 PROBE
 Basic probe for relative humidity and temperature measurement
 Preheat and chemical purge options available (HMP75B).

HMP76 PROBE
 Rugged probe with a long stainless steel shaft. Preheat and chemical purge options available (HMP76B).

HMP77 PROBE
 Cable probe for industrial processes up to 180 °C. Preheat and chemical purge options available (HMP77B).

Figure 2 HMP75, HMP76, and HMP77 probes

This page intentionally left blank.















CHAPTER 3

PREPARATIONS BEFORE USE

Installing and Recharging the Batteries

1. If you are using alkaline batteries, remove the back plate of the indicator and insert the batteries. If the HM70 is ordered with a rechargeable battery pack, it is already in place as shipped from the factory.
2. Recharge the battery pack as follows: Plug in the recharger connector to the base of the indicator and connect the recharger to a wall socket. A battery symbol in the corner of the display starts to roll.
 - It is not recommended to use HM70 during the first recharging. After the first charge cycle is complete, you can use the HM70 while recharging.
 - The duration of recharging depends on the charge level of the battery pack. 4 hours is a typical recharging time. The recommended first charging time is 6 hours.
3. When the battery symbol stops rolling, the battery is fully recharged. Disconnect the recharger.

Turning ON the Device

1. Connect the probe to the either of the base connectors of the indicator.
2. Press the  button to turn on the device.
3. Select the language by using the   buttons. Confirm by pressing  **SELECT**. You can select the language later as well, see page 24.
4. To change the date, select **Date** and press  **SET**. Change the date by using any of the     buttons. To confirm the date, press  **OK**. The default date presentation format is: **year-month-date**. If you want to change the format, see page 26.
5. To change the time, select **Time** and press  **SET**. Change the time by using arrow buttons. To confirm the time, press  **OK**. The default time presentation format is 24-hour clock. If you want to use 12-hour clock, select **12-hour clock**, and press  **ON**.
6. Press  **EXIT**. To check and change the pressure setting, select **YES**. Otherwise select **NO** to enter the basic display.

CHAPTER 4

TAKING MEASUREMENTS

If you are starting the HM70 for the first time, see Chapter 3 *Preparations Before Use* first.

To take measurements with the HM70, follow the instructions below:

1. Connect the probe to MI70-indicator.
2. Press  **POWER ON/OFF** button.
3. If you have a chemical purge option in your probe (HM70 series probe versions B), remember to carry out chemical purge regularly, see page 34.
4. In case there is a risk for condensation, use the optional preheat (HM70 series probe versions B) when installing the probe, see page 36.
5. Install the probe to the measuring position. If measuring in pressurized processes, see the instructions on page 21.
6. Before measurements, ensure that the air pressure setting of HM70 is correct. See page 21.
7. The basic display opens. Let the reading stabilize.

CAUTION

If you need to disconnect the probe from the indicator, first press  **POWER ON/OFF** button to turn the indicator OFF. This ensures that all settings and data are saved properly.

Beware of Temperature Differences

In humidity measurement and especially in calibration it is essential that temperature of the probe and measuring environment is the same. Even a small difference in temperature between the environment and the probe causes an error. As the curve below shows, if the temperature is +20 °C and the relative humidity 100 %RH, a difference of ± 1 °C between the environment and the probe causes an error of ± 6 %RH. When the humidity is 90 %RH, the corresponding error is ± 5.4 %RH.

A temperature difference of a few degrees can also cause water to condense on the sensor surface. HUMICAP[®] sensor starts to function normally as soon as the water has evaporated. If the condensed water is contaminated, the life span of the probe may shorten and calibration may change. See also information about sensor preheat, page 36.

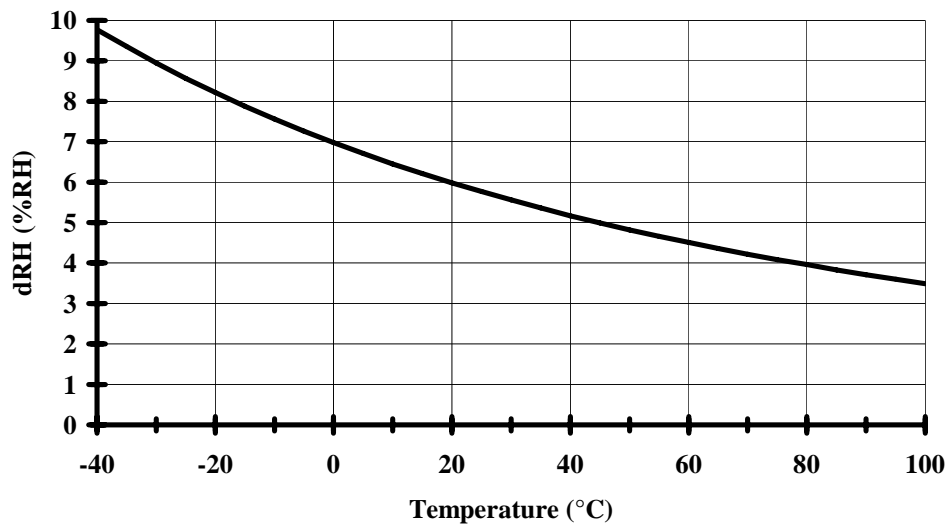

Figure 3 Measurement error at 100 %RH with 1 °C difference between the ambient and sensor temperature

CHAPTER 5

BUTTONS, DISPLAYS AND MENUS

Buttons and Navigation

To open a menu view
1. Press an arrow button
2. Press this shortcut button

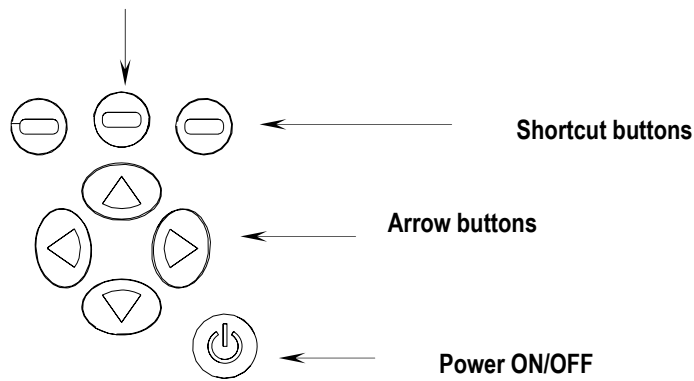





Figure 4 MI70 buttons

-  Press down the **POWER ON/OFF** button until the indicator turns on/off.
-  Press the **SHORTCUT** buttons to activate the function shown above the button.
-  Press any of the **ARROW** buttons to open the **MENUS**. In the **MENUS** you can navigate with **ARROW** buttons.

Basic Display

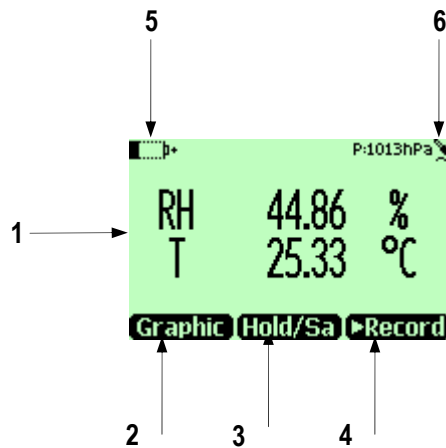

Figure 5 MI70 basic display

1. Selected quantities. Up to three of the quantities can be selected at a time.
 - **RH** relative humidity (% RH)
 - **T** temperature (°C/ °F)
 - **T_{d/f}** : dewpoint/frostpoint¹ temperature (°C/ °F)
 - **T_d** : dewpoint temperature²⁾ (°C/ °F)
 - **a** : absolute humidity (g/m³/ gr/ft³)
 - **x** : mixing ratio (g/kg / gr/lb)
 - **T_w**: wetbulb temperature (°C/ °F)
 - **H₂O**: humid air volume/ dry air volume (ppm)
 - **pw**: water vapour pressure (hPa/ lb/in²)
 - **pws**: saturation water vapour pressure(hPa/ lb/in²)
 - **h** : enthalpy (kJ/kg / Btu/lb)
 - **a_w** : water activity
2. Shortcut button **Graphic**¹ changes display into curve mode
3. Shortcut button **Hold/Sa**¹ freezes display and you may save the reading into the memory.
4. Shortcut button **▶Record**¹ takes you to the **Recording/Viewing** menu.
5. State of battery.
6. Pressure setting.

¹**Graphic, Hold/Sa** and **Record** -functions above the shortcut buttons are set in the factory. You can change them to refer other functions (see page 25).

Graphical Display

Graphical display shows you the measurements in a form of curve. From the curve you can examine the data trend and history of the last minutes. Graphical display shows firstly the curve of the uppermost quantity shown in a basic display.

1. In basic display, press **Graphic** or (alternatively open the **MENU**, select **Display**, select **Graphic history**)
2. Graphical display opens. More information on page 23 **Graphic history**.
3. Press **BACK** to return to the basic display.

Menus

In the menu you can change settings and select the functions.

1. Open the main menu by pressing any of the **OPEN** buttons.
2. Press **OPEN** within 5 seconds. The basic display returns if you do not open the **MENU** shortly. If this happens, begin with the item 1 again.
3. Move in the menu by using **UP**/**DOWN** buttons.
4. Select the item with **RIGHT** button.
5. Press **LEFT** to return to the earlier level.
6. **EXIT** returns back to normal operation.



Main menu



Display menu

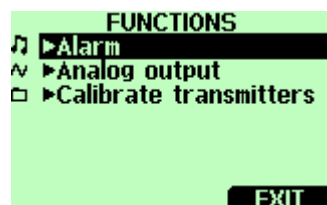

Functions menu



Recording/Viewing menu

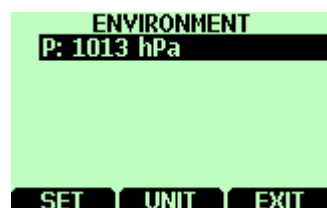

Environment menu



Settings menu

This page intentionally left blank.

CHAPTER 6

SETTINGS

Pressure Setting

When measuring in pressurized environments, the actual process pressure value must be given to the HM70. The pressure can be given in the following units:

hPa: Absolute pressure given in the unit of hPa.

barg: Gauge pressure given in the unit of bar. Indicates the pressure difference between normal atmospheric pressure and the actual process pressure.

bara: Absolute process pressure given in the unit of bar.

psia: Absolute pressure given in the unit of psi.

Follow the instructions below:



1. Open the **MENU**; press $\text{▶} \ominus \text{▶}$ **OPEN**
2. Select **▶ENVIRONMENT** with $\text{▲} \text{▼}$ and press ▶ .
3. Press \ominus **UNIT** to change the pressure unit. Default unit is hPa.
4. Press \ominus **SET** to set the ambient pressure value.
5. Set the pressure value by using $\text{▲} \text{▼} \text{▶} \text{◀}$ buttons. Press \ominus **+/-** to change the sign of the pressure value. Press \ominus **OK** to save the value.
6. Press \ominus **EXIT** to return to the basic display.

Display Settings



Quantities and Units

All the quantities and units are shown in page 9.

1. Open the **MENU**; press \blacktriangleright \ominus **OPEN**.
2. Select \blacktriangleright **Display**, press \blacktriangleright .
3. Select \blacktriangleright **Quantities and units**, press \blacktriangleright .
4. To select a quantity, move on the quantity you want by using the arrow buttons, press \ominus **SELECT**.
5. To change the unit, move on the quantity you want by using the arrow buttons, then press \ominus **UNIT**.
6. To hide a quantity, move on the quantity you want to hide by using the arrow buttons, then press \ominus **HIDE**.
7. Press \ominus **EXIT** to return to the basic display.
8. If asked, press \ominus **YES**, if you want to check environment settings, otherwise press \ominus **NO**.













Rounding

You can turn on the decimal display by using the **Rounding** function. The default setting is rounding off.

1. Open the **MENU**: press \blacktriangleright \ominus **OPEN**
2. Select the \blacktriangleright **Display**, press \blacktriangleright
3. Select **Rounding**.
4. Press \ominus **ON** to have rounding on. Press \ominus **OFF** to deactivate rounding (two decimal display).
5. Press \ominus **EXIT** to return to the basic display.





Hold/Save Display

Hold/Save function enables you to freeze a certain display reading. This reading can be saved into the memory.

1. Open **MENU**: press   **OPEN**.
2. Select **►Display**, press .
3. Select **Hold/Save display**.
4. Press  **HOLD** to freeze the display. The frozen measurement data is displayed.
5. Press  **SAVE** to save the reading and  **CANCEL** to return to the menu.
6. You can save several readings with **HOLD-SAVE** function. The data points are identified on the basis of the saving date and time. All the individual readings (data points) are stored in a same file marked with . The file remains in the indicator memory even if the indicator is switched OFF.
7. To view the saved readings, press  **►Record**, select **►View recorded data**, press .
8. Select the file marked with , press . Now you can see the saved data readings. Press  **TIMES** to see the recording timestamps.
9. Press  **EXIT** to return to the basic display.

Graphic History

Graphic history shows the data curve of the last hour. To see longer graphs, use the data recording function to save the data and then view it as a graph.

1. Open the **MENU**: press   **OPEN**.
2. Select **►Display**, press .
3. Select **Graphic history**, press  **SHOW** to have a graphical history display.
4. To get the statistical info on the graph area (minimum, maximum and mean values), press  **INFO**.

5. To get the curve of the other selected quantities, press \ominus NEXT. To get the curves of the all quantities, press \ominus NEXT until text ALL is shown instead of NEXT. Then press \ominus ALL.
6. To zoom in the curve, press the arrow button \triangle . To zoom out, press the button ∇ . To move the curve in horizontal directions, press the buttons \triangleright \triangleleft .
7. Press \ominus BACK and EXIT to return to the basic display.

User Interface



Selecting Language







You can select any of the following languages as a user interface language: English, German, French, Finnish, Spanish, Swedish, Chinese, Russian or Japanese.

1. Open the MENU: press \triangleright \ominus OPEN.
2. Select \triangleright Settings, press \triangleright .
3. Select \triangleright User interface, press \triangleright .
4. Select Language, press \ominus SET.
5. Select the language you want, press \ominus SELECT.
6. Press \ominus EXIT to return to the basic display.

If you accidentally select a wrong language, first go back to the basic display by pressing rightmost \ominus key as many times as required, then go to the language selection menu by pressing: \triangleright , middle \ominus key \triangle , \triangleright , \triangleright , middle \ominus key.







Automatic Power OFF

As shipped from factory, HM70 has a default setting which turns the power off automatically after 15 minutes of inactivity. This is to conserve the battery. In case you want to change the inactivity time setting to 60 minutes or turn off the automatic power off function, follow the instructions.

1. Open the **MENU**: press   **OPEN**.
2. Select **Settings**, press .
3. Select **User interface**, press .
4. Select **Auto power off**, press  **SET**.
5. Select the choice you want, press  **SELECT**.
6. Press  **EXIT** to return to the basic display.

Changing Shortcut Keys

As a default, the three shortcut keys refer to the functions **Graphic**, **Hold/Save** and **Record**. If needed, a shortcut for the functions can be changed to correspond to your needs.

1. Open the **MENU**: press   **OPEN**.
2. Select **Settings**, press .
3. Select **User Interface**, press .
4. Select **Program shortcut keys**, press  **START**.
5. Press the shortcut key you want to change, e.g. **Hold/Save**.
6. If you want to replace **Hold/Save** with Chemical purge-function (as an example), select **Chemical Purge** by using arrow buttons (**Functions**) **Chemical Purge**, press  **SELECT**. Answer **YES** to confirm your selection, otherwise answer **NO** and continue from item 4.
7. Press  **EXIT** to return to the basic display.

Hold/Save -shortcut key replaced
by Chemical purge -shortcut key

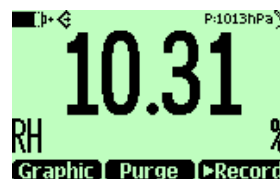

Button Click and Backlight on Button Press

1. Open the **MENU**: press **OPEN**.
2. Select **▶Settings**, press .
3. Select **User interface**, press .
4. To turn OFF or ON sound effect while pressing the buttons, select **Key Click** and press **ON/OFF**.
5. To turn OFF and ON backlight while pressing the buttons, select **Backlight on key press** **ON/OFF**.
6. Press **EXIT** to return to the basic display.

Setting Date and Time

To have correct date and time in recorded data files, set the date and time according to the following instructions.

1. Open the **MENU**: press **OPEN**.
2. Select **▶Setting**, press .
3. Select **▶Date and time**, press .
4. To change the date, select **Date** and press **SET**. Change the date by using arrow buttons. To confirm the date, press **OK**. The default date presentation format is *year-month-date*, e.g.2002-06-05. If you want to change the format, select **Date format: Y-M-D**, press **SET** , select either **D.M.Y** or **M/D/Y**, press **SELECT** .
5. To change the time, select **Time** and press **SET**. Change the time by using arrow buttons. To confirm the time, press **OK**. The default time presentation format is 24-hour clock. If you want to change the format, select **12-hour clock**, press **ON/OFF**.
6. Press **EXIT**.

Device Information

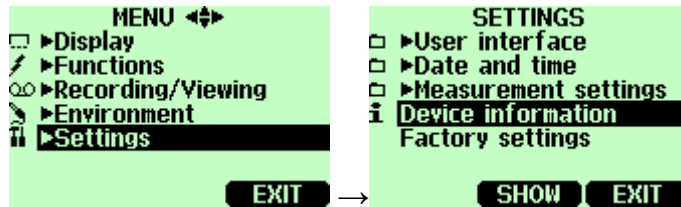

The basic information about the indicator and the probe is found as follows:

1. Open the **MENU**: press \triangleright \ominus **OPEN**
2. Select **Settings**, press \triangleright .
3. Select **Device information**, press \ominus **SHOW**.
4. The first display gives the information on the MI70 indicator. Press \ominus **MORE** to get the information on the probe. Press \ominus **OK** and \ominus **EXIT** to return to the basic display.

MI70 indicator information



Probe type information



Reverting to Factory Settings

You can revert to factory settings to clear all changed settings and recorded data on the indicator. Reverting to factory settings does not affect probe calibration.

1. Open the **MENU**: press \triangleright \ominus **OPEN**.
2. Select **Settings**, press \triangleright .
3. Select **Factory settings**, press \ominus **REVERT**. Press \ominus **YES** to confirm the reverting.
4. The power turns off automatically. When switching on again, the factory settings are reverted. After reverting to the factory settings, you must set the language, date and time again. See Chapter 3.

This page intentionally left blank.

CHAPTER 7

RECORDING DATA

Recording

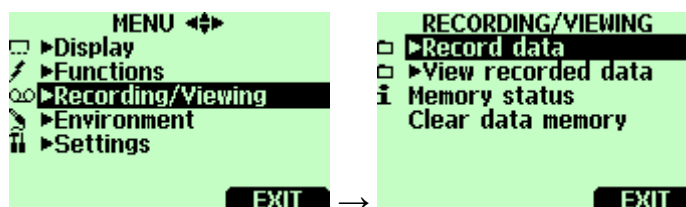

You can record measurement data and view the recorded data on the display.

1. Press the shortcut $\ominus \blacktriangleright$ Record, (alternatively open the MENU, select \blacktriangleright Recording/Viewing).
2. Select \blacktriangleright Record data, press \odot .
3. To change interval, select Interval, press \ominus SET.
4. Select the measurement interval with arrow buttons. Measurement intervals and the maximum recording times are shown in the table below.

Recording interval	Maximum recording time (memory full)		
	1 quantity	2 quantities	3 quantities
1 s	45 min	22 min	15 min
5 s	3 h	113 min	75 min
15 s	11 h	5 h	3 h
30 s	22 h	11 h	7 h
1 min	45 h	22 h	15 h
5 min	9 days	4 days	3 days
15 min	28 days	14 days	9 days
30 min	56 days	28 days	18 days
1 h	113 days	56 days	37 days
3 h	339 days	169 days	112 days
12 h	1359 days	678 days	451 days

5. Press \ominus **SELECT**.
6. To set the recording duration, select **Duration**, press \ominus **SET**.
7. Select the recording duration (1 min, 5 min, 15 min, 30 min, 1 h, 3 h, 12 h, 24 h, 7 d, 30 d, memory full) with arrow buttons and press \ominus **SELECT**.
8. Start recording: select **Start/Stop recording**, press \ominus **START**. If you chose 'Memory full', you see the maximum recording time on the display. You can also delete files in order to empty the memory. Press \ominus **START** again to accept maximum recording time.
9. You can switch the HM70 off during recording to save battery. Display message tells you that recording continues undisturbed even when power is off. If the indicator is switched off during recording, the progress bar  is shown on the display every 10 seconds (all the time, if charger is connected). This bar shows the amount of recorded data.

CAUTION

Do not disconnect the probe when the data recording is on, even if the indicator is off. This may cause loss of recorded data.

Stopping Recording

1. To stop recording press \ominus **▶Record**, select **▶Record data** and press \odot , select **Start/Stop recording** and press \ominus **STOP**.
2. Now you can go and see the recorded file by selecting \ominus **SHOW**.

You can save individual measurement data points with **Hold/Save** function described in page 23.

Viewing Recorded Data

1. Open the **MENU**: press \odot \ominus **OPEN**.
2. Select **▶Recording/Viewing**, press \odot .
3. Select **▶View recorded data**, press \odot .

4. Select the file you want to view, press \odot . The files are identified according to the starting date and time of recording.
5. Press \ominus **GRAPH** to get the graphical view, press \ominus **TIMES** to get the recording timestamps (press \ominus **VALUES** to go back the recorded values).
6. Press \ominus **EXIT** to return to the basic display.

Checking Memory Status

You can check how much there is free space in the memory.

1. Open the **MENU**: press \odot \ominus **OPEN** .
2. Select **Recording/Viewing**, press \odot .
3. Select **Memory status**, press \ominus **SHOW** to see the amount of memory in use and the estimated free space.
4. To return to the basic display, press \ominus **OK** and \ominus **EXIT**.

Note that the estimate of the free space is calculated for current number of active quantities. If you change the displayed quantities, the estimate is different.

Deleting All Recorded Files

The data memory can be cleared as follows:

1. Open the **MENU**: press \odot \ominus **OPEN**.
2. Select **Recording/Viewing**, press \odot .
3. Select **Clear data memory**, press \ominus **CLEAR**. Press \ominus **YES** to confirm deletion of all recorded data files.
4. To return to the basic display, press \ominus **EXIT**.

MI70 Link Program for Transferring Recorded Data to PC

The recorded data can be transferred to a PC by using MI70 Link program.

MI70 Link program can be ordered from Vaisala, see the list of accessories on page 77. You can examine the recorded data easily in Windows[®] environment and transfer it further to a spreadsheet program (such as Microsoft[®] Excel) to be modified.

MI70 Link Program for Real-Time PC Monitoring

You can monitor HM70 readings directly with a PC by using MI70 Link program. MI70 Link program can be ordered from Vaisala, see the list of accessories on page 77.

Together with the USB instrument cable (optional accessory 219687) or the serial connection cable it is easy to transfer logged and real time measurement data from the HM70 to a PC.

When using the USB cable consider the following: the MI70 Link program contains the driver needed for the USB connection. For the system requirements and installation, see the back of the installation CD. Follow the installation instructions on the CD. Check that the USB cable is not connected. The MI70 Link Setup Wizard will install Vaisala MI70 Link on your computer. Installing the USB instrument driver can take a few minutes. After the installation is finished, connect the USB cable to the USB port on your PC. Windows will detect the new device, and use the driver automatically.

You can now start monitoring the HM70 readings in real time with a PC using the MI70 Link program. In case the MI70 Link cannot find the instrument, check the following:

- the HM70 is switched on
- the USB instrument cable/serial connection cable is properly connected to the USB/serial port of your PC
- another application has not reserved the connection

CHAPTER 8

OTHER FUNCTIONS

Setting Alarm Levels

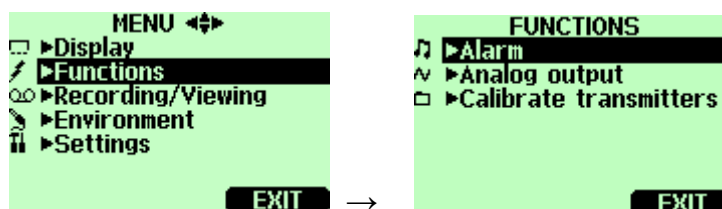

HM70 is alarming by beeping and blinking the backlight. The alarm turns on when the measured value is not between the alarm limits (permissible area). Alarm level(s) can be set for only one quantity at a time. Set the alarm levels as follows:

1. Open the **MENU**: press \triangleright \ominus **OPEN**.
2. Select \triangleright **Functions**, press \triangleright .
3. Select \triangleright **Alarm**, press \triangleright .
4. Select **Quantity** and press \ominus **SET** to choose a quantity.
5. Select quantity, press \ominus **SELECT**. (Only one quantity can be chosen at a time. Only active quantities can be selected. To change the active quantities, go to **MENU** \triangleright **Display** \triangleright **Quantities and units**).
6. Select the first limit, press \ominus **SET** (if the alarm function is ON, take it OFF). Set the alarm level by using arrow buttons. Press \ominus **+/-** button to choose the sign of the alarm level. Press \ominus **OK** to save the setting.
7. Select the second limit, then follow instructions in item 6. The alarm will go off when the upper limit is exceeded or when lower limit is gone below.

If you have only one limit, e.g. if you want to detect if the humidity is rising above 50 % RH, set the upper limit to 50 %

RH and the lower limit so low that it never will be reached (for example 0 % RH). Thus, the HM70 will alert when RH rises above 50 % RH.

8. Select **Alarm ON/OFF**, press \ominus **ON** to activate the alarm and return back to the basic display.
9. A note picture sign 🔔 appears on the upper left corner.
10. When the alarm level is reached, you can stop alarming by pressing \ominus **OK**. To reactivate the alarm function, answer \ominus **YES**. To stop the alarm function completely, answer \ominus **NO**.

NOTE

The alarm is not in function when the device is turned off. Remember to turn off the automatic power off, see page 25.

Chemical Purge (Optional)



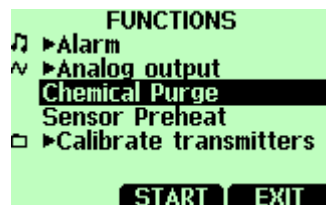

Chemical purge is an optional feature of the HM70 series humidity probes (B-version probes). In some specific applications the sensor gain may decrease gradually due to an interference caused by some particular chemical present in the ambient. The sensor polymer absorbs the interfering chemical; this reduces the polymer's ability to absorb water molecules and so decreases the sensor sensitivity. In chemical purge the interfering chemical is evaporated by heating the humidity sensor to a temperature of +160 °C for 2 minutes.

For the most applications it will be sufficient to perform the chemical purge once a week. For applications where HM70 is subject to high concentrations of chemicals, chemical purge should be performed more frequently, in extreme cases before each measurement.

Turning Chemical Purge ON



The following applies only with humidity probes HMP75B, HMP76B and HMP77B:

1. Open the **MENU**: press   **OPEN**.
2. Select **►Functions**, press .
3. Select **Chemical Purge**, press  **START**.
4. Confirm the starting by pressing **YES**. Chemical purge takes up to 6 minutes. During that time there are no readings on a display. A message display appears once in 15 seconds and it tells you the time required to complete the chemical purge. The chemical purge symbol  **Purge** is shown on upper left corner.
5. When the chemical purge is done the basic display with readings returns.
6. Stabilization of temperature reading can take a few minutes.

You can make a shortcut to the chemical purge function by setting one shortcut key to refer Chemical Purge function, see page 25.

Sensor Preheat (Optional)

Sensor preheat is an optional feature of the HM70 series humidity probes (B-version probes).

In some measurement applications, unwanted dew formation makes humidity measurement difficult or even impossible. High humidity combined with rapidly changing outdoor temperature can condense the water vapour in the air onto the sensor. Until this dew evaporates or dries, it is impossible to obtain a true reading. In sensor preheat the sensor is heated to a temperature level of approximately +100 °C for up to 4 minutes. This is to prevent possible condensate from the sensor.

When setting the probe from outdoor conditions into warm and humid conditions there can be large temperature difference between the probe and external environment. In such a conditions turn on the sensor preheat immediately before installing the probe to prevent condensation forming on the probe.

Figure below shows how response time can be dramatically shortened and water condensation on the sensor avoided when using sensor preheat.

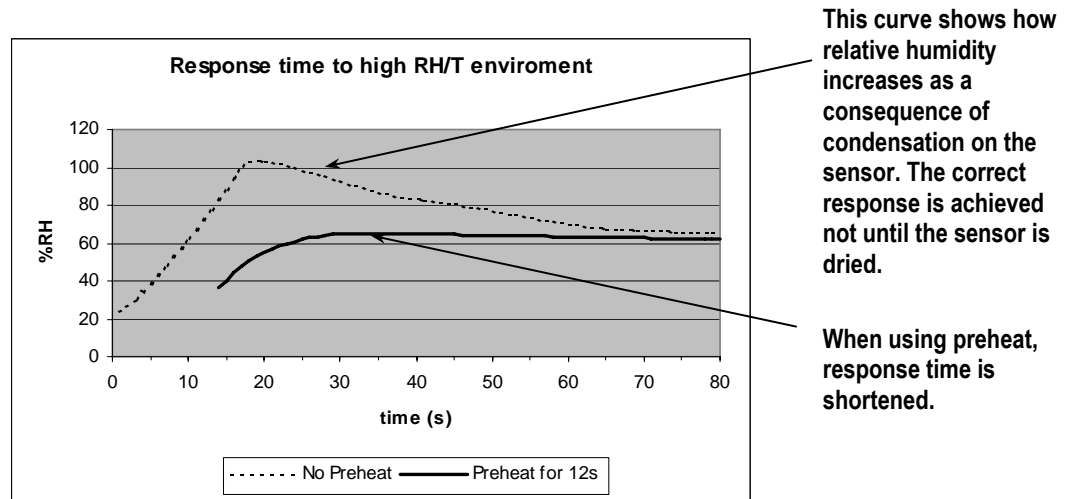
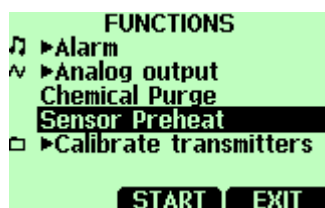







Figure 6 Response time to high RH/T environment

Turning Sensor Preheat ON/OFF



The following applies only with humidity probes HMP75B, HMP76B and HMP77B:

1. Open the **MENU**: press   **OPEN**.
2. Select **►Functions**, press .
3. Select **Sensor Preheat**, press  **START**. Confirm the starting by pressing **YES**.
4. Insert the probe to the process.
5. When sensor preheat is done, a display message tells that operation is completed and the basic display with readings returns.

Sensor preheat is taking about 4 minutes at maximum. During that time there are no readings on a display. A message display appears once in 15 seconds and it tells you the time required to complete the sensor preheat. Sensor preheat symbol  is shown on upper left corner. Stabilization of the temperature can take a few minutes.

You can make a shortcut to the sensor preheat function by setting one shortcut key to refer sensor preheat function, see page 25.

This page intentionally left blank.

CHAPTER 9

CALIBRATION AND ADJUSTMENT OF TRANSMITTERS

HM70 in Checking and Adjusting

The following transmitters can be calibrated by using HM70: HMDW 60/70, HMW 61/71, HMD/W 20/30, HMP130, HMP230/240 series, HMT320/330 series, HMM210 series and DMW19 transmitter.

When calibrating in the field, check and adjust a fixed transmitter's reading against a calibrated reference probe on the HM70.

One or two point calibrations can be done to industrial transmitters and modules (HMP230/240 series, HMT320/330 series, HMM210 modules) by using a MI70 indicator and Vaisala's humidity calibrator HMK15.

Calibration Cables

For calibration and adjustment connect HM70 to fixed transmitter by using one of the following connection cables:



- HMA6070-cable for HMD/W 60/70 and HMW 61/71 transmitters
- HMA2030-cable for HMD/W 20/30 and HMP130 transmitters
- 27159ZZ-cable for HMP230/240 series transmitters and HMM210 series modules.
- 211339-cable for HMT320/330 series transmitters
- 211917ZZ-cable for DMW19 transmitter.







Figure 7 Connectors for connection cables

Calibration and Adjustment of HMD/W 60/70, HMD/W 20/30 and HMP130 Series Transmitters

For checking and adjusting HM60/70 series and HM20/30/130 series transmitters you need a MI70 and a HMP70 calibrated reference probe and a connection cable. Only relative humidity channel of these transmitters can be checked.

1. Connect the end of the HMA6070 (connection cable for HM60/70-series) or HMA2030 (connection cable for HM20/30-series) cable to either of the HM70's connector port located on the bottom of the indicator, see Figure 7 on page 40.
2. Connect the other end of the HMA6070 or HM20/30/130-cable to the **RH TEST** connector (or **TEST** connector) of the transmitter's motherboard.
3. Turn on MI70 indicator.
4. **This concerns ONLY calibration of HM60/70-series:** If a transmitter has voltage output, select the RH input scale setting 0... 20 mA. If a transmitter has current output, set the indicator's default setting to correspond the transmitter's signal (0... 20 mA/4...20 mA) as follows:
 - Open the **MENU**: press   **OPEN**.

- Select ►Settings, press 
 - Select ►Measurement settings, press 
 - Select RH scale: 4...20 mA or 0...20 mA, press  ON
 - To return to the basic display, press  EXIT
5. Now the reading of the transmitter is shown on the first or middle row of the display, depending on the connector port to which the calibration cable is connected. Value of the port I is shown on the upper row of the display and the value of the port II on the lower row of the display. Difference of the readings is shown in the lowest row.

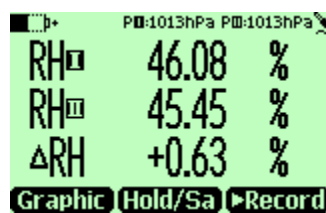

6. Ensure that the probes are located in the same conditions. You can have an optional probe holder for the HMP76 probe to attach the probe next to the probe of HMD60/70 or HMD20/30 (order code for the probe holder: HM36915).
7. Wait until the readings have stabilized (can take up to 20 minutes). If the difference between the humidity readings is less than 2 % RH, there is no immediate need for adjustment.
8. Adjust the transmitters reading to correspond the HM70 reference probe by turning the small screw on the modules on the transmitter's mother board marked with **RH offset/ RH gain**. If the RH reading is < 65 %, turn the **RH offset** screw and if the RH reading is >65 %, turn the **RH gain** screw. Turning to the clockwise direction increases the reading, turning to opposite direction decreases the reading.
- Do not breathe towards the transmitter probes when adjusting the reading.
9. When the transmitter reading is equal with the HM70 reference probe's reading, adjustment is done.
10. Switch off HM70 and detach the cable from the transmitter and the HM70 indicator.

Calibration and Adjustment of HMT100 Series Transmitters

You can check and adjust the HMT100 relative humidity measurement with Vaisala HM70 Hand-Held Humidity and Temperature meter. A HM70-connection cable is needed, Vaisala order code: 211339.

There are four types of adjustments available: field checking and adjustment using a calibrated reference probe, one-point adjustment using a calibrator, two-point adjustment using a calibrator and LiCl-NaCl adjustment.

Follow the 7 first steps and continue according to the chosen adjustment method:

1. Connect the 211339 HM70-connection cable to the **SERVICE PORT** connector on the HMT100 motherboard.
2. Connect the other end of the connection cable to either of the HM70's connector ports located on the bottom of the indicator.
3. Turn on both devices (or just the HM70 if HMT100 is on continuously).
4. The reading of the transmitter is shown on the top or middle row of the indicator display, depending on which connector port the connection cable is connected to.
5. Press the **ADJ** button on the HMT100 motherboard to open the adjustment mode. The indicator led on the HMT100 motherboard starts flashing. From now on the adjustment is carried out using the MI70 indicator.
6. Press **OK** to start adjustment.
7. Check the environment settings if needed. Otherwise press **NO**. Continue according to the directions of the desired adjustment method.

Field Checking and Adjustment Using a Calibrated Reference Probe

Follow steps 1 to 7 above and continue as follows:

8. Check that the probes are located in equal conditions and wait until the readings have stabilized (may take 30 minutes or

more). If you are near the probes, do not breath in their direction.

9. Press **ADJUST** to continue adjusting.
10. Choose **To same as RH_{III}** from the MI70 adjustment menu, press **SELECT** (MI70 automatically recognizes which port the HMP70-series probe is connected to).
11. Confirm the adjustment by pressing **YES**.
12. The adjustment is done. Press **BACK** and **EXIT** to return to the basic display.
13. Turn off the MI70 and detach the connection cable.

One-Point Adjustment Using a Calibrator

When adjusting the transmitter in only one reference condition, please take care that the reference condition represents the measuring environment. MI70 indicator is used now only as a terminal for visualizing and setting the transmitter's RH reading.

Follow steps 1 to 7 on page 42 and continue as follows:

8. Remove the filter from the transmitter's probe and insert the probe into the reference condition.
9. Press **ADJUST** to continue adjusting.
10. Choose **1-point adjustment** from the MI70 adjustment menu, press **SELECT**.
11. Press **READY** when the reading has stabilized in the reference condition (may take 30 minutes or more). You can follow the stabilization from the **GRAPH** display.
12. Enter the correct reference value with the arrow buttons. Press **OK**.
13. Confirm the adjustment by pressing **YES**.
14. The adjustment is done. Press **BACK** and **EXIT** to return to the basic display.
15. Turn off the MI70 and detach the connection cable.

Two-Point Adjustment Using a Calibrator

Note that the difference between the two reference humidities must be at least 50 %. MI70 indicator is used now only as a terminal for visualizing and setting the transmitter's RH reading.

Follow steps 1 to 7 on page 42 and continue as follows:

8. Remove the filter from the transmitter's probe and insert the probe into the lower humidity reference condition.
9. Press **ADJUST** to continue adjusting.
10. Choose 2-point adjustment from the MI70 adjustment menu, press **SELECT**.
11. Press **READY** when the reading has stabilized in the first reference condition (may take 30 minutes or more). You can follow the stabilization from the **GRAPH** display.
12. Enter the correct reference value in the first condition with the arrow buttons. Press **OK**.
13. Remove the probe from the first reference conditions and insert the probe into the higher humidity reference condition.
14. Press **READY** when the reading has stabilized in the second reference condition (may take 30 minutes or more). You can follow the stabilization from the **GRAPH** display.
15. Enter the correct reference value in the second condition with the arrow buttons. Press **OK**.
16. Confirm the adjustment by pressing **YES** (by pressing **NO** you return to adjustment mode display and no changes are made). If the difference between the two reference conditions is less than 50 %RH, adjustment can not be done.
17. The adjustment is done. Press **BACK** and **EXIT** to return to the basic display.
18. Turn off the MI70 and detach the connection cable.

LiCl-NaCl Adjustment

This adjustment is done using relative humidity references 11.3 % RH (LiCl) and 75.5 % RH (NaCl).

Follow steps 1 to 7 on page 42 and continue as follows:

8. Remove the filter from the transmitter's probe and insert the probe into the LiCl salt chamber.
9. Press **ADJUST** to continue adjusting.
10. Choose **LiCl-NaCl autom.** from the MI70 adjustment menu, press **SELECT**. Press **OK** to accept the note telling about references.
11. Press **READY** when the reading has stabilized in the LiCl salt chamber (may take 30 minutes or more). You can follow the stabilization from the **GRAPH** display.
12. Remove probe from the LiCl salt chamber and insert the probe into the NaCl salt chamber.
13. Press **READY** when the reading has stabilized in the NaCl salt chamber (may take 30 minutes or more). You can follow the stabilization from the **GRAPH** display.
14. Confirm the adjustment by pressing **YES** (by pressing **NO** you return to adjustment mode display and no changes are made).
15. The adjustment is done. Press **BACK** and **EXIT** to return to the basic display.
16. Turn off the MI70 and detach the connection cable.











Calibration and Adjustment of HMP230/240 Transmitters and HMM210 Modules

You are able to check and adjust only humidity channel, temperature channel can only be checked. Calibrate your transmitter/module against a calibrated reference probe of HM70 or against a calibrator's reference humidity by using MI70 indicator in communication. Follow the first 12 steps and continue according to the chosen calibration method.

1. In case you have a transmitter provided with heated probe, carry out these preparations before calibration.

HMP240 transmitter with a probe heating: The heating function is turned off automatically when the connection has been established in step 10.

HMM210 module with chemical purge function (re-gain) or with probe heating option: Before calibration activate the re-gain function by resetting the device. Let stabilize to the ambient conditions. Turn off the heating; use a calibration jumper (HMM211) specified in the HMM211's User's Guide (section: Temperature calibration of dewpoint module) or serial commands (HMM213). For further information, see User's Guide of the modules.

2. Connect the 27159ZZ-calibration cable to the
 - **X5** connector of the HMP230/HMP240-series transmitter (X5 connector = 6-pin connector on the left side of the motherboard).
 - **calibration connector** of the HMM210 module.
3. Connect the other end of the calibration cable to either of the HM70's connector port located on the bottom of the indicator, see Figure 7 on page 40.
4. Turn on the HM70.
5. Open the **MENU**: press   **OPEN**.
6. Select **►Functions**, press .
7. Select **►Calibrate transmitters**, press .
8. Select **1.Baud rate** and **2.Serial format**. Press  **SET** to change the serial settings. Serial settings of the transmitter/module and HM70 shall be the same. HMP230/240 default serial settings: 4800, 7, even 1. HMM210 module's default settings: 1200, 8, None. Note! HMM213 shall be in RUN or STOP mode.
9. Select **3.Start calibration**, press  **START**. If the serial settings of HM70 are not compatible with the settings of HMP230, or the cable connection is not working check that the serial settings of HMP230 and the settings of HM70 are the same. Check the cable connection. Then retry connection in step 6.
10. After connection has been established start the adjustment by pressing  **OK**.
11. Select the quantity to check RH/T (view only), press  **SELECT**.
12. If RH selected, check the environment settings of HM70 probe, if needed. Press  **YES** or  **NO**.

The first row shows the reading of the probe/transmitter connected to the port I, the second row shows the reading of the probe/transmitter connected to the port II. The third row RH/T is the difference between the readings of the ports. By pressing \ominus BACK you return to the selection display.

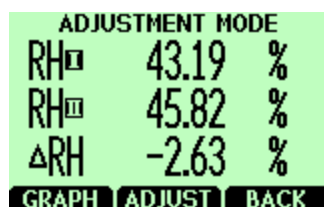

Figure 8 Example of the RH display

Field Checking and Adjustment of Humidity by Using a Calibrated Reference Probe

Follow the steps from 1 to 12 and continue as follows:

13. Ensure that the probes are located in the same conditions.
14. Wait until the readings have stabilized. If the difference between the humidity readings is less than 2 % RH, there is no immediate need for adjustment.
15. Adjust the transmitter reading to correspond a reading of the reference probe by pressing \ominus ADJUST.
16. Select To same as RH_{II} . Press \ominus SELECT.
17. Confirm by pressing \ominus YES
18. Press \ominus BACK, \ominus EXIT, \ominus EXIT to return to the basic display.

1-Point Humidity Adjustment by Using a Calibrator

You can use Vaisala humidity calibrator HMK15 to achieve the reference humidities. MI70 indicator is working as a communicator in the calibration procedure.

Follow the steps from 1 to 12 and continue as follows:

13. Insert the transmitter probe to the reference humidity

14. Press **⊖ ADJUST**
15. Select **1-point adjustment**. press **⊖ SELECT**
16. Wait until the reading is stabilized (takes about 30 minutes). You can follow the stabilization from the **⊖ GRAPH** display.
17. Press **⊖ READY** when the value is stabilized in the reference humidity.
18. Enter the correct humidity value by using the arrow buttons. Press **⊖ OK**.
19. Confirm by pressing **⊖ YES**
20. Press **⊖ BACK**, **⊖ EXIT**, **⊖ EXIT** to return to the basic display.

2-Point Adjustment by Using a Calibrator

You can use Vaisala humidity calibrator HMK15 in calibration and adjustment. Note that the difference between the two reference humidities shall be at least 50 %. MI70 indicator is working as a communicator in the calibration procedure.

Follow the steps from 1 to 12 and continue as follows:

13. Insert the transmitter probe to the first reference humidity.
14. Press **⊖ ADJUST**
15. Select **2-point adjustment**. press **⊖ SELECT**
16. Wait until the reading is stabilized (takes about 30 minutes). You can follow the stabilization from the **⊖ GRAPH** display.
17. Press **⊖ READY** when the value is stabilized in the first reference humidity.
18. Enter the first reference humidity value by using the arrow buttons. Press **⊖ OK**.
19. Insert the transmitter probe to the second reference humidity.
20. Wait until the reading is stabilized (takes about 30 minutes or more). You can follow the stabilization from the **⊖ GRAPH** display.
21. Press **⊖ READY** when the value is stabilized in the second reference humidity.
22. Enter the second reference humidity value by using the arrow buttons. Press **⊖ OK**.

23. Confirm by pressing \ominus YES
24. Press \ominus BACK, \ominus EXIT, \ominus EXIT to return to the basic display.

Calibration and Adjustment of HMT320 Series Transmitters

You can check and adjust both humidity and temperature channels. Make the temperature adjustment first in case you adjust both channels. Calibrate your transmitter against a calibrated reference probe of HM70 or against a calibrator's reference humidity by using MI70 indicator in communication. Follow the first 8 steps and continue according to the chosen calibration method.

1. Connect the 211339-calibration cable to the **RS232** connector in the mother board of the HMP300-series transmitter
2. Connect the other end of the calibration cable to either of the HM70's connector port located on the bottom of the indicator, see Figure 7 on page 40.
3. Turn on both devices (the HMT300-series transmitter can be on all the time).
4. The reading of the transmitter is shown on the first or middle row of the display, depending on the connector port to which the calibration cable is connected. Value of the port I is shown on the upper row of the display and the value of the port II on the lower row of the display. Difference of the readings is shown in the lowest row.
5. Take off the **CAL.DIS** jumper from the motherboard of the HMT300 transmitter. Now MI70 is moved into **Adjustment mode**.
6. Press \ominus OK to start adjustment.
7. Select RH or T, press \ominus SELECT.
8. Check the environment settings, if needed. Otherwise press \ominus NO.

Field Checking and Adjustment by Using a Calibrated Reference Probe

Follow the steps from 1 to 8 and continue as follows:

9. Check that the probes are located in equal conditions and wait until the readings are stabilized (can take 30 minutes or more). If you are near the probes, do not breathe in their direction.
10. Press \ominus **ADJUST** to continue adjusting.
11. Press **To same asRH_{ref.}**, press \ominus **SELECT**. (MI70 recognizes always the port to which the HMP70-series probe is connected).
12. Confirm by pressing \ominus **YES**.
13. Adjustment is done. Press \ominus **BACK** and \ominus **EXIT** to return to the basic display.
14. Replace the **CAL.DIS** jumper.
15. Switch off the MI70 and detach the calibration cable from MI70 and from the transmitter.

1-Point Adjustment by Using a Calibrator

When adjusting a transmitter only in one reference condition, please take care that the reference condition represents well the measuring environment.

If you use humidity calibrator HMK15, please use the adapter fitting (13.5 mm) on the measurement hole if you calibrate probes of HMT324, HMT325, HMT327 and HMT328.

Follow the steps from 1 to 8 and continue as follows:

9. Remove the filter from the transmitter's probe and insert the probe into the reference condition.
10. Press \ominus **ADJUST** to continue adjusting.
11. Select **1-point adjustment**, press \ominus **SELECT**.
12. Press \ominus **READY** when the reading is stabilized in the reference condition (takes about 30 minutes or more). You can follow the stabilization from the \ominus **GRAPH** display.

13. Enter correct reference value by using the arrow buttons. Press \ominus OK.
14. Confirm by pressing \ominus YES.
15. Adjustment is done. Press \ominus BACK and \ominus EXIT to return to the basic display.
16. Replace the jumper to CAL.RH pins.
17. Switch off HM70 and detach the calibration cable from MI70 and from the transmitter.

2-Point Adjustment by Using a Calibrator

Note that the difference between the two reference humidities shall be at least 50 %. MI70 indicator is used now as a communicator. HMP70 probe can be connected or it can be removed while making this adjustment.

If you use humidity calibrator HMK15, please use the adapter fitting (13.5 mm) on the measurement hole if you calibrate probes of HMT324, HMT325, HMT327 and HMT328.

Follow the steps from 1 to 8 and continue as follows:

9. Remove the filter from the transmitter's probe and insert the probe into lower reference humidity.
10. Press \ominus ADJUST to continue adjusting.
11. Select 2-point adjustment, press \ominus SELECT.
12. Press \ominus READY when the reading is stabilized in the first reference condition (takes about 30 minutes or more).
13. Enter correct reference value by using the arrow buttons. Press \ominus OK.
14. Remove the probe and insert the probe into higher reference humidity. You can follow the stabilization from the \ominus GRAPH display (takes about 30 minutes or more).
15. Press \ominus READY when the reading is stabilized in the second reference condition.
16. Give the higher reference humidity value by using the arrow buttons. Press \ominus OK.
17. Confirm the adjustment, press \ominus YES (by pressing \ominus NO you return to adjustment mode display and no changes are made). If

the difference between two references is less than 50 %, adjustment can not be done.

18. Adjustment is done. Press \ominus **BACK** to exit the adjustment mode press \ominus **EXIT** to return to the basic display.
19. Replace the jumper to **CAL.RH** pins.
20. Switch off MI70 and detach the calibration cable from the MI70 and from the transmitter.

Calibration and Adjustment of HMT330 Series Transmitters

You can check and adjust both humidity and temperature channels of the HMT330. If you adjust both channels, make the temperature adjustment first.

Calibrate your transmitter against a calibrated reference probe of HM70 or against a calibrator's reference humidity by using MI70 indicator in communication. Follow the first 8 steps and continue according to the chosen calibration method.

1. Connect the 211339-calibration cable to the **SERVICE PORT** connector on the mother board of the HMP330.
2. Connect the other end of the calibration cable to either of the HM70's connector port located on the bottom of the indicator, see Figure 7 on page 40.
3. Turn on both devices.
4. The reading of the transmitter is shown on the first or middle row of the display, depending on the connector port to which the calibration cable is connected. Value of the port I is shown on the upper row of the display and the value of the port II on the lower row of the display. Difference of the readings is shown on the lowest row.
5. If you have HMT330 with the optional chemical purge option, you should activate the chemical purge before calibration and adjustment. You can do this via the MI70 indicator: open the **MENU**; press \ominus **OPEN** select **Functions**, press **START** and **YES**. Wait until the purge is complete before continuing with calibration and adjustment.
6. Press the **ADJ** button (on the mother board of the HMT330) to open the adjustment mode. The indicator led (on the motherboard of the HMT330) starts flashing.

From now on the adjustment is carried out by using the MI70 indicator.

7. Press \ominus OK to start adjustment.
8. Select RH or T, press \ominus SELECT.
9. If RH selected, check the environment settings, if needed. Otherwise press \ominus NO.

Field Checking and Adjustment by Using a Calibrated Reference Probe

Follow the steps from 1 to 8 on page 52 and continue as follows:

9. Check that the probes are located in equal conditions and wait until the readings are stabilized (can take 30 minutes or more). If you are near the probes, do not breathe in their direction.
10. Press \ominus ADJUST to continue adjusting.
11. Press **To same as RH_{in}**, press \ominus SELECT. (MI70 recognizes always the port to which the HMP70-series probe is connected).
12. Confirm by pressing \ominus YES.
13. Adjustment is done. Press \ominus BACK and \ominus EXIT to return to the basic display.
14. Switch off the MI70 and detach the calibration cable.

1-Point Adjustment by Using a Calibrator

When adjusting a transmitter only in one reference condition, please take care that the reference condition represents the measuring environment. MI70 indicator is used now in communication.

If you use humidity calibrator HMK15, please use the adapter fitting (13.5 mm) on the measurement hole if you calibrate probes of HMT334, HMT335, HMT337 and HMT338.

Follow the steps from 1 to 8 on page 52 and continue as follows:

9. Remove the filter from the transmitter's probe and insert the probe into the reference condition.
10. Press \ominus **ADJUST** to continue adjusting.
11. Select **1-point adjustment**, press \ominus **SELECT**.
12. Press \ominus **READY** when the reading is stabilized in the reference condition (takes about 30 minutes or more). You can follow the stabilization from the \ominus **GRAPH** display.
13. Enter correct reference value by using the arrow buttons. Press \ominus **OK**.
14. Confirm by pressing \ominus **YES**.
15. Adjustment is done. Press \ominus **BACK** and \ominus **EXIT** to return to the basic display.
16. Switch off the MI70 and detach the calibration cable.

2-Point Adjustment by Using a Calibrator

Note that the difference between the two reference humidities shall be at least 50 %. MI70 indicator is used now in communication.

If you use humidity calibrator HMK15, please use the adapter fitting (13.5 mm) on the measurement hole if you calibrate probes of HMT334, HMT335, HMT337 and HMT338.

Follow the steps from 1 to 8 on page 52 and continue as follows:

9. Remove the filter from the transmitter's probe and insert the probe into lower reference humidity.
10. Press \ominus **ADJUST** to continue adjusting.
11. Select **2-point adjustment**, press \ominus **SELECT**.
12. Press \ominus **READY** when the reading is stabilized in the first reference condition (takes about 30 minutes or more).
13. Enter correct reference value by using the arrow buttons. Press \ominus **OK**.
14. Remove the probe and insert the probe into higher reference humidity. You can follow the stabilization from the \ominus **GRAPH** display (takes about 30 minutes or more).
15. Press \ominus **READY** when the reading is stabilized in the second reference condition.

16. Give the higher reference humidity value by using the arrow buttons. Press \ominus **OK**.
17. Confirm the adjustment, press \ominus **YES** (by pressing \ominus **NO** you return to adjustment mode display and no changes are made). If the difference between two references is less than 50 %, adjustment can not be done.
18. Adjustment is done. Press \ominus **BACK** to exit the adjustment mode press \ominus **EXIT** to return to the basic display.

LiCl-NaCl Adjustment

This adjustment is done by using relative humidity references: 11.3 % RH (LiCl) and 75.5 % RH (NaCl)

If you use humidity calibrator HMK15, please use the adapter fitting (13.5 mm) on the measurement hole if you calibrate probes of HMT334, HMT335, HMT337 and HMT338.

Follow the steps from 1 to 8 on page 52 and continue as follows:

9. Remove the filter from the transmitter's probe and insert the probe into 11.3 % RH reference humidity.
10. Press \ominus **ADJUST** to continue adjusting.
11. Select **LiCl-NaCl autom.**, press \ominus **SELECT**. Press \ominus **OK** to accept the note telling about references.
12. Press \ominus **READY** when the reading is stabilized in the first reference condition (takes about 30 minutes or more).
13. Remove the probe and insert the probe into 75.5 % reference humidity. You can follow the stabilization from the \ominus **GRAPH** display (takes about 30 minutes or more).
14. Press \ominus **READY** when the reading is stabilized in the second reference condition.
15. Confirm the adjustment, press \ominus **YES** (by pressing \ominus **NO** you return to adjustment mode display and no changes are made).
16. Adjustment is done. Press \ominus **BACK** to exit the adjustment mode press \ominus **EXIT** to return to the basic display.

Field Checking of DMW19 Transmitter

You are able to use MI70 as a display and check your DMW19 transmitter against a calibrated reference probe of HM70.

1. Turn on the DMW19.
2. Remove the lid of the DMW19 transmitter.
3. Connect the 211917ZZ- cable to the 6-pins test connector (cable connector position: Vaisala-logo on top) of the DMW19.
4. Connect the other end of the calibration cable to either of the HM70's connector port located on the bottom of the indicator, see Figure 7 on page 40.
5. Turn on the HM70.
6. The reading of the DMW19 transmitter is shown on the first or middle row of the HM70 display, depending on the connector port to which the calibration cable is connected. Value of the port I is shown on the upper row of the display and the value of the port II on the lower row of the display. Difference of the readings is shown in the lowest row.
7. Turn off the HM70.
8. Remove the connection cable and replace the lid of the DMW19.

CHAPTER 10

**MEASURING OTHER PARAMETERS
SIMULTANEOUSLY**

The MI70 indicator is a generic indicator that can be used with Vaisala interchangeable dewpoint (DMP) and carbon dioxide (GMP) probes. Two different probes can be used simultaneously.

1. Turn off the device.
2. Connect the DMP70/GMP70 probe to the other connector port in the bottom of the indicator.
3. Turn on the device.
4. Check that the pressure settings of the probes (port I and II) are the same, if you are taking measurements from the same condition.
5. The display shows now the reading of the port I probe in the upper row(s) and the reading of the port II in the lower row(s).

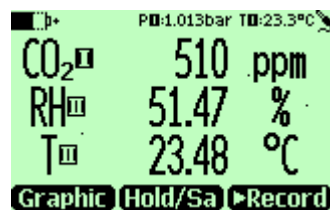

Example of the display when carbon dioxide and humidity probe connected simultaneously to the MI70 indicator.

This page intentionally left blank.

CHAPTER 11

ANALOG OUTPUT CONNECTION

Selecting and Scaling the Analog Output

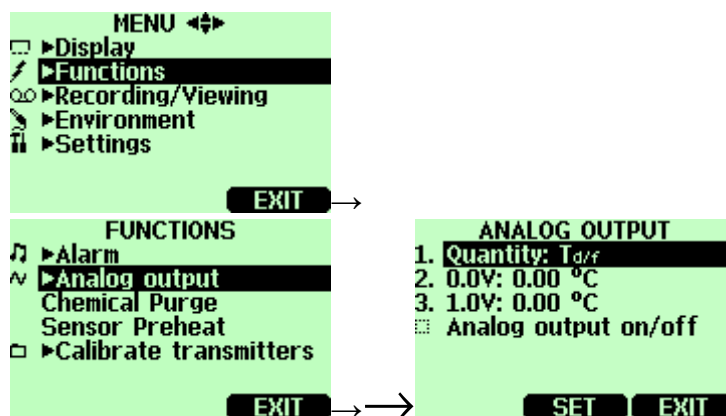

To get analog measurement data, you need the analog output signal cable, see list of accessories on page 77. One voltage signal channel 0...1.0V can be scaled for the selected quantity.

1. Connect the analog output signal cable connector to the indicator base connector. Connect the screw terminal block as follows:

Brown wire:	common wire (-)
Yellow-green wire:	signal (+)

2. Open the MENU: press OPEN.
3. Select ►Functions, press .
4. Select ►Analog output, press .

5. Select **Quantity** and press \ominus **SET** to choose a quantity.
6. Select **Quantity**, press \ominus **SELECT**. (One quantity can be chosen at a time. Only active quantities can be selected. To change the quantities, go to **MENU**►**Display**►**Quantities and units**).
7. Select **0.0 V** to set the value for the 0.0V output signal, press \ominus **SET**. (If the analog output is ON, take it OFF) Set the low value by using arrow buttons. Press \ominus **+/-** button to choose the sign of the value. Press \ominus **OK** to make the setting.
8. Select **1.0V** to set the value for the 1.0V output signal, press \ominus **SET**. Set the high value by using arrow buttons. Press \ominus **+/-** button to choose the sign of the value. Press \ominus **OK** to make the setting.
9. Select **Analog output on/off**, press \ominus **ON** to activate the analog output and return back to the basic display.
10. A wave picture sign \sim appears on the upper left corner of the basic display.
11. To deactivate the analog output function, go to **MENU**→►**Functions** ►**Analog output** ► **Analog output on/off** and press \ominus **OFF**.

CHAPTER 12

CALIBRATION AND ADJUSTMENT OF HM70 SERIES PROBES

General Information about Calibrations

The HM70 is fully calibrated as shipped from factory. Adjustment shall be done if there is a reason to believe that device is not within the accuracy specifications. However, if HM70 is used as a reference instrument in humidity measurements, the humidity recalibration is recommended every year.

It is recommended to send the device to Vaisala Service Centers for calibration, see contact information on page 68. Alternatively user can calibrate and adjust HM70 by following the instructions given in this chapter.

When using Vaisala humidity calibrator HMK15, use the adapter fitting (13.5 mm hole) with the probes HMP76 and HMP77. Probe HMP75 does not need the adapter fitting. If chemical purge option is available, it should always be performed before calibration, see page 34.

Before starting the adjustment mode, remove the screw that covers the calibration button. Refer to Figure 2 on page 11 for the location of the button.

Relative Humidity Adjustment

LiCl-NaCl Automatic Adjustment

LiCl-NaCl automatic adjustment is a two-point adjustment in reference humidities of 11.3 % (LiCl) and 75 % (NaCl). You do not have to feed the reference values, the HM70 displays the accurate value based on the measured temperature and the Greenspan table

stored into the memory of the HM70. Make the adjustment as instructed in the following section *2-Point Adjustment* (select **LiCl--NaCl autom.** on item 9 and follow the display instructions).

2-Point Adjustment

Low humidity references 0 % (Nitrogen)/ 11.3 % (LiCl) and higher humidity references 75 % (NaCl)/ 97 % (K₂SO₄) are recommended for two-point adjustment. Ensure that the difference between the humidity references is more than 50 %.

1. When adjusting both relative humidity and temperature, please make the temperature adjustment first.
2. Check that the HM70 is switched on.
3. If chemical purge option is available perform it before adjustment, see page 34.
4. Take out the screw from the probe handle to expose the calibration button. Press the button with a small screwdriver. When pressing the button, indicator turns to adjusting mode.
5. Press **⊖ OK** to start the adjustment mode.
6. Select **RH**, press **⊖ SELECT**.
7. Press **⊖ YES** to check the environmental settings, to continue directly adjustment press **⊖ NO**.
8. Now the adjustment mode is on, press **⊖ ADJUST** to select the adjustment method.
9. Select **2-point adjustment**, press **⊖ SELECT**. Press **⊖ OK** to continue.
10. Set the probe to a lower reference relative humidity. If using HMK15 calibrator, use the adapter fitting (13.5 mm hole) with probes HMP76 and HMP77.

You can follow the stabilization from the **⊖ GRAPH** display. Press **⊖ READY** when the reading is stabilized.

11. Give the lower reference humidity value by using the arrow buttons. Press \ominus **OK**.
12. Set the probe to the higher reference humidity. Press \ominus **READY** when the reading is stabilized. You can follow the stabilization from the \ominus **GRAPH** display.
13. Give the higher reference relative humidity value by using the arrow buttons. Press \ominus **OK**.
14. Confirm the adjustment, press \ominus **YES** (by pressing \ominus **NO** you return to adjustment mode display and no changes are made). If the difference between two references is less than 50 %, adjustment can not be done.
15. Adjustment has been carried out. Press \ominus **BACK** to exit the adjustment mode press \ominus **EXIT** to return to the basic display.
16. Replace the screw onto calibration button.

You can attach a sticker on the calibration button screw to seal the calibration.

1-Point Adjustment

Usually it is recommended to make an adjustment in two reference humidities. If adjustment is done by using one reference humidity (1-point adjustment), select the reference humidity so that it represents the measuring environment. Make the adjustment in one point as instructed in the previous section *2-Point Adjustment* (select **1-point adjustment** and follow the display instructions).

Temperature Adjustment

Temperature adjustment in one or two points can be done if there is reason to believe that the adjustment is changed. If adjustment is done only in one point, reference condition shall represent the measuring environment.

1. Take out the screw covering the calibration button (in the probe handle).
2. Press the calibration button. For pressing, use tool with thin and sharp point, such as small screwdriver. When pressing the button, indicator turns to adjusting mode.
3. Select T, press \ominus SELECT.
4. Now the adjustment mode is on, press \ominus ADJUST to select the adjustment method: **1-point adjustment** or **2-point adjustment**.

1-Point Adjustment

Follow the steps from 1 to 4 and continue as follows:

5. Select **1-point adjustment**, press \ominus SELECT.
6. Set the probe to a reference temperature. You can follow the stabilization from the \ominus GRAPH display. Press \ominus READY when the reading is stabilized in the reference.
7. Give the reference temperature value by using the arrow buttons. Press \ominus OK.
8. Confirm the adjustment, press \ominus YES. (By pressing \ominus NO you return to adjustment mode display and no changes are made).
9. Calibration is carried out. Press \ominus BACK to exit the adjustment mode and \ominus EXIT to return to the basic display.

2-Point Adjustment

Follow the steps from 1 to 4 and continue as follows:

5. Select **2-point adjustment**. Press \ominus **SELECT** to continue.
6. Set the probe to a lower reference temperature. You can follow the stabilization from the \ominus **GRAPH** display.
7. Press \ominus **READY** when the reading is stabilized. Give the lower reference temperature by using the arrow buttons. Press \ominus **OK**.
8. Set the probe to the higher reference temperature. You can follow the stabilization from the \ominus **GRAPH** display. Press \ominus **READY** when the reading is stabilized.
9. Give the higher reference temperature by using the arrow buttons. Press \ominus **OK**.
10. Confirm the adjustment, press \ominus **YES**. (By pressing \ominus **NO** you return to adjustment mode display and no changes are made). If the difference between two references is less than 30 °C, adjustment can not be done.
11. Calibration is carried out. Press \ominus **BACK** to exit the adjustment mode and \ominus **EXIT** to return to the basic display.

Last Adjustment Date

To see the last adjustment date, select **Last adjustment date**. You can check this date also from the **Device information**, see page 27.

This page intentionally left blank.

CHAPTER 13

MAINTENANCE

Changing the Filter

1. Remove the dirty filter from the probe; see Figure 2 on page 11. Do not try to clean the filter. Avoid touching the sensor.
2. Install the new filter.

Changing the Battery Pack

A new rechargeable battery pack can be ordered from Vaisala. Change the battery pack as follows, and refer to Figure 9 on page 68:

1. Open the back plate of the indicator by opening the screw of the back plate.
2. Remove the old battery pack. Detach the black connector by pulling up carefully from the wires.
3. Connect the black connector of the new battery pack, ensure that the position of the connector is as indicated in figure (red and black wires are on the upper edge of the connector). Do not push the connector with conducting material, e.g. metallic screwdriver.
4. Place the battery pack, close the back plate and tighten the screw.
5. Charge the battery pack before use; see page 13.

In case you are installing battery pack and you have a device with alkaline batteries, remove the metal contact before installing the battery pack.

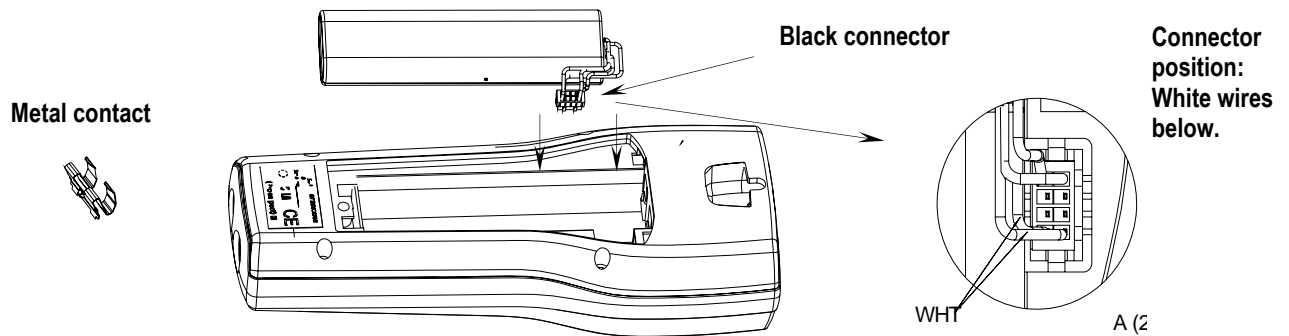

Figure 9 Installing the battery pack

Error Messages

If the HM70 displays an error message, check first that the sensor is connected properly. If there is condensed water in the probe, let the probe dry before resuming measurement.

In case of constant error, please contact Vaisala Service Centers (see page 68).

Error Messages

- Voltage required for Purge unavailable
- Voltage required for Preheat unavailable
- Eeprom read/write error
- ADC malfunction
- Operating voltage out of range
- Analog voltage out of range
- Temperature/Humidity sensor open/short circuit
- Temperature sensor current leak
- Temperature/humidity measurement malfunction
- Temperature value out of range
- Relative humidity value out of range
- Sensor not found
- Amplifier chain malfunction

Technical Support

For technical questions, contact the Vaisala technical support:

E-mail helpdesk@vaisala.com

Fax +358 9 8949 2790

Return Instructions

If the product needs repair, please follow the instructions below to speed up the process and to avoid extra costs to you.

1. Read the section Warranty on page 7.
2. Contact a Vaisala Service Center or a local Vaisala representative. The latest contact information and instructions are available from www.vaisala.com. Addresses of the Service Centers are provided in section Vaisala Service Centers on page 70.

Please have the following information on hand:

- serial number of the unit
 - date and place of purchase or last calibration
 - description of the fault
 - circumstances in which the fault occurs/occurred
 - name and contact information of a technically competent person who can provide further information on the problem
3. Pack the faulty product in a strong box of adequate size, with proper cushioning material to avoid damage.
 4. Include the information specified in step 2 in the box with the faulty product. Also include a detailed return address.
 5. Ship the box to the address specified by your Vaisala contact.

Vaisala Service Centers

Vaisala Service Centers perform calibrations and adjustments as well as repair and spare part services. See contact information below.

Vaisala Service Centers also offer accredited calibrations, maintenance contracts, and a calibration reminder program. Do not hesitate to contact them to get further information.

NORTH AMERICAN SERVICE CENTER

Vaisala Inc., 10-D Gill Street, Woburn, MA 01801-1068, USA.

Phone: +1 781 933 4500, Fax: +1 781 933 8029

E-mail: us-customersupport@vaisala.com

EUROPEAN SERVICE CENTER

Vaisala Instruments Service, Vanha Nurmijärventie 21 FIN-01670 Vantaa, FINLAND.

Phone: +358 9 8949 2658, Fax: +358 9 8949 2295

E-mail: instruments.service@vaisala.com

TOKYO SERVICE CENTER

Vaisala KK, 42 Kagurazaka 6-Chome, Shinjuku-Ku, Tokyo 162-0825, JAPAN.

Phone: +81 3 3266 9617, Fax: +81 3 3266 9655

E-mail: aftersales.asia@vaisala.com

BEIJING SERVICE CENTER

Vaisala China Ltd., Floor 2 EAS Building, No. 21 Xiao Yun Road, Dongsanhuan Beilu, Chaoyang District, Beijing, P.R. CHINA 100027.

Phone: +86 10 8526 1199, Fax: +86 10 8526 1155

E-mail: china.service@vaisala.com

www.vaisala.com

CHAPTER 14

TECHNICAL SPECIFICATIONS**Probes HMP75, HMP76 and HMP77****Measured Variables****Relative Humidity**

Measurement range	0 ... 100%RH
Accuracy (including non-linearity, hysteresis and repeatability)	
at +15...+25 °C	1 % RH (0 ... 90 % RH)
at -20...+40 °C	1.7 % RH (90 ... 100 % RH)
at -40 ... -20 °C, +40 ... +180 °C	(1.0 + 0.008 x reading) % RH
	(1.5 + 0.015 x reading) % RH
Factory calibration uncertainty (**) (+20 °C)	
	± 0.6 % RH (0...40 % RH)
	± 1.0 % RH (40...97 % RH)

(**) Defined as ± 2 standard deviation limits. Small variations possible, see also calibration certificate.

Humidity sensors for HM70:

HUMICAP® 180R	
HUMICAP® 180RC	(chemical purge, sensor preheat)

Response time (90 %) at 20 °C in 0.1 m/s air flow
 17 s with grid filter
 50 s with grid + steel netting filter
 60 s with sintered filter

Temperature

Measurement ranges

HMP75	-20 ... +60 °C
HMP76	-50 ... +120 °C
	(to +180 °C temporarily)
HMP77	-70 ... +180 °C
Accuracy at +20°C	±0.2 °C

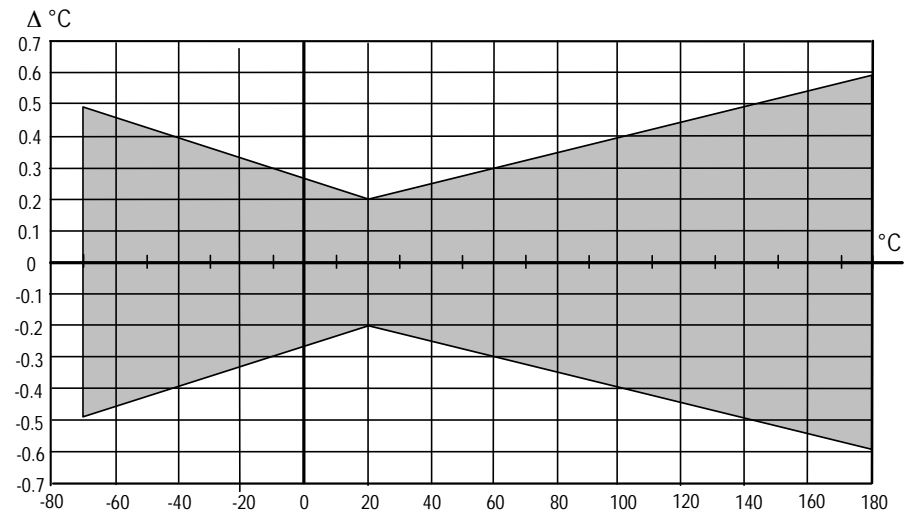

Figure 10 Accuracy over temperature range

Temperature sensor Pt 100 RTD 1/3 Class B IEC 751

Calculated Variables

Typical Ranges

Dewpoint temperature	-20 ... +100 °C, -4 ... +212 °F
Mixing ratio	0 ... 600 g/kg dry air
Absolute humidity	0 ... 600 g/m ³

Wet bulb temperature	0 ... +100 °C, 32 ... +212 °F
Enthalpy	0 ... 160 kJ/g
Water vapor pressure	0 ... 1000 hPa

Accuracies of Calculated Variables

Accuracies of the calculated variables depend on the calibration accuracy of the humidity and temperature sensors; here the accuracies are given for ± 2 %RH and ± 0.2 °C.

Accuracy of Dewpoint Temperature °C

Temp.	Relative humidity									
	10	20	30	40	50	60	70	80	90	100
-40	1.86	1.03	0.76	0.63	0.55	0.50	0.46	0.43	—	—
-20	2.18	1.19	0.88	0.72	0.62	0.56	0.51	0.48	—	—
0	2.51	1.37	1.00	0.81	0.70	0.63	0.57	0.53	0.50	0.48
20	2.87	1.56	1.13	0.92	0.79	0.70	0.64	0.59	0.55	0.53
40	3.24	1.76	1.27	1.03	0.88	0.78	0.71	0.65	0.61	0.58
60	3.60	1.96	1.42	1.14	0.97	0.86	0.78	0.72	0.67	0.64
80	4.01	2.18	1.58	1.27	1.08	0.95	0.86	0.79	0.74	0.70
100	4.42	2.41	1.74	1.40	1.19	1.05	0.95	0.87	0.81	0.76
120	4.86	2.66	1.92	1.54	1.31	1.16	1.04	0.96	0.89	0.84
140	5.31	2.91	2.10	1.69	1.44	1.26	1.14	1.05	0.97	0.91
160	5.80	3.18	2.30	1.85	1.57	1.38	1.24	1.14	1.06	0.99

Accuracy of Mixing Ratio g/kg

(ambient pressure 1013 mbar)

Temp.	10	Relative humidity								
		20	30	40	50	60	70	80	90	100
-40	0.003	0.003	0.003	0.003	0.003	0.004	0.004	0.004	—	—
-20	0.017	0.018	0.019	0.021	0.022	0.023	0.025	0.026	—	—
0	0.08	0.09	0.09	0.10	0.10	0.11	0.11	0.12	0.13	0.13
20	0.31	0.33	0.35	0.37	0.39	0.41	0.43	0.45	0.47	0.49
40	0.97	1.03	1.10	1.17	1.24	1.31	1.38	1.46	1.54	1.62
60	2.68	2.91	3.16	3.43	3.72	4.04	4.38	4.75	5.15	5.58
80	6.73	7.73	8.92	10.34	12.05	14.14	16.71	19.92	24.01	29.29
100	16.26	21.34	28.89	40.75	60.86	98.85	183.66	438.56	—	—
120	40.83	74.66	172.36	—	—	—	—	—	—	—

Accuracy of Wet Bulb Temperature °C

Temp.	Relative humidity									
	10	20	30	40	50	60	70	80	90	100
-40	0.20	0.20	0.20	0.20	0.20	0.20	0.20	0.20	—	—
-20	0.21	0.21	0.22	0.22	0.22	0.22	0.23	0.23	—	—
0	0.27	0.28	0.28	0.29	0.29	0.29	0.30	0.30	0.31	0.31
20	0.45	0.45	0.45	0.44	0.44	0.44	0.43	0.43	0.42	0.42
40	0.84	0.77	0.72	0.67	0.64	0.61	0.58	0.56	0.54	0.52
60	1.45	1.20	1.03	0.91	0.83	0.76	0.71	0.67	0.63	0.60
80	2.23	1.64	1.32	1.13	0.99	0.89	0.82	0.76	0.72	0.68
100	3.06	2.04	1.58	1.31	1.14	1.01	0.92	0.85	0.80	0.75
120	3.85	2.40	1.81	1.48	1.28	1.13	1.03	0.95	0.88	0.83
140	4.57	2.73	2.03	1.65	1.41	1.25	1.13	1.04	0.97	0.91
160	5.25	3.06	2.25	1.82	1.55	1.37	1.24	1.13	1.05	0.99

Accuracy of Absolute Humidity g/m³

Temp.	Relative humidity									
	10	20	30	40	50	60	70	80	90	100
-40	0.004	0.004	0.005	0.005	0.005	0.006	0.006	0.006	—	—
-20	0.023	0.025	0.027	0.029	0.031	0.032	0.034	0.036	—	—
0	0.10	0.11	0.12	0.13	0.13	0.14	0.15	0.15	0.16	0.17
20	0.37	0.39	0.41	0.43	0.45	0.47	0.49	0.51	0.53	0.55
40	1.08	1.13	1.18	1.24	1.29	1.34	1.39	1.44	1.49	1.54
60	2.73	2.84	2.95	3.07	3.18	3.29	3.40	3.52	3.63	3.74
80	6.08	6.30	6.51	6.73	6.95	7.17	7.39	7.61	7.83	8.05
100	12.2	12.6	13.0	13.4	13.8	14.2	14.6	15.0	15.3	15.7
120	22.6	23.3	23.9	24.6	25.2	25.8	26.5	27.1	27.8	28.4
140	39.1	40.0	41.0	42.0	43.0	44.0	45.0	45.9	46.9	47.9
160	63.5	64.9	66.4	67.8	69.2	70.7	72.1	73.5	74.9	76.4

General

Humidity sensor	HUMICAP® 180R HUMICAP® 180RC
Temperature sensor	Pt100 IEC751 1/3 class B
Operating temperature range for electronics	-40 ... +60 °C, -40 ... +140 °F
Standard sensor protection	HMP75 Plastic grid HMP76 Sintered bronze filter HMP77 Grid with SS netting
Housing classification	IP65 (NEMA 4)

Housing material	ABS/ PC blend
Probe material	Stainless steel (AIS316L)
Probe cable length (between indicator and the probe handle)	1.9 m
Probe cable length of HMP77 (from handle to the root of the probe)	5.0 m
Probe diameter	12 mm (0.47 inch)
Weight	
HMP75	250 g
HMP76	350 g
HMP77	500 g

MI70 Indicator

Indicator General

Operating temperature range	-10 ... + 40 °C
Operating humidity	0 ... 100 %RH , non-condensing
Menu languages	English, Finnish, French, German, Spanish, Swedish, Chinese, Russian, Japanese
Display	LCD with backlight Graphic trend display of any quantity Character height up to 16mm
Probe inputs	1 or 2
Power supply	Rechargeable NIMH battery pack with AC-POWER or 4 x AA size alkalines, type IEC LR6
Analog output	0 ... 1 VDC
Output resolution	0.6 mV
Accuracy	0.2 % full scale
Temperature dependence	0.002 %/°C full scale
Minimum load resistor	10 kΩ to ground
Data interface	RS232C (EIA-232)
Data logging capacity	900 ... 2700 real time data points,
Logging interval	1 s to 12 h
Logging duration	1 min ... memory full

Alarm	Audible alarm function
Housing classification	IP54
Weight	400 g
Housing material	ABS/PC-blend

Battery Pack

Operation times in	
continuous use	48 h typical at +20 °C
data logging use	at least 30 days
Power consumption during charge	10W max
Charging time	4 hours

General about Vaisala Hand-Held Humidity and Temperature Meter HM70

Storage temperature	-40 ... +70 °C
Storage humidity range	0 ... 100 % (non-condensing)

Electromagnetic Compatibility

Complies with the following standard:

EN 61326-1:1997 +Am 1:1998+ Am 2:2001, Electrical equipment for measurement, control and laboratory use - EMC requirements: Portable.

Accessories

Description	Order code
AC-Adapters	
Euro AC-adapter	MI70EUROADAPTER
UK AC-adapter	MI70UKADAPTER
US AC-adapter	MI70USADAPTER
AUS AC-adapter	MI70AUSADAPTER
Connection cables	
Analog output signal cable	27168ZZ
Connection cable for HM60/70/140 series	HMA6070
Connection cable for HM20/30/130 series	HMA2030
Connection cable for HMDM200 series	27159ZZ
Connection cable for HM320/330-series	211339
Connection cables for DMW19	211917ZZ
Carrying cases	
Carrying case for one probe (HMP75 or HMP77)	MI70CASE
Carrying case for two probes (HMP75 and HMP76 or GMP-probe)	MI70CASE2
Probe accessories	
HMP75	
Plastic PC grid filter	6221
Membrane filter	10159HM
Sintered bronze filter	DRW212987SP
HMP76/77	
Plastic PPS grid filter	DRW010276SP
Sintered stainless steel filter	HM47280SP
Sintered bronze filter (HMP76 standard)	DRW212987SP
PPS grid with SS netting (HMP77 standard)	DRW010281SP
Probe holder (only for HMP76)	HM36915
Others	
Measurement indicator	MI70
PC Connection tools	
MI70 Link software interface kit including a USB instrument cable for MI70	219687
MI70 Link software interface kit including a serial connection cable for MI70	MI70LINK

Dimensions in mm (inches)



MI70 Indicator

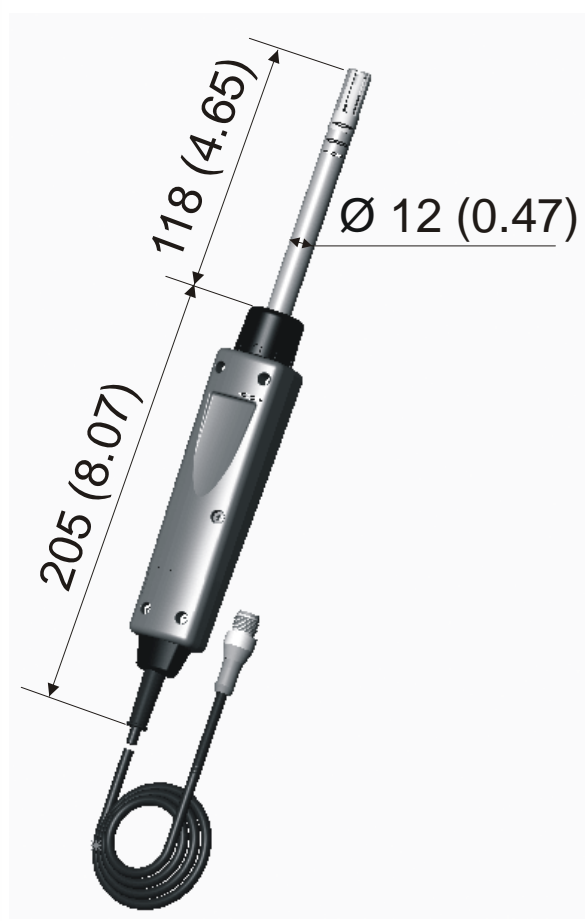

HMP75 Probe



HMP76 Probe

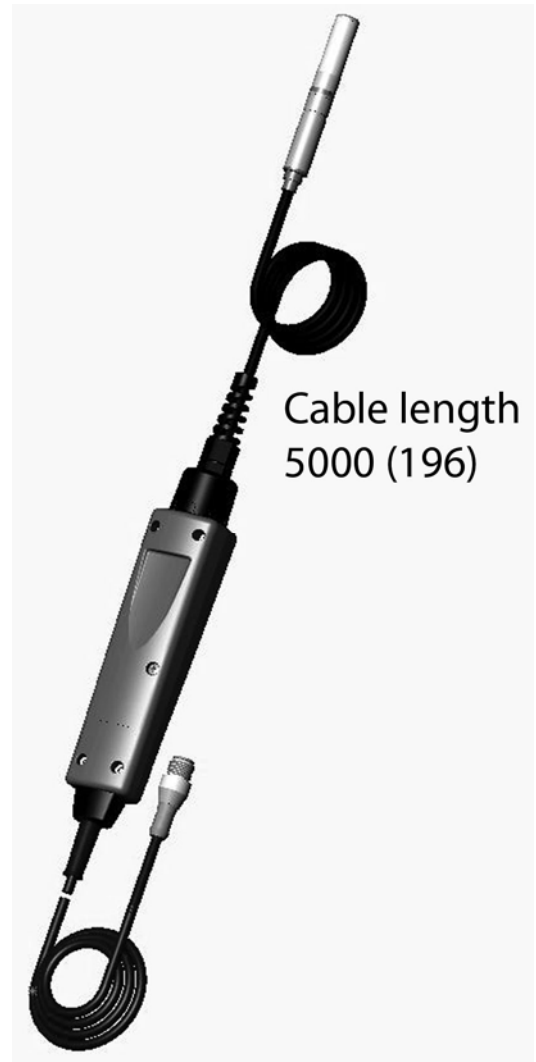

HMP77 Probe

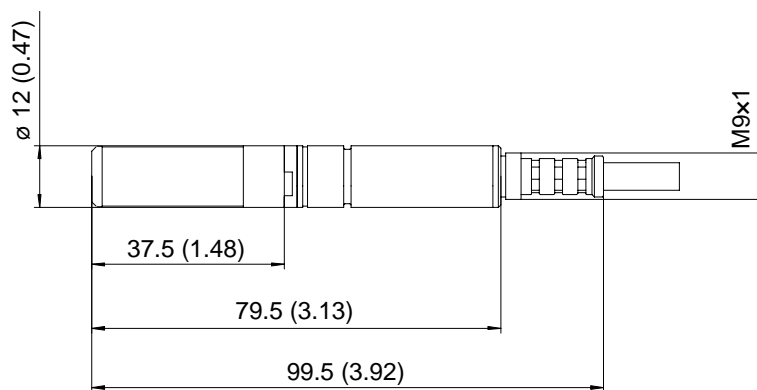

HMP77 Probe

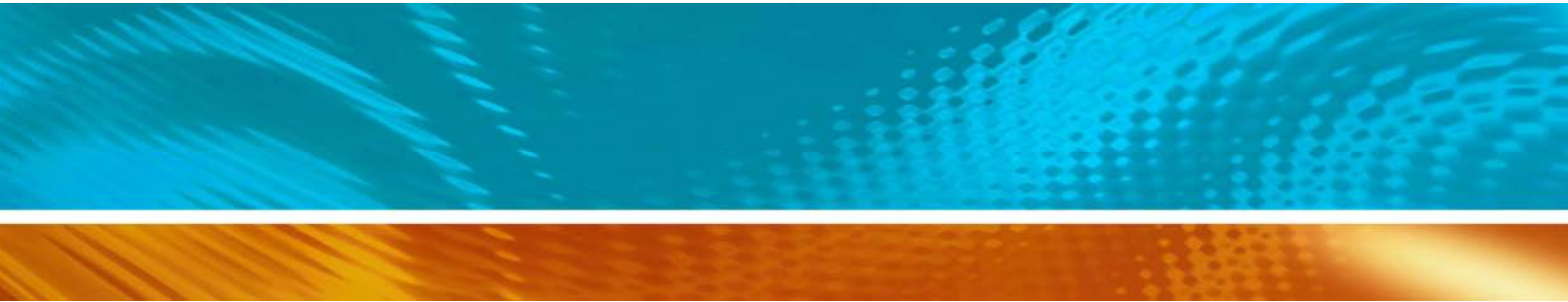

www.vaisala.com

