

---

# Guide to Instantaneous Selectivity

## Circuit Breaker Engineering Reference



This page left intentionally blank

---

## Table of Contents

01	Introduction
02	Assumptions
02	Considerations and Cautionary Notes Regarding Implementation of Instantaneous Selectivity
02	How to Find and Read Values in the Tables
02	Systems with More than Two Circuit Breakers
03	Through Transformer Selectivity
03	Accounting for X/R Ratios Greater than Test Ratios
04	Circuit Breaker Types
04	ANSI/UL 1066 Circuit Breakers with Fully Adjustable Trips
04	UL 489 Circuit Breakers with Fully Adjustable Trips
05	Molded Case Circuit Breakers (MCCB)
05	ArcWatch with Instantaneous Zone Selective Interlocking (I-ZSI) and Waveform Recognition (WFR) Technology
06	EntelliGuard Series Trip Units in ANSI, Power Break II, and Molded Case Circuit Breakers
09	Selectivity with EntelliGuard TU Trip Units in ANSI, Power Break II, and Molded Case Circuit Breakers
10	Selectivity with Record Plus FE and FG
11	Selectivity with Tmax XT
15	ArcWatch I-ZSI on EntelliGuard TU Trip Units in ANSI WavePro Circuit Breakers
16	ArcWatch I-ZSI on EntelliGuard TU Trip Units in ANSI/UL 1066 EntelliGuard G Circuit Breakers
17	ArcWatch I-ZSI on EntelliGuard TU Trip Units in UL489 EntelliGuard G Circuit Breakers
18	ArcWatch I-ZSI on Spectra microEntelliGuard Molded Case Circuit Breakers (MCCBs)

---

## Trademarks

Spectra Series® Switchboards  
 EntelliGuard® G  
 EntelliGuard® TU  
 microEntelliGuard™  
 Record Plus® Circuit Breakers  
 WavePro™ Circuit Breakers  
 ArcWatch™  
 Tmax® XT  
 Emax® 2

---

## Warranty

This document is based on information available at the time of its publication. While efforts have been made to ensure accuracy, the information contained herein does not cover all details or variations in hardware and software, nor does it provide for every possible contingency in connection with installation, operation, and maintenance. Features may be described herein that are not present in all hardware and software systems. ABB assumes no obligation of notice to holders of this document with respect to changes subsequently made. ABB makes no representation or warranty, expressed, implied, or statutory, with respect to, and assumes no responsibility for the accuracy, completeness, sufficiency, or usefulness of the information contained herein. No warranties of merchantability or fitness for purpose shall apply.

Contact your local sales office if further information is required concerning any aspect of system operation or maintenance.



Scan this QR code to  
 learn more about  
 Selective Coordination.

## Introduction

ArcWatch is a set of ABB technologies, WaveForm Recognition (WFR) and Instantaneous Zone Selective Interlocking (I-ZSI) which, when used in combination with one another allow system design that does not require compromise between instantaneous protection from arcing faults and full (.01 Second) selective coordination. Using these technologies, ArcWatch can reduce incident energy to less than 8 cal/cm<sup>2</sup> in.

**WFR** provides ArcWatch protection and coordination between a circuit breaker equipped with an EntelliGuard family trip unit and a downstream current limiting device (Record Plus, Spectra, TEY-type MCCBs for example). WFR allows EntelliGuard family trip units to recognize the action of a current limiting device downstream. Faults that are already being acted upon by a downstream limiter do not require action; faults that aren't require action. WFR directs the selective response, depending on the location of the fault.

**I-ZSI** is used to provide ArcWatch protection and coordination between multiple circuit breakers equipped with EntelliGuard family trip units. A simple, ultra-fast acting signal, transmitted between electronic trip units, communicates the fault location, determines which circuit breaker will respond to a fault, and which circuit breakers remain closed.

ArcWatch technology embedded in specific low-voltage ABB trip units and circuit breakers allows circuit breakers to be set for maximum arc flash protection without sacrificing selective coordination. Setting the instantaneous pick-up value sufficiently below the predicted arcing current permits the circuit breaker to clear arcing faults using the circuit breaker's fastest speed. Traditionally, lower pick-up settings lead to reduced selective coordination. ArcWatch solves this dilemma by maintaining selective operation in the instantaneous region even when the time current curves overlap.

These technologies with full-time, always on arc flash mitigation and full selective coordination are ArcWatch.

The following tables list the instantaneous selectivity capability of various ABB circuit breakers. In many cases, selectivity may exceed the selectivity determined by traditional time-current curve analysis. The traditional time-current curves, plotted in Figure 1, demonstrate that the 100A and 1600A circuit breakers shown are fully selective up to ~21,500A RMS. However, other analytical techniques and high current testing have demonstrated that these two circuit breakers are selective to a much higher value, 65,000A. The higher values available with many overcurrent devices will be shown on the tables in this reference publication, as well as some values determined by traditional curve overlay.

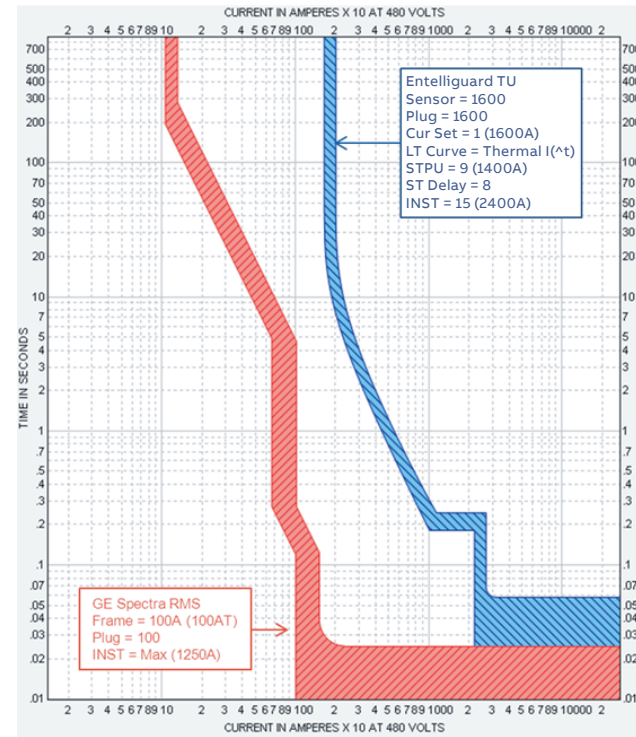

Figure 1: How tables are derived

Circuit breaker mechanisms employ multiple means to open and latch contacts. Some of the mechanisms are very sensitive to instantaneous peak currents. Other mechanisms may be more sensitive to energy, rate of change of current, etc. Some techniques, like ArcWatch, take into account waveform shape and many use combinations of these mechanisms. The different operating mechanisms used and their respective interactions are considered when analyzing system selectivity. Traditional time-current curve based coordination studies provide a very conservative analytical method for determining selectivity and ignore the impact of the various circuit breaker operating mechanism designs.

The selectivity tables in this publication were derived through rigorous analytical techniques, extensive testing, and Six Sigma methodology. The testing was performed using a protocol similar to that described in UL 489 (Standard for Molded Case Circuit Breakers) for series ratings. Testing and analysis was performed for a range of fault magnitudes, closing angles and X/R ratios.

## ASSUMPTIONS

- Fault values are expressed in 60 Hz RMS.
- Selectivity short circuit values are valid at the voltage described and any lower voltage. Selectivity at voltages higher than specifically noted is not implied in these tables.
- Selectivity values for paired circuit breakers are valid for X/R ratios equal to, or less than, those for which the circuit breakers were tested or analyzed. A fault X/R ratio higher than the test X/R ratio will require that the selectivity be de-rated by the ratio of the prospective peak currents. A table of X/R ratios, Power Factors, and expected peak currents is provided (see Table 1). These de-rating methods are the same as those used to de-rate the interrupting rating of any overcurrent protection device whose test X/R ratio is less than the X/R ratio of the available fault current where the device is applied.
- For devices equipped with any of the EntelliGuard series of trip units, the EntelliGuard TU trip unit (ETU,) or the microEntelliGuard Trip Unit (MET,) selectivity is determined by the instantaneous settings on the trip unit. Table 3 illustrates selectivity levels possible using ETU and MET. Tables 6 through 11 illustrate enhanced selectivity possible using the I-ZSI capabilities of the EntelliGuard series trip units.
- For devices not equipped with ETU or MET, the values in the tables represent instantaneous selectivity based on both the upstream and downstream circuit breaker Instantaneous Overcurrent (IOC) being set at the highest possible setting. Where the downstream circuit breaker has an adjustable trip, the setting may be adjusted lower without adverse impact on selectivity. (Unless otherwise indicated, the upstream breaker IOC setting must remain at maximum to achieve the listed selectivity).

## CONSIDERATIONS AND CAUTIONARY NOTES REGARDING IMPLEMENTATION OF INSTANTANEOUS SELECTIVITY

Most industry standards, and good engineering practice, indicate that selectivity is desirable in power distribution systems to maximize system reliability. System designers must weigh selectivity needs against other important system considerations, such as safety, operational reliability, feasibility, efficiency, cost, and size. The National Electrical Code (NEC) defines minimum performance requirements for construction. Designers should consider other factors that may or may not be addressed by the NEC. They should be aware that systems designed for high levels of selectivity may lead to higher arc flash energy, reduced operator and maintenance safety, higher installation costs, and larger equipment or conductors. The use of ArcWatch and other technologies help balance the compromises between arc flash risk and selectivity, the consequences of these risks should be understood.

Traditional time-current curve based analysis must still be used to make sure that long time, short time phase overcurrent and ground fault protection devices are selectively coordinated.

These tables provide guidance on circuit breaker selectivity where the instantaneous clearing times shown on traditional-time-current curves overlap.

## HOW TO FIND AND READ VALUES IN THE TABLES

Before using these tables, the user should have the system one-line diagram, complete with system voltages and available fault currents. The capability for instantaneous selectivity of a particular circuit breaker pair may be dependent on trip setting, rating plug, the circuit breaker's sensor, or the circuit breaker's frame size. The tables will indicate which parameter in the device drives its selective capability.

The Selectivity Tables are organized with upstream devices across the top of the tables (in **boldface type**), and downstream devices in columns on the left.

In tables 3 and 3a, the column titled "Instantaneous Setting Must Be Greater Than" shows the minimum instantaneous pickup, in amps, (on the upstream device) that will provide the selectivity shown with the corresponding downstream device. Table 4 illustrates the maximum possible pickup settings for typical upstream devices equipped with the ETU or MET.

Tables 5, 5a and 5b, arranged the same way, shows the selectivity of devices not equipped with ETU or MET, including current limiting circuit breakers. The value at the intersection of a row and column defines the maximum instantaneous current selectivity capability of the paired devices.

Tables 6 through 11 are also arranged with upstream devices across the top of the tables and downstream devices in the left column. The intersection of a row and column define the maximum possible selectivity of that pair of devices using ArcWatch I-ZSI.

For combinations not shown in the tables or where a table value is blank, the selectivity between the pair can be determined by curve overlay.

Often selectivity may be improved by using a larger upstream device or a circuit breaker with greater adjustability. Downstream selectivity may be improved by using a device with greater current limiting characteristics.

## SYSTEMS WITH MORE THAN TWO CIRCUIT BREAKERS

The analysis used to produce the tables allows three or more devices to be combined. Figure 2 represents a system composed of three circuit breakers defined as devices A, B, and C. The devices are applied at three different fault current values. Circuit breaker A and circuit breaker B need to be selective to 30kA, circuit breaker B and circuit breaker C need to be selective to 13kA. If these two requirements are fulfilled then circuit breakers A and C will also be selective. Note that the fault current value at the first circuit breaker is important to determine the short circuit rating required for that device; however, **it is the available fault current at the downstream circuit breaker that determines the selectivity need.**



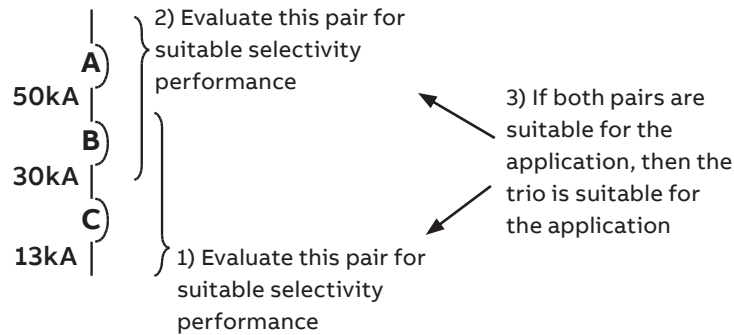

Figure 2: Multiple circuit breaker selectivity

### THROUGH TRANSFORMER SELECTIVITY

Breakers serving a transformer primary and secondary are an example of a circuit where all overcurrent devices do not need to be completely selective to assure reliable system selectivity. Figure 3 shows a simplified system with panel main, a transformer primary main fed from that bus, a 75kVA transformer, a 250A secondary main, and some 120/208V circuits in the downstream panel.

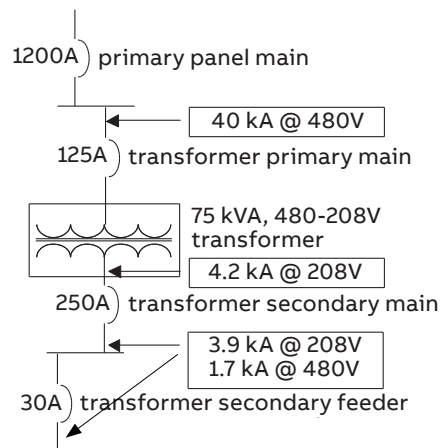

Figure 3: Through transformer selectivity

For the example shown in Figure 3, the 125A transformer primary main should be selective with the 1200A panel main. Selectivity would be required to the fault current value at the 125A device, or 40kAIC (kA Interrupting Current). The 125A primary main and the 250A secondary main need not be selective with each other. (Opening of either device has the same effect on power continuity at the secondary loads). The 250A secondary main should however be selective with the 1200A primary panel main for the maximum available secondary fault current. The secondary fault current is limited by the transformer impedance. The secondary fault current as seen by the primary circuit is further limited by the transformer ratio. In this example, the calculated, bolted three-phase fault current at the transformer's secondary terminals is 4.2kAIC. At the secondary panel, the fault current is 3.9kAIC due to the secondary cable impedance. Selectivity between the 30A feeder and the 250A secondary main is required. A maximum fault current of 3.9kA below the secondary feeder defines the selectivity requirement for that pair of devices. For a 480/208V, delta - wye transformer, the transformer ratio is 2.31:1. The 3.9kA available fault current divided by the transformer ratio is  $(3.9\text{kA}/2.31) = 1.7\text{kA}$ . Therefore, the 30A secondary feeder and the transformer primary main need to be selective to 1.7kAIC.

### ACCOUNTING FOR X/R RATIOS GREATER THAN TEST RATIOS

Circuit breakers are tested at different X/R ratios depending on RMS value of the test currents. The following are the test currents and power factors used during UL 489 testing, and the corresponding X/R-ratios, and the Peak to RMS current ratios. These are the same values used for the selectivity tables:

- < 10,000A RMS – PF = 50%; X/R = 1.732, Peak/RMS = 1.694
- >10,000 – 20,000A RMS – PF = 30%; X/R = 3.180, Peak/RMS = 1.978
- >20,000A RMS – PF = 20%; X/R = 4.899, Peak/RMS = 2.183

A fault current of 60,000A at an X/R ratio of 7 exceeds the standard X/R value. Because of this, the actual peak current magnitude is larger than it would be for the tested X/R of 4.899. For selectivity analysis purposes, the current should be adjusted as follows:

$$60,000\text{A} \times (2.336/2.183) \sim 64,200\text{A}$$

Where:

- 60,000 = base RMS fault current value
- 7 = X/R ratio of the calculated fault current
- 2.183 = peak current factor for a fault current with an X/R ratio of 4.9 (see Table 1)
- 2.336 = peak current factor for a fault current with an X/R ratio of 7 (see Table 1)

Table 1: X/R ratios at test ranges

Test Ranges	Power Factor	X/R Ratio	Maximum Peak
	4	24.9790	2.663
	5	19.9740	2.625
	6	16.6230	2.589
	7	14.2510	2.554
	8	12.4600	2.520
	8.5	11.7230	2.504
	9	11.0660	2.487
	10	9.9501	2.455
	11	9.0354	2.424
	12	8.2733	2.394
	13	7.6271	2.364
	14	7.0721	2.336
	15	6.5912	2.309
	16	6.1695	2.282
	17	5.7967	2.256
	18	5.4649	2.231
	19	5.1672	2.207
>20kA	20	4.8990	2.183
	21	4.6557	2.160
	22	4.4341	2.138
	23	4.2313	2.110
	24	4.0450	2.095
	25	3.8730	2.074
	26	3.7138	2.054
	27	3.5661	2.034
	28	3.4286	2.015
	29	3.3001	1.996
≤20kA, >10kA	30	3.1798	1.978
	31	3.0669	1.960
	32	2.9608	1.943
	33	2.8606	1.926
	34	2.7660	1.910
	35	2.6764	1.894
	36	2.5916	1.878
	37	2.5109	1.863
	38	2.4341	1.848
	39	2.3611	1.833
	40	2.2913	1.819
	41	2.2246	1.805
	42	2.1608	1.791
	43	2.0996	1.778
	44	2.0409	1.765
	45	1.9845	1.753
	46	1.9303	1.740
	47	1.8780	1.728
	48	1.8277	1.716
	49	1.7791	1.705
≤10kA	50	1.7321	1.694

## CIRCUIT BREAKER TYPES

ABB offers several types of circuit breakers with different adjustment and selectivity capabilities. They are broadly described in this section.

EntelliGuard® TU trip unit and Spectra RMS allow instantaneous trip to be adjusted as a multiple of the rating plug Ampacity. The maximum adjustment may be limited by the frame. For Record Plus and Spectra with microEntelliGuard, the instantaneous trip is adjusted as a multiple of the current sensor.

### ANSI /UL 1066 Circuit Breakers with Fully Adjustable Trips

ANSI circuit breakers are those designed and tested to ANSI C37 standards. ABB ANSI devices are Emax 2, AKR, WavePro®, EntelliGuard and EntelliGuard G ANSI circuit breakers. They are generically called Low Voltage Power Circuit Breakers (LVPCBs), and are listed to UL 1066.

EntelliGuard G ANSI /UL 1066 circuit breakers are available with or without Instantaneous Overcurrent Protection. Some EntelliGuard G ANSI/UL 1066 circuit breakers are equipped with an Instantaneous “Override” at very high fault currents. These override-equipped circuit breakers are selective to the current level at which the override becomes active (85-100kA, depending on frame). This level is referred to as the “Withstand Rating” in the tables.

### UL 489 Circuit Breakers with Fully Adjustable Trips

Insulated Case Circuit Breakers (ICCBs) are listed to UL 489. The tables on pages 7-8 also include UL 489 listed Power Break II and EntelliGuard G circuit breakers with EntelliGuard TU trip units. These always include Long-Time, Short Time, and Instantaneous (LSI) protections, although a user may choose to not implement the S function.

Typically, any circuit breaker with adjustable short time pickup and delay allows for a higher instantaneous pickup adjustment. A higher instantaneous pickup may facilitate higher levels of instantaneous selectivity.

Selectivity limits for these circuit breakers are established based on withstand (EntelliGuard G UL489) or short circuit (Power Break II) ratings.

## Molded Case Circuit Breakers (MCCB)

ABB MCCBs fall into several categories:

### • Thermal-magnetic, Current Limiting \*:

- Record Plus: FB, FC, FD
- Q-Line: THQC/THHQC, THQB/THHQB, THQL / THHQL
- TEY Family: TEY, TEY (F, D, H, L)
- Tmax XT1, XT3
- Formula A1, A2

### • Electronic, Current Limiting \*:

- Adjustable Instantaneous (LI or LIG):
  - Record Plus: FE, FG (with SMR1 or PremEon S Trip Unit)
  - Spectra: SE, SF, SG (Spectra RMS)
- Fully Adjustable (LSI or LSIG)
  - Record Plus: FG (with SMR2 Trip Unit):
  - Spectra: SG (with micro-EntelliGuard Trip Unit)
  - Tmax XT 2, 4, 5, 6 and 7

### • Electronic, Non Current Limiting:

- Adjustable Instantaneous (LI)
  - Spectra: SK
- Fully Adjustable (LSI or LSIG)
  - Spectra: SK (with micro-EntelliGuard Trip Unit)\*\*

---

\* Many MCCBs not labeled or UL Listed as current limiting may be current limiting under some fault conditions. It cannot be assumed that any circuit breaker not labeled current limiting always takes a certain amount of time to clear. Time-current curves may show clearing times in excess of ½ or 1 cycle, but the circuit breaker may clear in less than ½ cycle.

---

\*\* SK with MET included in the tables and examples in this document refer to specifically to “SKS and SKT” versions. These SK MCCBs include extended INST pickup and are the versions recommended for maximum selective coordination

Fully adjustable electronic trips allow setting of the long time pick-up, long time delay, short time pick-up, short time delay, and whether the short time characteristic will have an I<sup>2</sup>T response or not. These electronic trips allow for separate adjustments of instantaneous and ground fault protection.

Current limiting circuit breakers as load side devices will provide greater levels of selectivity if the downstream circuit breaker has a current limiting threshold (the current level at which the circuit breaker becomes current limiting) that is lower than the instantaneous pick-up setting of the circuit breaker above.

## ARCWATCH INSTANTANEOUS ZONE SELECTIVE INTERLOCKING (I-ZSI)

Unique to the EntelliGuard family of trip units is the ability to allow simultaneous and independent ZSI of both the short-time and instantaneous protection functions. Instantaneous protection may be interlocked such that all upstream circuit breakers whose zone includes the fault will shift from instantaneous clearing to a 0.058 second time band (in the case of EntelliGuard G circuit breakers) or 0.067 seconds (for other stored energy circuit breakers). Since it is expected that faults of sufficient magnitude to engage the instantaneous pickup are dangerously high, all upstream ArcWatch interlocked trip units that receive a restraint signal are shifted to the same band. If, for whatever reason, the downstream circuit breaker fails to clear, quick backup protection is provided from upstream devices.

Power Break II ICCBs and Spectra microEntelliGuard MCCBs are capable of sending ArcWatch I-ZSI restraint signals, but cannot be restrained by a received signal. They must therefore be the most downstream breakers in an I-ZSI coordinated set of devices.

The ability to use ArcWatch to shift instantaneous protections allows these circuit breakers to be selective to their full withstand rating while still providing instantaneous protection.

## ARCWATCH WAVEFORM RECOGNITION (WFR)

Waveform Recognition is an exclusive intelligence built into ABB’s EntelliGuard family of trip units. It allows the trip units to “see” the operation of current limiting overcurrent devices downstream. This feature is automatically built into every EntelliGuard series trip unit, whatever circuit breaker (EntelliGuard G, PowerBreak II, Spectra MCCB, or even retrofitted legacy ANSI) it is installed on. This exclusive ArcWatch intelligence allows INST pickups to be adjusted lower than possible on traditional peak-sensing or even RMS-sensing devices, allowing selective coordination with better arc flash performance.



Table 2: Trip unit types

Product Family	UL 489 Molded Case	UL 489 Insulated Case	ANSI C37/UL 1066	Trip Unit Types		ArcWatch Protections	
				Thermal-magnetic (TM) or Electronic with Adjustable INST (LI or LIG)	Adjustable LSIG	I-ZSI	WFR
<b>Spectra</b>	Yes	–	–	Spectra RMS- electronic	Optional micro-EntelliGuard (SG/SK)	Yes (as downstream)	
<b>Record Plus</b>	Yes	–	–	FB, FC -TM	–	No	Yes (as downstream)
		–	–	FE, FG - Electronic SMR1 or PremEon S	Optional – SMR2 (FG only)	No	
<b>EntelliGuard G</b>	–	Yes	Yes	Electronic	EntelliGuard TU	Yes	
<b>PowerBreak II</b>	–	Yes	–	Electronic	EntelliGuard TU	Yes	Yes (as upstream)
<b>WavePro</b>	–	–	Yes	Electronic	EntelliGuard TU	Yes	
<b>Emax 2</b>	–	–	Yes	Electronic	Ekip	No	No
<b>Tmax XT</b>	Yes	–	–	TM	Ekip	No	Yes (as downstream)
<b>Formula</b>	Yes	–	–	TM	–	No	Yes (as downstream)

#### ENTELLIGUARD SERIES TRIP UNITS IN ANSI, POWER BREAK II, AND MOLDED CASE CIRCUIT BREAKERS ; EKIP TRIP UNITS IN ANSI EMAX2 AND TMAX XT MOLDED CASE CIRCUIT BREAKERS

Selectivity between any upstream circuit breaker with an EntelliGuard Series trip unit OR Ekip trip unit and a downstream ABB current limiting circuit breaker is determined by the setting of the upstream EntelliGuard TU /Ekip TU. Tables 3 and 3a on pages 7 and 8 identify the values for ABB's currently produced current limiting molded case circuit breakers. When the upstream trip unit's IOC is set at the value listed in the column labeled "Instantaneous setting must be  $\geq$  " or higher, the pair is selective over the instantaneous range. The table describes how the circuit breaker type limits selectivity. The table applies through 480 volts, except where limited by circuit breaker maximum voltage.

Instantaneous selectivity between a circuit breaker with an EntelliGuard Series trip unit and any non-current limiting circuit breaker may be evaluated via traditional time current curve overlay analysis. If ArcWatch Instantaneous zone selective interlocking is employed, selectivity is limited only by the upstream circuit breaker's withstand or short circuit rating is possible.

Table 3: Circuit breaker type and selectivity limits

Downstream		Upstream					
Frame Designation	Minimum - Maximum Trip	Min. INST <sup>3</sup> Setting (in Amps)	Spectra K (Extended INST SKS/SKT)	PowerBreak II, UL 489	WavePro, AKR, AK, or other ANSI CB without override	EntelliGuard G, UL 489	EntelliGuard G or E <sup>7</sup> , ANSI/UL 1066
Tmax XT5	600A	20,360A	65,000A				
	400A						
	250A						
Tmax XT4	25-250A (TM)/40-250A (Ekip)	9,610A <sup>2</sup>	To short circuit rating <sup>4</sup>				
Tmax XT3	60-225A	9,610A <sup>2</sup>					
Tmax XT2	15-125A (TM)/10-125A (Ekip)	9,610A <sup>1</sup>					
Tmax XT1	15-125A	9,610A <sup>1</sup>					
Sentricity SLC/SLCH	125A (2 pole)	2,500A					
	100A (2 pole)	2,500A					
	60A (2 pole)	2,500A					
	60A (1 pole)	2,500A					
	30A (1 pole)	2,500A					
	15A (1 and 2 pole)	2,500A					
Record Plus FG <sup>6</sup>	175-600A <sup>8</sup>	20,360A	65,000A				
	125-400A						
	80-250A						
Record Plus FE <sup>6</sup>	80-250A	9,610A <sup>1</sup>	To short circuit rating <sup>4</sup>	To short circuit rating <sup>4</sup>	To short circuit rating <sup>4</sup>	To withstand rating <sup>4</sup>	To withstand rating <sup>4</sup>
	45-150A <sup>8</sup>						
	40-125A						
	18-60A						
	8-25A						
Record Plus FB/FC	15-100A	7,110A					
Spectra SG <sup>5</sup>	250-600A (RMS)/112.5-600A (MET) <sup>9</sup>	29,990A	-				
	125-400A (RMS)/75-400A (MET) <sup>9</sup>						
	30-150A (MET) <sup>9</sup>						
Spectra SF	70-250A	11,210A <sup>2</sup>	85,000A				
Spectra SE	110-150A	9,610A <sup>2</sup>	To short circuit rating <sup>4</sup>				
	70-100A						
	40-60A						
	15-30A						
TEYH/TEYL	15-125A	9,610A <sup>1</sup>					
TEY/TEYF	15-100A	9,610A <sup>1</sup>					
THQL/THQB (240V)	15-60A	9,610A <sup>1</sup>					
THHQL/THHQB (240V)	15-60A	9,610A <sup>1</sup>					

**Notes:**

- EntelliGuard TU must employ rating plug of 400A or greater.
- EntelliGuard TU must employ rating plug of 800A or greater.
- Any curve overlap in the INST clearing region of the time-current curve does not represent a lack of selectivity and can be ignored.
- Selectivity cannot exceed the short circuit rating of the minimum between upstream and downstream devices. Selectivity cannot exceed the rating of the minimum between withstand (upstream) and short circuit rating (downstream).
- Min/max ranges of Spectra G shown with standard Spectra RMS trip unit (min rating plug)/with micro-EntelliGuard (min rating plug and min. LTPU setting)
- Min/max ranges for Record Plus FE and FG show with PremEon S trip unit. SMR1 minimum limits differ without affecting upstream selectivity.
- EntelliGuard E used in GE Entellisys switchgear.
- FE 160A IEC, FG 630A IEC
- Minimum rating plugs by frame for MET: 600A frame = 225 plug; 400A frame = 150A plug; 150A frame = 60A plug.

Table 3a: Circuit breaker types and selectivity limits

Downstream		Upstream					
Frame Designation	Minimum-Maximum Trip	Min. INST Setting (in Amps)	Tmax XT7	E <sub>max</sub> 2 1.2, ANSI/UL 1066	E <sub>max</sub> 2 2.2, ANSI/UL 1066	E <sub>max</sub> 2 4.2, ANSI/UL 1066	E <sub>max</sub> 2 6.2, ANSI/UL 1066
Tmax XT6	800	18000A	-				
	600						
Tmax XT5	600	15000A	100,000				
	400						
	250						
Tmax XT4	25-250A(TM)/40-250A (Ekip)	6,000A	100,000				
Tmax XT3	60-225A	6,000A	To short circuit rating <sup>2</sup>				
Tmax XT2	15-125A (TM)/10-125A (Ekip)	4,000A	100,000				
Tmax XT1	15-125A	4,000A	To short circuit rating <sup>2</sup>				
Formula A2 (240V)	125-250A	6,000A					
Sentricity SLC (240V)	15-125A	2,500A					
Sentricity SLCH (240V)	15-125A	2,500A					
Record Plus FG <sup>4</sup>	175-600A <sup>5</sup>	15,000A	100,000				
	125-400A						
	80-250A						
Record Plus FE <sup>4</sup>	80-250A	6,000A	To short circuit rating <sup>2</sup>	To withstand rating <sup>2</sup>	To withstand rating <sup>2</sup>	To withstand rating <sup>2</sup>	To withstand rating <sup>2</sup>
	45-150A <sup>5</sup>						
	40-125A						
	18-60A						
	8-25A						
Record Plus FB/FC	15-100A	6,000A	65,000				
Spectra SG <sup>3</sup>	250-600A (RMS)/112.5-600A (MET) <sup>6</sup>	18000A	-				
	125-400A (RMS)/75-400A (MET) <sup>6</sup>						
	30-150A (MET) <sup>6</sup>						
Spectra SF	70-250A	8,000A	To short circuit rating <sup>2</sup>				
Spectra SE	110-150A	4,000A					
	70-100A						
	40-60A						
	15-30A						
TEYL/TEYH	15-125A	4,000A					
TEYF/TEY	15-100A	4,000A					
THQL/THQB (240V)	15-125A	4,000A					
THHQL/THHQB (240V)	15-125A	4,000A					

## Notes:

- Any curve overlap in the INST clearing region of the time-current curve does not represent a lack of selectivity and can be ignored.
- Selectivity cannot exceed the short circuit rating of the minimum between upstream and downstream devices. Selectivity cannot exceed the rating of the minimum between withstand (upstream) and short circuit rating (downstream).
- Min/max ranges of Spectra G shown with standard Spectra RMS trip unit (min rating plug)/with micro-EntelliGuard (min rating plug and min. LTPU setting)
- Min/max ranges for Record Plus FE and FG show with PremEon S trip unit. SMR1 minimum limits differ without affecting upstream selectivity. 3 Pole only.
- FE 160A IEC, FG 630A IEC
- Minimum rating plugs by frame for MET: 600A frame = 225 plug; 400A frame = 150A plug; 150A frame = 60A plug.

### SELECTIVITY WITH ENTELLIGUARD TU TRIP UNITS IN ANSI, POWER BREAK II, AND MOLDED CASE CIRCUIT BREAKERS

The table below identifies maximum instantaneous pickup multipliers for various types and sizes of ABB circuit breakers. The lower part of the table identifies the maximum instantaneous pickup (in amperes) for various circuit breaker, sensor, and rating plug combinations. If you compare this value with the values in the third column of the preceding table, you can tell if a pair of circuit breakers can be selective.

Table 4: Maximum instantaneous pickup for EntelliGuard family trip units in various circuit breakers types

Downstream device with EntelliGuard TU Trip Unit	Selective Spectra K (SKS and SKT) Max Instantaneous <sup>1</sup> in X	Power Break II, UL 489 CB	Legacy WavePro or AKR, ANSI CB	EntelliGuard G, ANSI/UL (Standard INST)	EntelliGuard G, ANSI (Extended INST)
800A frame	25.5	15	15	15	30
1000A frame	20.5	–	–	–	–
1200A frame	17	–	–	–	–
1600A frame	–	15	15	15	30
2000A frame	–	15	15	15	30
3000A frame	–	13	–	15	30
3200A frame	–	–	13	15	30
4000A frame	–	10	10	15	23
5000A frame	–	–	7	15	19
6000A frame (UL 489 only)	–	–	–	15	–
	Amperes per above multipliers				
800A frame, 800A plug	20,400	12,000	12,000	12,000	24,000
1000A frame/sensor <sup>2</sup>	20,500	–	–	–	–
1200A frame/sensor <sup>2</sup>	20,400	–	–	–	–
1600A frame, 1600A plug	–	24,000	24,000	24,000	48,000
2000A frame, 2000A plug	–	30,000	30,000	30,000	60,000
3000A frame, 3000A plug	–	39,000	–	45,000	90,000
3200A frame, 3200A plug	–	–	41,600	48,000	96,000
4000A frame, 4000A plug	–	40,000	40,000	60,000	92,000
5000A frame, 5000A plug	–	–	35,000	75,000	95,000
6000A frame, 6000A plug	–	–	–	90,000	–

**Notes:**

1. Frame determines maximum instantaneous pickup (X) for PowerBreak II, WavePro, and Selective Spectra K. Plug/Icw ratio determines maximum possible for EntelliGuard G. EntelliGuard G values shown are maximum withstand tiers.
2. Spectra K only.

For Power Break II, WavePro and EntelliGuard G maximum instantaneous is a multiple of rating plug; the above values for those breakers may be lower if a smaller rating plug than maximum for frame is used. For Selective Spectra K, maximum instantaneous is a multiple of frame. In Power Break II, WavePro, and Selective Spectra K the maximum instantaneous multiplier is limited by frame rating. In EntelliGuard G, the maximum instantaneous X may be limited by withstand). The amperes listed above, multiplied by 0.9, provide maximum selectivity above non-current limiting circuit breakers if instantaneous is adjusted to maximum and no zone selective interlocking is used.

**SELECTIVITY WITH RECORD PLUS FE AND FG**

The table below identifies maximum selectivity between Record Plus upstream circuit breakers and typical downstream branch devices. The table assumes the INST pickup setting of the upstream device adjusted to its maximum. Downstream devices (where adjustable) may be adjusted to lower INST pickup settings without affecting the maximum selectivity of the pair. The table applies through 480 volts, as limited by circuit breaker maximum voltage.

Table 5: Selectivity for typical 600A and smaller combinations

Downstream			Upstream				
	Amperes	Poles	Record Plus FG			Record Plus FE	
			600	400	250	250	150 & 125
<b>Record Plus FE Electronic</b>	20-250	2 and 3	100,000	–	–	–	–
<b>Record Plus FB/FC</b>	15-100	1, 2 and 3	65,000	65,000	65,000	–	–
<b>TEYL</b>	80-125	2 and 3	65,000	65,000	65,000	–	–
	35-70	1, 2 and 3	65,000	65,000	65,000	–	–
	15-30	2 and 3	65,000	65,000	65,000	–	–
	15-30	1	65,000	65,000	65,000	14,000	10,000
<b>TEYH</b>	80-125	2 and 3	35,000	35,000	35,000	–	–
	35-70	1, 2 and 3	35,000	35,000	35,000	–	–
	15-30	2 and 3	35,000	35,000	35,000	–	–
	15-30	1	35,000	35,000	35,000	14,000	10,000
<b>TEYF</b>	35-100	1, 2 and 3	14,000	14,000	14,000	–	–
	15-30	2 and 3	14,000	14,000	14,000	–	–
	15-30	1P	14,000	14,000	14,000	14,000	10,000
<b>TEY</b>	70-100	1, 2 and 3	6,000	4,000	2,500	–	–
	35-60	2 and 3	10,000	10,000	2,500	–	–
	15-30	2 and 3	14,000	14,000	14,000	–	–
	35-60	1	10,000	10,000	2,500	–	–
	15-30	1	14,000	14,000	14,000	10,000	10,000
<b>THQC/THQL/THQB</b>	125	2	10,000	10,000	2,500	–	–
	70-100	1, 2 and 3	10,000	10,000	2,500	–	–
	35-60	2 and 3	10,000	10,000	10,000	4,000	4,000
	15-30	2 and 3	10,000	10,000	10,000	6,000	6,000
	35-60	1	10,000	10,000	10,000	–	–
	15-30	1	10,000	10,000	10,000	10,000	10,000
<b>THHQC/THHQL/THHQB</b>	125	2	22,000	22,000	2,500	–	–
	70-100	1, 2 and 3	22,000	22,000	2,500	–	–
	35-60	2 and 3	22,000	22,000	10,000	4,000	4,000
	15-30	2 and 3	22,000	22,000	22,000	6,000	6,000
	35-60	1	22,000	22,000	10,000	–	–
	15-30	1	22,000	22,000	22,000	14,000	14,000

**SELECTIVITY WITH TMAX XT**

The table below identifies the maximum selectivity between Tmax XT upstream circuit breakers and Tmax XT downstream branch devices. The table assumes the INST pickup setting of the upstream device is adjusted to its maximum. Downstream devices (where adjustable) may be adjusted to lower INST pickup settings without affecting the maximum selectivity of the pair. The table applies through 480 volts, as limited by circuit breaker maximum voltage.

**Table 5a: Selectivity for typical 800A and smaller combinations**

Downstream			Upstream						
	Amperes	Poles	Tmax XT6 (Ekip)		Tmax XT5 (Ekip)			Tmax XT4 (Ekip)	Tmax XT2 (Ekip)
			800	600	600	400	250	250	125
<b>Tmax XT4</b>	250	2, 3, and 4	65,000	65,000	100,000 <sup>1</sup>	100,000 <sup>1</sup>	–	–	–
<b>Tmax XT3</b>	225	2, 3, and 4	–	–	35,000 <sup>1</sup>	–	–	–	–
<b>Tmax XT2</b>	125	2, 3, and 4	65,000	65,000	100,000 <sup>1</sup>	100,000 <sup>1</sup>	100,000 <sup>1</sup>	–	–
<b>Tmax XT1</b>	125	2, 3, and 4	–	–	65,000 <sup>1</sup>	65,000 <sup>1</sup>	65,000 <sup>1</sup>	–	–
<b>Formula A2 (240V)</b>	250	2 and 3	25,000	25,000	25,000	25,000	–	–	–
	125	2 and 3	25,000	25,000	25,000	25,000	–	–	–
<b>Sentricity SLC (240V)</b>	125	2	10,000	10,000	10,000	10,000	10,000	10,000	–
	100	2	10,000	10,000	10,000	10,000	10,000	10,000	–
	60	1 and 2	10,000	10,000	10,000	10,000	10,000	10,000	10,000
	30	1 and 2	10,000	10,000	10,000	10,000	10,000	10,000	10,000
	15	1 and 2	10,000	10,000	10,000	10,000	10,000	10,000	10,000
<b>Sentricity SLCH (240V)</b>	125	2	22,000	22,000	22,000	22,000	22,000	22,000	–
	100	2	22,000	22,000	22,000	22,000	22,000	22,000	–
	60	1 and 2	22,000	22,000	22,000	22,000	22,000	22,000	22,000
	30	1 and 2	22,000	22,000	22,000	22,000	22,000	22,000	22,000
	15	1 and 2	22,000	22,000	22,000	22,000	22,000	22,000	22,000

**Notes:**

1. Shown selectivity is valid with Ekip DIP version of the trip unit only. Please contact ABB for reduced selectivity ratings with Ekip Touch/High Touch trip unit.



**SELECTIVITY WITH TMAX XT**

The table below identifies the maximum selectivity between Tmax XT upstream circuit breakers and legacy ABB downstream branch devices. The table assumes the INST pickup setting of the upstream device is adjusted to its maximum. Downstream devices (where adjustable) may be adjusted to lower INST pickup settings without affecting the maximum selectivity of the pair. The table applies through 480 volts, as limited by circuit breaker maximum voltage.

**Table 5b: Selectivity for typical 800A and smaller combinations**

Downstream	Amperes      Poles		Upstream						
			Tmax XT6 (Ekip)		Tmax XT5 (Ekip)			Tmax XT4 (Ekip)	Tmax XT3 (TM)
			800	600	600	400	250	250	225
<b>Record Plus FE</b>	20-250	2 and 3	65,000	65,000	100,000 <sup>1</sup>	–	–	–	–
<b>Record Plus FB/FC</b>	15-100	1, 2, and 3	65,000	65,000	65,000 <sup>1</sup>	65,000 <sup>1</sup>	65,000 <sup>1</sup>	–	–
<b>TEYL</b>	80-125	2 and 3	50,000	50,000	65,000 <sup>1</sup>	65,000 <sup>1</sup>	65,000 <sup>1</sup>	–	–
	35-70	1, 2, and 3	50,000	50,000	65,000 <sup>1</sup>	65,000 <sup>1</sup>	65,000 <sup>1</sup>	–	–
	15-30	2 and 3	50,000	50,000	65,000 <sup>1</sup>	65,000 <sup>1</sup>	65,000 <sup>1</sup>	–	–
	15-30	1	50,000	50,000	65,000 <sup>1</sup>	65,000 <sup>1</sup>	65,000 <sup>1</sup>	4,000	–
<b>TEYH</b>	80-125	2 and 3	35,000	35,000	35,000	35,000	35,000	–	–
	35-70	1, 2, and 3	35,000	35,000	35,000	35,000	35,000	–	–
	15-30	2 and 3	35,000	35,000	35,000	35,000	35,000	–	–
	15-30	1	35,000	35,000	35,000	35,000	35,000	4,000	–
<b>TEYF</b>	35-100	1, 2, and 3	14,000	14,000	14,000	14,000	14,000	–	–
	15-30	2 and 3	14,000	14,000	14,000	14,000	14,000	–	–
	15-30	1	14,000	14,000	14,000	14,000	14,000	4,000	–
<b>TEY</b>	70-100	1, 2, and 3	14,000	14,000	14,000	14,000	14,000	–	–
	35-60	2 and 3	14,000	14,000	14,000	14,000	14,000	–	–
	15-30	2 and 3	14,000	14,000	14,000	14,000	14,000	–	–
	36-60	1	14,000	14,000	14,000	14,000	14,000	–	–
	15-30	1	14,000	14,000	14,000	14,000	14,000	4,000 (15A only)	–
<b>THQC/THQL/THQB</b>	125	2	10,000	10,000	10,000	10,000	10,000	–	–
	70-100	1, 2, and 3	10,000	10,000	10,000	10,000	10,000	–	–
	35-60	2 and 3	10,000	10,000	10,000	10,000	10,000	–	–
	15-30	2 and 3	10,000	10,000	10,000	10,000	10,000	4,000 (15A 3P only)	–
	35-60	1	10,000	10,000	10,000	10,000	10,000	4,000	–
	15-30	1	10,000	10,000	10,000	10,000	10,000	4,000	9,000
<b>THQQC/THHQL/THHQB</b>	125	2	22,000	22,000	22,000	22,000	22,000	–	–
	70-100	1, 2, and 3	22,000	22,000	22,000	22,000	22,000	–	–
	35-60	2 and 3	22,000	22,000	22,000	22,000	22,000	–	–
	15-30	2 and 3	22,000	22,000	22,000	22,000	22,000	4,000 (15A 3P only)	–
	35-60	1	22,000	22,000	22,000	22,000	22,000	4,000	–
	15-30	1	22,000	22,000	22,000	22,000	22,000	4,000	9,000
<b>Spectra F</b>	70-250	2 and 3	–	–	100,000 <sup>1</sup>	100,000 <sup>1</sup>	–	–	–
<b>Spectra E</b>	15-150	2 and 3	–	–	100,000 <sup>1</sup>	100,000 <sup>1</sup>	100,000 <sup>1</sup>	–	–

**Notes:**

1. Shown selectivity is valid with Ekip DIP version of the trip unit only. Please contact ABB for reduced selectivity ratings with Ekip Touch/High Touch trip unit.

Figure 4: Selectivity using ArcWatch I-ZSI and WFR tested breaker pairs with switchboard service entrance

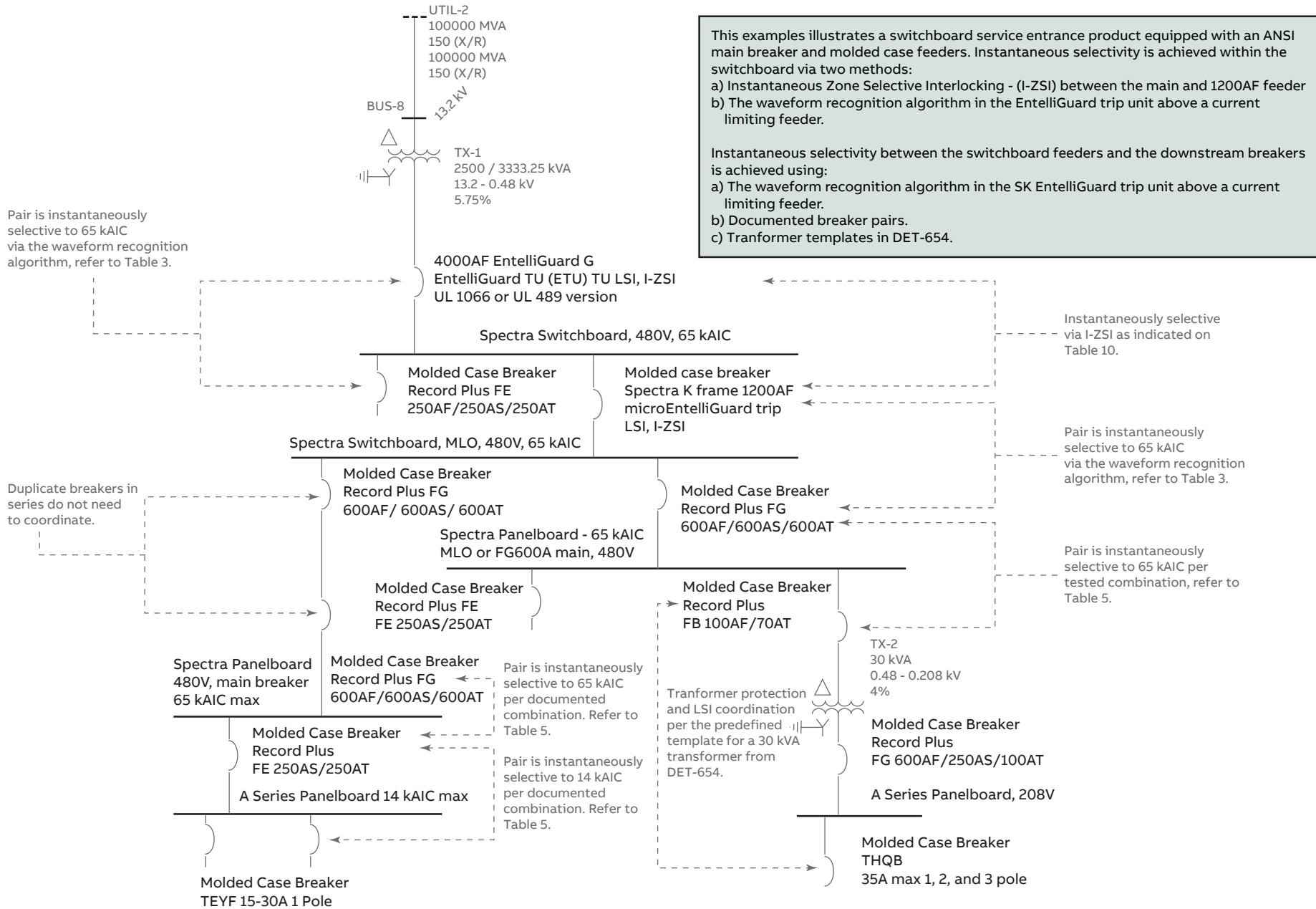
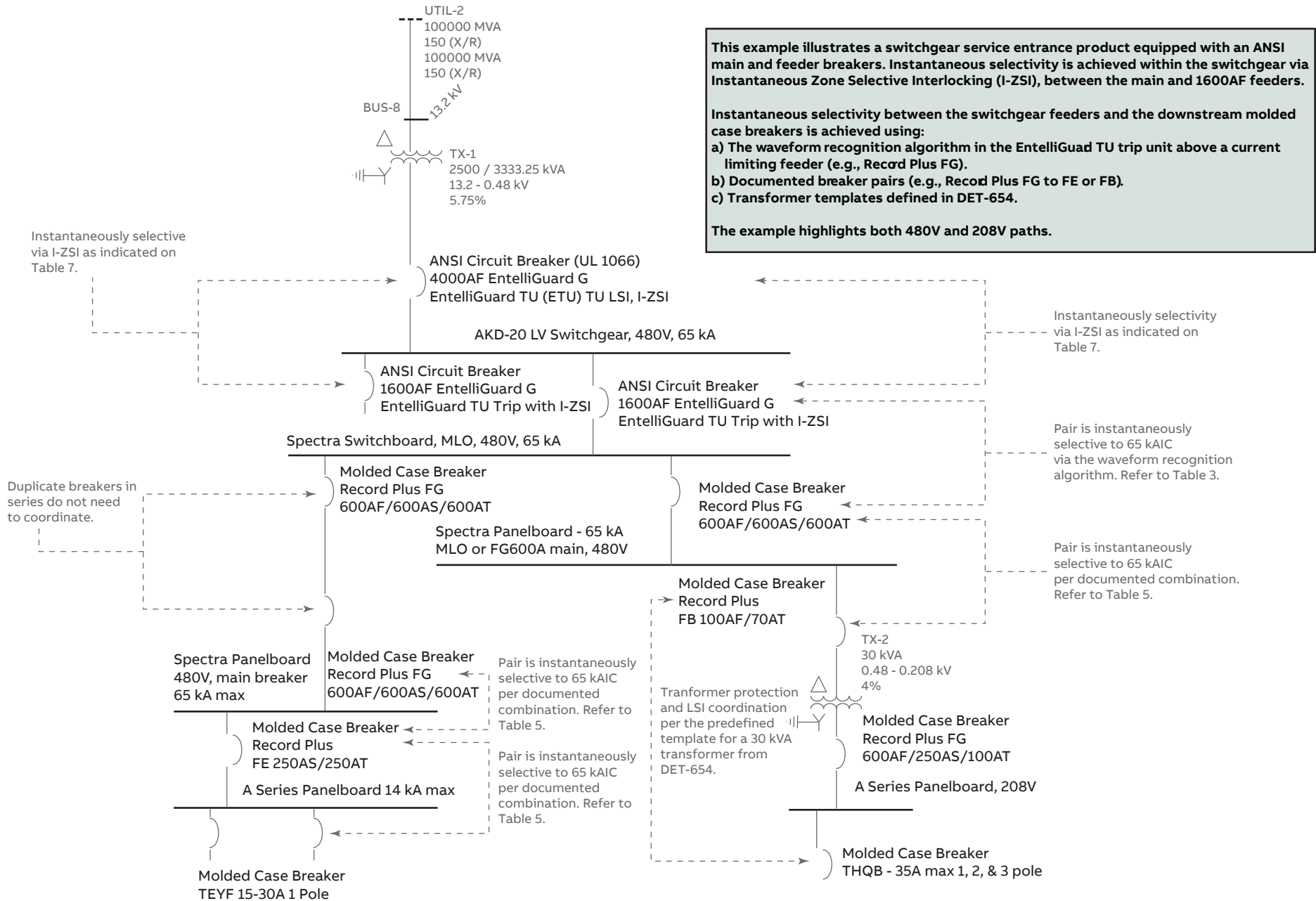

Figure 5: Selectivity using ArcWatch I-ZSI and WFR tested breaker pairs with switchgear service entrance, 480V and 208V paths



**ARCWATCH I-ZSI ON ENTELLIGUARD TU TRIP UNITS IN ANSI WAVEPRO CIRCUIT BREAKERS**

Maximum instantaneous selectivity that may be achieved using Instantaneous Zone Selective Interlocking between these WavePro Low Voltage Power circuit breakers. Limited by short circuit rating of downstream device or upstream device.

**Table 6: Selectivity with EntelliGuard TU in ANSI WavePro circuit breakers using I-ZSI**

Downstream	Upstream													
	WavePro ANSI Low Voltage Power CB. Long Time Curves, Short Time pickup, and instantaneous pickup must be adjusted per TCC													
WavePro	WPS-08	WPH-08	WPX-08	WPS-16	WPH-16	WPX-16	WPS-20	WPS-32	WPH-32	WPX-32	WPS-40	WPX-40	WPS-50	WPX-50
WPS-08	30	30	30	30	30	30	30	30	30	30	30	30	30	30
WPH-08	30	42	42	30	42	42	42	42	42	42	42	42	42	42
WPX-08	30	42	65	30	42	65	65	65	65	65	65	65	65	65
WPS-16	-	-	-	30	30	30	30	30	30	30	30	30	30	30
WPH-16	-	-	-	30	42	42	42	42	42	42	42	42	42	42
WPX-16	-	-	-	30	42	65	65	65	65	65	65	65	65	65
WPS-20	-	-	-	-	-	-	65	65	65	65	65	65	65	65
WPS-32	-	-	-	-	-	-	-	65	65	65	65	65	65	65
WPH-32	-	-	-	-	-	-	-	65	85	85	85	85	85	85
WPX-32	-	-	-	-	-	-	-	65	85	100	85	100	85	100
WPS-40	-	-	-	-	-	-	-	-	-	-	85	85	85	85
WPX-40	-	-	-	-	-	-	-	-	-	-	85	100	85	100
WPS-50	-	-	-	-	-	-	-	-	-	-	-	-	85	85
WPX-50	-	-	-	-	-	-	-	-	-	-	-	-	85	100

**Notes:**  
Selectivity values are shown in kA.

**ARCWATCH I-ZSI ON ENTELLIGUARD TU TRIP UNITS IN ANSI ENTELLIGUARD G CIRCUIT BREAKERS**

Maximum instantaneous selectivity that may be achieved using Instantaneous Zone Selective Interlocking between these EntelliGuard ANSI (VL 1066) circuit breakers. Limited by short circuit rating of downstream device and withstand rating of upstream device.

**Table 7: Selectivity with EntelliGuard TU Trip Units in ANSI EntelliGuard G circuit breakers using I-ZSI**

Downstream		Upstream																						
EntelliGuard G, ANSI CB		EntelliGuard G ANSI / UL1066 Low Voltage Power CB. Long Time Curves, Short Time pickup, and Instantaneous pickup must be adjusted per TCC																						
Frame and Sensor	AIC Tier, at 240 & 480V	800A				1600A				2000A				3200A				4000A				5000A		
		N-65kA	H-85kA	E-85kA	M-100kA	N-65kA	H-85kA	E-85kA	M-100kA	N-65kA	H-85kA	E-85kA	M-100kA	N-65kA	E-85kA	M-100kA	B-100kA	L-150kA	M-100kA	B-100kA	L-150kA	M-100kA	B-100kA	L-150kA
800A	N-65kA	65	65	65	65	65	65	65	65	65	65	65	65	65	65	65	65	65	65	65	65	65	65	65
800A	H-85kA	65	65	85	85	65	65	85	85	65	65	85	85	65	85	85	85	85	85	85	85	85	85	85
800A	E-85kA	65	65	85	85	65	65	85	85	65	65	85	85	65	85	85	85	85	85	85	85	85	85	85
800A	M-100kA	65	65	85	85	65	65	85	85	65	65	85	85	65	85	85	100	100	85	100	100	85	100	100
1600A	N-65kA	-	-	-	-	65	65	65	65	65	65	65	65	65	65	65	65	65	65	65	65	65	65	65
1600A	H-85kA	-	-	-	-	65	65	85	85	65	65	85	85	65	85	85	85	85	85	85	85	85	85	85
1600A	E-85kA	-	-	-	-	65	65	85	85	65	65	85	85	65	85	85	85	85	85	85	85	85	85	85
1600A	M-100kA	-	-	-	-	65	65	85	85	65	65	85	85	65	85	85	100	100	85	100	100	85	100	100
2000A	N-65kA	-	-	-	-	-	-	-	-	65	65	65	65	65	65	65	65	65	65	65	65	65	65	65
2000A	H-85kA	-	-	-	-	-	-	-	-	65	65	85	85	65	85	85	85	85	85	85	85	85	85	85
2000A	E-85kA	-	-	-	-	-	-	-	-	65	65	85	85	65	85	85	85	85	85	85	85	85	85	85
2000A	M-100kA	-	-	-	-	-	-	-	-	65	65	85	85	65	85	85	100	100	85	100	100	85	100	100
3200A	N-65kA	-	-	-	-	-	-	-	-	-	-	-	-	65	65	65	65	65	65	65	65	65	65	65
3200A	E-85kA	-	-	-	-	-	-	-	-	-	-	-	-	65	85	85	85	85	85	85	85	85	85	85
3200A	M-100kA	-	-	-	-	-	-	-	-	-	-	-	-	65	85	85	100	100	85	100	100	85	100	100
3200A	B-100kA	-	-	-	-	-	-	-	-	-	-	-	-	65	85	85	100	100	85	100	100	85	100	100
3200A	L-150kA	-	-	-	-	-	-	-	-	-	-	-	-	65	85	85	100	100	85	100	100	85	100	100
4000A	M-100kA	-	-	-	-	-	-	-	-	-	-	-	-	-	-	-	-	85	100	100	85	100	100	100
4000A	B-100kA	-	-	-	-	-	-	-	-	-	-	-	-	-	-	-	-	85	100	100	85	100	100	100
4000A	L-150kA	-	-	-	-	-	-	-	-	-	-	-	-	-	-	-	-	85	100	100	85	100	100	100
5000A	M-100kA	-	-	-	-	-	-	-	-	-	-	-	-	-	-	-	-	-	-	-	-	85	100	100
5000A	B-100kA	-	-	-	-	-	-	-	-	-	-	-	-	-	-	-	-	-	-	-	-	85	100	100
5000A	L-150kA	-	-	-	-	-	-	-	-	-	-	-	-	-	-	-	-	-	-	-	-	85	100	100

**Notes:**  
Selectivity values are shown in kA.

**ARCWATCH I-ZSI ON ENTELLIGUARD TU TRIP UNITS IN UL489 ENTELLIGUARD G CIRCUIT BREAKERS**

Maximum instantaneous selectivity that may be achieved using Instantaneous Zone Selective Interlocking (I-ZSI) between these EntelliGuard UL circuit breakers. Limited by short circuit rating of downstream device and withstand rating of upstream device.

**Table 8: Selectivity with EntelliGuard TU in EntelliGuard G UL 489 Listed circuit breakers using I-ZSI**

Downstream		Upstream																		
EntelliGuard G, UL, CB		EntelliGuard G UL489 Low Voltage Power CB. Long Time Curves, Short Time pickup, and Instantaneous pickup must be adjusted per TCC																		
Frame and Sensor	AIC Tier, at 240 & 480V	800A	800A	800A	1600A	1600A	1600A	2000A	2000A	2000A	3000A	3000A	3000A	3000A	4000A	4000A	5000A	5000A	6000A	6000A
		N-65kA	H-85kA	M-100kA	N-65kA	H-85kA	M-100kA	N-65kA	H-85kA	M-100kA	N-65kA	H-85kA	M-100kA	L-150kA	M-100kA	L-150kA	M-100kA	L-150kA	M-100kA	L-150kA
800A	N-65kA	42	50	65	42	50	65	42	50	65	42	50	65	65	65	65	65	65	65	65
800A	H-85kA	42	50	65	42	50	85	42	50	65	42	50	65	85	65	85	65	85	65	85
800A	M-100kA	42	50	65	42	50	100	42	50	65	42	50	65	85	65	85	65	85	65	85
1600A	N-65kA	-	-	-	42	50	65	42	50	65	42	50	65	65	65	65	65	65	65	65
1600A	H-85kA	-	-	-	42	50	85	42	50	65	42	50	65	85	65	85	65	85	65	85
1600A	M-100kA	-	-	-	42	50	100	42	50	65	42	50	65	85	65	85	65	85	65	85
2000A	N-65kA	-	-	-	-	-	-	42	50	65	42	50	65	65	65	65	65	65	65	65
2000A	H-85kA	-	-	-	-	-	-	42	50	65	42	50	65	85	65	85	65	85	65	85
2000A	M-100kA	-	-	-	-	-	-	42	50	65	42	50	65	85	65	85	65	85	65	85
3000A	N-65kA	-	-	-	-	-	-	-	-	-	42	50	65	65	65	65	65	65	65	65
3000A	H-85kA	-	-	-	-	-	-	-	-	-	42	50	65	85	65	85	65	85	65	85
3000A	M-100kA	-	-	-	-	-	-	-	-	-	42	50	65	85	65	85	65	85	65	85
3000A	L-150kA	-	-	-	-	-	-	-	-	-	42	50	65	85	65	85	65	85	65	85
4000A	M-100kA	-	-	-	-	-	-	-	-	-	-	-	-	-	65	85	65	85	65	85
4000A	L-150kA	-	-	-	-	-	-	-	-	-	-	-	-	-	65	85	65	85	65	85
5000A	M-100kA	-	-	-	-	-	-	-	-	-	-	-	-	-	-	-	65	85	65	85
5000A	L-150kA	-	-	-	-	-	-	-	-	-	-	-	-	-	-	-	65	85	65	85
6000A	M-100kA	-	-	-	-	-	-	-	-	-	-	-	-	-	-	-	-	-	65	85
6000A	L-150kA	-	-	-	-	-	-	-	-	-	-	-	-	-	-	-	-	-	65	85

**Notes:**  
Selectivity values are shown in kA.



### ARCWATCH I-ZSI ON SPECTRA MICROENTELIGUARD MOLDED CASE CIRCUIT BREAKERS (MCCBs)

The tables that follow show maximum instantaneous selectivity that may be achieved using Instantaneous Zone Selective Interlocking (I-ZSI) between downstream Spectra molded case circuit breakers provided with Instantaneous Zone Selective Interlocking (I-ZSI) and upstream ABB WavePro Low Voltage Power Circuit Breakers or ABB EntelliGuard G circuit breakers also provided with I-ZSI. Selectivity is limited by the short circuit rating of downstream device or upstream device.

**Table 9: Upstream WavePro ANSI circuit breakers**

Downstream Devices: Spectra with microEntelliGuard <sup>2</sup>	Upstream Devices													
	WPS-08	WPH-08	WPX-08	WPS-16	WPH-16	WPX-16	WPS-20	WPS-32	WPH-32	WPX-32	WPS-40	WPX-40	WPS-50	WPX-50
1200A	— <sup>1</sup>	— <sup>1</sup>	— <sup>1</sup>	30	42	65	65	65	85	100	85	100	85	100
800A	— <sup>1</sup>	— <sup>1</sup>	— <sup>1</sup>	30	42	65	65	65	85	100	85	100	85	100
600A	30	42	65	30	42	65	65	65	85	100	85	100	85	100

**Table 10: Upstream EntelliGuard G ANSI / UL1066 Circuit Breakers**

Downstream Devices: Spectra with microEntelliGuard <sup>2</sup>	Upstream Devices																							
	800A	800A	800A	800A	1600A	1600A	1600A	1600A	2000A	2000A	2000A	2000A	3200A	3200A	3200A	3200A	3200A	4000A	4000A	4000A	5000A	5000A	5000A	
	N-65kA	H-85kA	E-85kA	M-100kA	N-65kA	H-85kA	E-85kA	M-100kA	N-65kA	H-85kA	E-85kA	M-100kA	N-65kA	E-85kA	M-100kA	B-100kA	L-150kA	M-100kA	B-100kA	L-150kA	M-100kA	B-100kA	L-150kA	
1200A	— <sup>1</sup>	— <sup>1</sup>	— <sup>1</sup>	— <sup>1</sup>	65	65	85	85	65	65	85	85	65	85	85	100	100	85	100	100	85	100	100	
800A	— <sup>1</sup>	— <sup>1</sup>	— <sup>1</sup>	— <sup>1</sup>	65	65	85	85	65	65	85	85	65	85	85	100	100	85	100	100	85	100	100	
600A	65	65	85	85	65	65	85	85	65	65	85	85	65	85	85	100	100	85	100	100	85	100	100	

**Notes:**

1. Spectra circuit breakers may be instantaneously selective if the trip settings allow the Long-Time and Short-Time curves to be selective per examination of the applicable time current curves.
2. Spectra G & K circuit breakers are available in multiple short circuit ratings ranging from 35 to 100kA at 480V. Instantaneous selectivity is only possible up to short circuit rating of the lowest device in the selective pair.
3. Selectivity values are shown in kA.

**Table 11: Upstream EntelliGuard G UL489**

Downstream Devices: Spectra with microEntelliGuard <sup>2</sup>	Upstream Devices																			
	800A	800A	800A	1600A	1600A	1600A	2000A	2000A	2000A	3000A	3000A	3000A	3000A	4000A	4000A	5000A	5000A	6000A	6000A	
	N-65kA	H-85kA	M-100kA	N-65kA	H-85kA	M-100kA	N-65kA	H-85kA	M-100kA	N-65kA	H-85kA	M-100kA	L-150kA	M-100kA	L-150kA	M-100kA	L-150kA	M-100kA	L-150kA	
1200A	— <sup>1</sup>	— <sup>1</sup>	— <sup>1</sup>	42	50	100	42	50	65	42	50	65	85	65	85	65	85	65	85	
800A	— <sup>1</sup>	— <sup>1</sup>	— <sup>1</sup>	42	50	100	42	50	65	42	50	65	85	65	85	65	85	65	85	
600A	42	50	65	42	50	100	42	50	65	42	50	65	85	65	85	65	85	65	85	

**Notes:**

1. Spectra circuit breakers may be instantaneously selective if the trip settings allow the Long-Time and Short-Time curves to be selective per examination of the applicable time current curves, (i.e., if the load side Spectra Long-Time, Short-Time, and Instantaneous settings are sufficiently lower than that of the line side device).
2. Spectra G & K circuit breakers are available in multiple short circuit ratings ranging from 35 to 100kA at 480V. Instantaneous selectivity is only possible up to short circuit rating of the lowest device in the selective pair.
3. Long time curves, short time pickup and instantaneous pickup must be adjusted per TCC.
4. Selectivity values are shown in kA.

**Figures 6 & 7: Selectivity with respect to current over time**

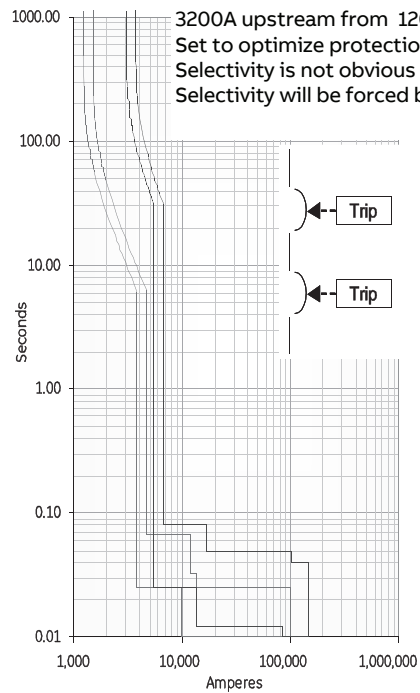

**Example: Upstream 3200A EntelliGuard G with Downstream 1200A Spectra K. When set for optimal protection, overlap in the INST regions indicate a lack of selectivity. Intelligent selectivity is forced by ArcWatch I-ZSI.**

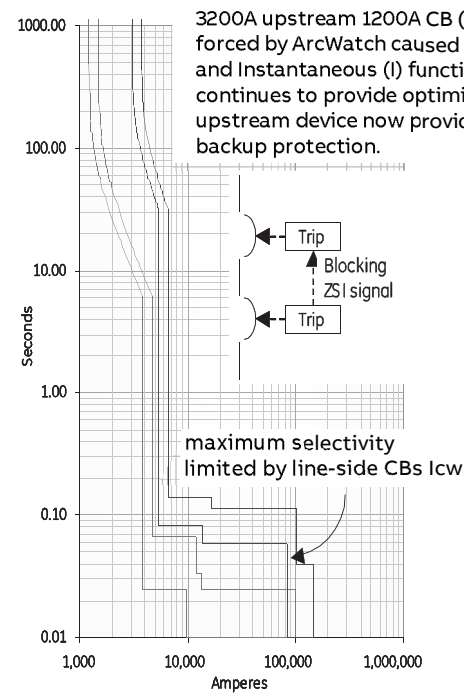

This page left intentionally blank

This page left intentionally blank

---

**ABB Inc.**  
305 Gregson Drive  
Cary, NC 27511

© Copyright 2020 ABB. All rights reserved  
Information provided is subject to change without notice. Please verify all details with ABB. All values are design or typical values when measured under laboratory conditions, and ABB makes no warranty or guarantee, express or implied, that such performance will be obtained under end-use conditions.  
GE is a registered trademark used under license from General Electric company.

**[electrification.us.abb.com](http://electrification.us.abb.com)**