

BI-Lok
**Series D Dual Ferrule
Instrument Tube Fittings**

GENERANT Fluid Connectors

BI-LOK to MALE NPT

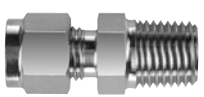

DCT
Male NPT Connector Page 8

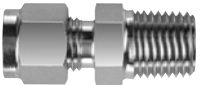

DCTZ
Thermocouple Connector Page 10

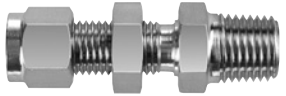

DSC
Bulkhead Male NPT Connector Page 19

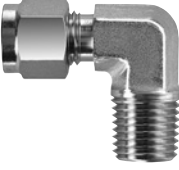

DLN
Male NPT Elbow Page 14

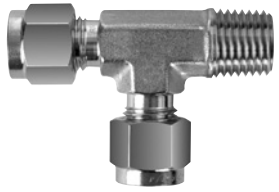

DTK
Male NPT Run Tee Page 24

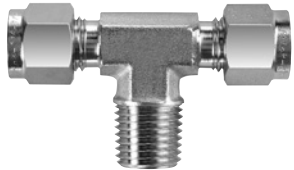

DTN
Male NPT Branch Tee Page 24



DHA
Tube Stub to Male NPT Adapter Page 11

BI-LOK UNION

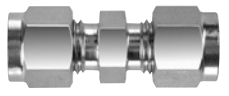

DUA
Union Page 26



DUR
Reducing Union Page 27



DSU
Bulkhead Union Page 21



DLA
Union Elbow Page 12

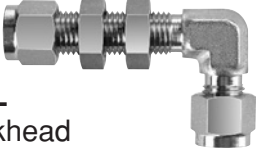

DSL
Bulkhead Union Elbow Page 20

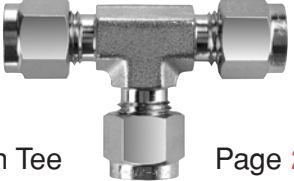

DTA
Union Tee Page 22



DTR
Reducing Union Tee Page 25

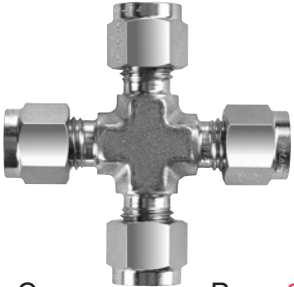

DXA
Union Cross Page 28

BI-LOK to FEMALE NPT

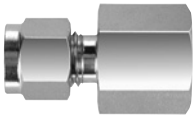

DSA
Female NPT Connector Page 18-19

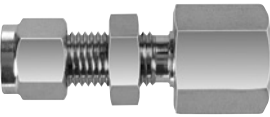

DSS
Bulkhead Female NPT Connector Page 21

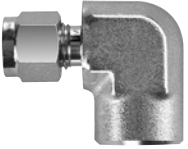

DLF
Female NPT Elbow Page 13

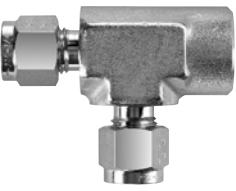

DTF
Female NPT Run Tee Page 22

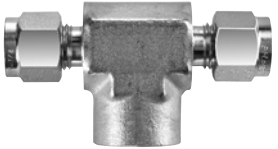

DTH
Female NPT Branch Tee Page 23

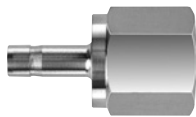

DHC
Tube Stub to Female NPT Adapter Page 12

BI-LOK to AN 37° FLARE



DUC
AN 37° Flare Union Page 26

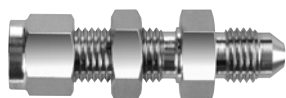

DUE
Bulkhead AN 37° Flare Union Page 27



DAN
AN 37° Flare Adapter Page 5

TUBE STUB



DRE
Reducer Page 17-18

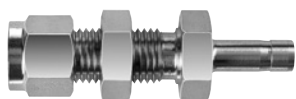

DSE
Bulkhead Adapter Page 20



DPC
Port Connector Page 17

BI-LOK to WELD

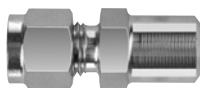

DCB
Male Pipe Weld Connector Page 6



DLB
Male Pipe Weld Elbow Page 13



DCW
Tube Socket Weld Union Page 9

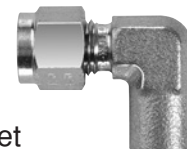

DLW
Tube Socket Weld Elbow Page 15

PLUG AND CAP



DBA
Plug Page 5



DCA
Cap Page 6

BI-LOK to SAE/MS STRAIGHT THREAD



DCU
SAE/MS Male Straight Thread Connector Page 9

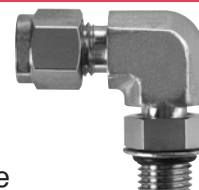

DLO
Positionable SAE/MS Male Straight Thread Elbow Page 15

BI-LOK to O-SEAL

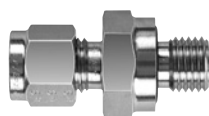

DCO
O-Seal Male Straight Thread Connector Page 7

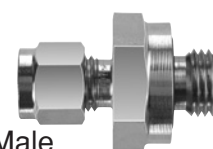

DCM
O-Seal Male NPT Connector Page 7

COMPONENTS



DOF
Front Ferrule Page 16



DOB
Back Ferrule Page 16



DNA
Nut Page 15



DOS
Ferrule Set Page 16



DTI
Tube Insert Page 23

CONSTRUCTION AND OPERATION

BI-Lok Series D Dual Ferrule Tube Fittings are composed of four precision machined component parts: 1) fitting body, 2) front ferrule, 3) back ferrule, 4) nut. BI-Lok Tube Fittings are shipped fully assembled and individually bagged. Once the tubing has been fully inserted into the fitting, a leak tight seal is achieved through the simple action of tightening the nut against the fitting body. The tightening of the nut provides the axial thrust required to engage the captively held ferrules against the outside diameter of the tubing. The staged swaging action of the ferrules, with minimal torque transfer to the tubing during make-up, provides the key to BI-Lok's high integrity sealing capability and exceptional service life.

MATERIALS OF CONSTRUCTION

Component		Fitting Material	
		Brass	316 Stainless Steel
Fitting Body	Forged	ASTM B124, CDA 377	ASTM A182
	Bar Stock	ASTM B16, CDA 360	ASTM A479
Front Ferrule Back Ferrule Nut			

Stainless Steel Fitting Bodies and Nuts are Heat /Lot code traceable. Stainless steel nuts are silver plated to prevent gauling and reduce make-up torque.

QUALITY CONTROL

BI-Lok Tube Fittings are designed, manufactured and inspected to the rigid quality requirements of our ISO certified production facility. All Stainless Steel Fittings are Heat/Lot code traceable. BI-Lok Tube Fittings have been tested and certified to a variety of Global International Industry standards and regulatory agencies.

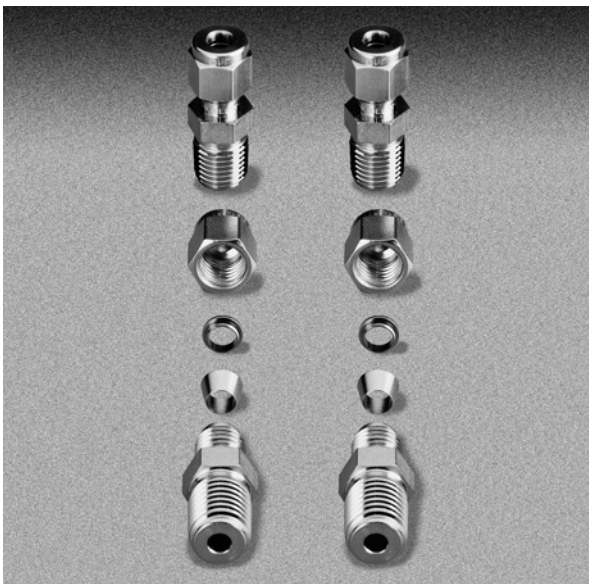

*Swagelok® is a registered trade mark of the Swagelok Company

INTERCHANGEABILITY AND GAGEABILITY

BI-Lok Series D Dual Ferrule Tube Fittings are manufactured to be completely component intermixable with the Swagelok® brand of tube fittings. Independent third party testing concluded that piece by piece intermixing of each manufacturer's component parts, in various combinations, yielded no performance degradation of the fitting connection. BI-Lok Dual Ferrule Tube Fittings are fully compatible for use with the Swagelok® brand Gap Inspection Gauges.

TUBING SELECTION AND PREPARATION

The selection of the proper tubing is essential to both the performance and safety of a tubing system. Careful consideration should be applied to the following variables; system pressure, media, flow, operating temperature and environmental conditions. Tube fittings should always be used with similar tube materials. i.e.; Stainless Steel fittings with Stainless Steel tubing and Brass fittings with copper tubing. In order to achieve proper fitting make-up, the tubing must be softer than the fitting material. For stainless steel tubing, we recommend fully annealed seamless or welded and drawn tubing of ASTM A269, A213 and A249. Tubing hardness should not exceed Rockwell B-90. For copper tubing, seamless or soft annealed ASTM B-75, or seamless soft annealed Type K or Type L water tubing ASTM B-88 is recommended. Care should be taken in tube handling to ensure that tubing is reasonably straight and is cut in a manner to create smooth square ends, free of burrs. Handling practices should consider that surface scratches on the tube OD may be a potential source of leaks.



PRESSURE RATINGS

The BI-Lok Dual Series D Ferrule Tube Fitting consists of four elements – nut, front ferrule, back ferrule and fitting body. However, the actual sealing function is accomplished with the addition of a fifth element, the tubing itself. Therefore, the pressure rating of the fitting assembly is a direct function of the tubing selected. Proper tube selection is critical and the ultimate responsibility of the system designer/user. The tables listed on page 2 provide the allowable pressure ratings of a variety of commonly used tube sizes and materials.

STAINLESS STEEL TUBING												
Tube OD	Tube Wall Thickness (Inches)											
	0.010	0.012	0.014	0.016	0.020	0.028	0.035	0.049	0.065	0.083	0.095	0.109
1/16"	5600	6800	8100	9400	12000							
1/8"						8500	10900					
3/16"						5400	7000	10200				
1/4"						4000	5100	7500	10200			
5/16"							4000	5800	8000			
3/8"							3300	4800	6500			
1/2"							2600	3700	5100	6700		
5/8"								2900	4000	5200		
3/4"								2400	3300	4200	4900	5800
7/8"								2000	2800	3600	4200	4800
1"									2400	3100	3600	4200

304 and 316 annealed seamless tubing per ASTM A-269 or equivalent working pressure are based on allowable stress of 20,000 psi between -20° F and 100° F (Reference: ANSI B31.3)

COPPER TUBING								
Tube OD	Tube Wall Thickness (Inches)							
	0.028	0.035	0.049	0.065	0.083	0.095	0.109	0.120
1/8"	2700	3600	5100					
3/16"	1800	2300	3400					
1/4"	1300	1600	2500	3500				
5/16"		1300	1900	2700				
3/8"		1000	1600	2200				
1/2"		800	1100	1600	2100			
5/8"			900	1200	1600	1900		
3/4"			700	1000	1300	1500	1800	
7/8"			600	800	1100	1300	1500	
1"			500	700	900	1100	1300	1500

Copper tubing per ASTM B-75 or equivalent. Working pressures are based on allowable stress of 6,000 psi between -70°F and 100° F (Reference: ANSI B31.3)

STRESS FACTORS				
Stress Factor used to calculate maximum allowable working pressures at elevated temperatures.				
NOTE: To find the maximum allowable working pressures for various tube materials at elevated temperatures, simply multiply the maximum allowable working pressure for the tube size and wall thickness found in these charts by the correct Stress Factor found in the table below:				
Temperature Stress Factor				
TEMP (°F)	304 Stainless Steel	316 Stainless Steel	Carbon Steel	Copper
200	1.00	1.00	.95	.80
400	.93	.96	.87	.50
600	.82	.85		
800	.76	.79		
1000	.69	.76		

CARBON STEEL TUBING								
Tube OD	Tube Wall Thickness, (Inches)							
	0.028	0.035	0.049	0.065	0.083	0.095	0.109	0.120
1/8"	8000	10200						
3/16"	5100	6600	9600					
1/4"	3700	4800	7000	9600				
5/16"		3700	5500	7500				
3/8"		3100	4500	6200				
1/2"		2300	3200	4500	5900			
5/8"		1800	2600	3500	4600	5300		
3/4"			2100	2900	3700	4300	5100	
7/8"			1800	2400	3200	3700	4300	
1"			1500	2100	2700	3200	3700	4100

Carbon steel hydraulic tubing per ASTM A-179 or equivalent. Working pressures are based on allowable stress of 15,700 psi between -70°F and 100° F (Reference: ANSI B31.3)

PIPE END PRESSURE RATINGS				
NPT Pipe Size	316 Stainless and Carbon Steel		Brass	
	Male	Female	Male	Female
1/8"	10000	6500	5000	3200
1/4"	8000	6600	4000	3300
3/8"	7800	5300	3900	2600
1/2"	7700	4900	3800	2400
3/4"	7300	4600	3600	2300
1"	5300	4400	2600	2200

Fittings with both Tube and NPT threaded pipe end connections have different pressure ratings. When specifying these type fittings, please refer to this chart for maximum allowable pressure ratings. A thread sealant is recommended when using NPT connections.

ASSEMBLY INSTRUCTIONS

Assembly Instructions

The following procedures refer to the proper assembly of the BI-Lok Series D Dual Ferrule Tube Fittings.

1. BI-Lok Tube Fittings are supplied fully assembled and individually bagged, allowing for clean efficient make-up. Should component assembly be required, please note that the order of assembly is the front ferrule into the cone of fitting body, back ferrule and fitting nut as noted in Fig. 1.

2. Insert the tubing into the fitting body until it bottoms out against the tube stop shoulder of the fitting. Please note that tubing should be cut squarely and free of burrs.

3. Hand tighten the nut as much as possible, bringing the fitting to what is called the "finger tight" position.

4. Secure the fitting body with a wrench and tighten the nut with another wrench an additional 3/4 of a turn for tube sizes 1/16" thru 3/16" or for sizes 1/4" and above 1-1/4 turns. (refer to Fig. 2a, 2b, and 2c).

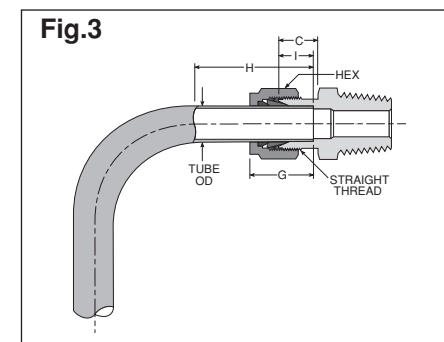
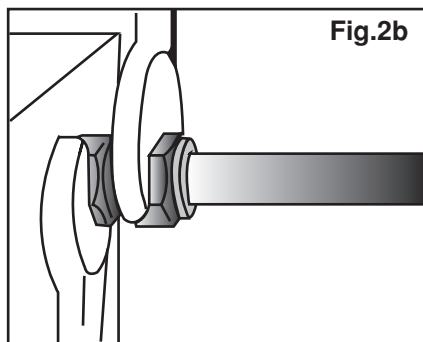
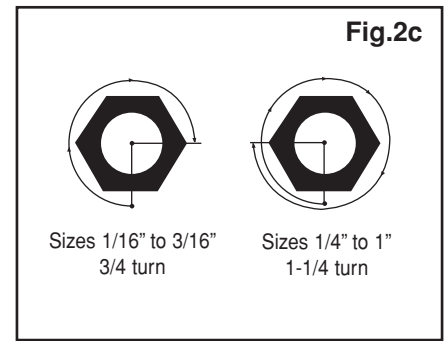
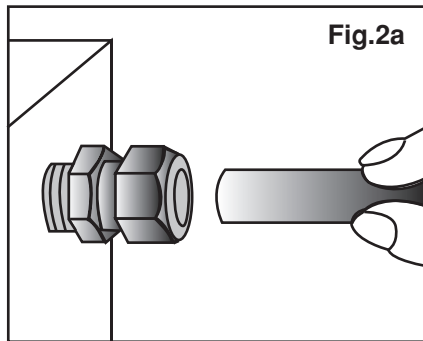
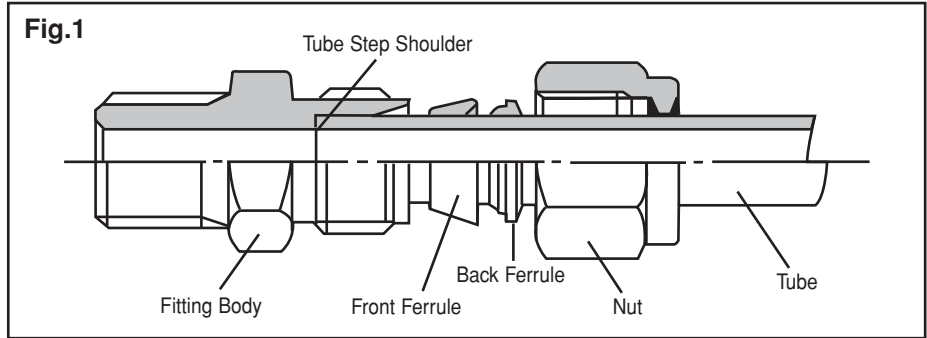

Reassembly Instructions

To reassemble a BI-Lok Series D Dual Ferrule Tube Fitting, simply insert the tube assembly (nut, front and back ferrule pre-swaged on the tube) into the fitting body and hand tighten the nut. Next, using a wrench, rotate the nut approximately 1/4 of a turn (back to the original make-up position) and then tighten the nut slightly.

Tube Measuring and Fitting

When measuring and bending tubing it is important to be aware of two critical measurements. The first being the tube insertion depth (reference dimension G) into the fitting assembly which must be considered in the determining the over all length of tube required. The other being the minimum length of straight tubing required for a proper tube bend (reference dimension H). Both measurements are dependant on tube OD; please use Fig. 3 for reference purposes.

Tube Size	A Tube OD	Straight Thread	Hex Tube Nut	C	G	H	I
1	1/16"	10-32	5/16"	0.27	0.34	1/2"	0.19
2	1/8"	5/16"-20	7/16"	0.34	0.50	23/32"	0.25
3	3/16"	3/8"-20	1/2"	0.37	0.54	3/4"	0.28
4	1/4"	7/16"-20	9/16"	0.40	0.60	13/16"	0.31
5	5/16"	1/2"-20	5/8"	0.44	0.64	7/8"	0.34
6	3/8"	9/16"-20	11/16"	0.47	0.66	15/16"	0.37
8	1/2"	3/4"-20	7/8"	0.47	0.90	13/16"	0.50
10	5/8"	7/8"-20	1"	0.47	0.96	1 1/4"	0.56
12	3/4"	1"-20	1 1/8"	0.47	0.96	1 1/4"	0.56
14	7/8"	1 1/8"-20	1 1/4"	0.47	1.02	1 5/16"	0.63
16	1"	1 5/16"-20	1 1/2"	0.56	1.23	1 1/2"	0.75

ORDERING INFORMATION

How To Order

BI-Lok tube fittings are ordered by part number as listed in this catalog. The part numbering system is designed so that you can easily identify the type, configuration, size and material of the fitting. Using the example below, specify the Fitting Type, Size Designator, Material and any additional Options desired.

DCT

Fitting Type

-

4-4

Size Designator

-

SS

Material

-

*

Option

N - Nylon Ferrules
 T - Teflon Ferrules
 X - Cleaned and packaged for oxygen service

SS - 316 stainless steel, ASTM A479
 B - Brass, ASTM B16

Type	Description	Page	End Connection 1	End Connection 2
DAN	AN 37° Flare Union	5	Tube OD	AN Flare
DBA	Plug	5		Tube OD
DCA	Cap	6		Tube OD
DCB	Male Pipe Weld Connector	6	Tube OD	Male Weld Pipe
DCM	O-Seal Male NPT Connector	7	Tube OD	Male NPT
DCO	O-Seal Male Straight Thread Connector	7	Tube OD	Straight Thread
DCT	Male NPT Connector	8	Tube OD	Male NPT
DCU	SAE/MS Male Straight Thread Connector	9	Tube OD	Straight Thread
DCW	Tube Socket Weld Union	9		Tube OD
DCTZ	Male NPT Connector	10	Tube OD	Male NPT
DHA	Tube Stub to Male NPT Adapter	11	Tube Stub	Male NPT
DHC	Tube Stub to Female NPT Adapter	12	Tube Stub	Female NPT
DLA	Union Elbow	12		Tube OD
DLB	Male Pipe Weld Elbow	13	Tube OD	Male Weld Pipe
DLF	Female NPT Elbow	13	Tube OD	Female NPT
DLN	Male NPT Elbow	14	Tube OD	Male NPT
DLO	Positionalbe SAE/MS Male Straight Thread Elbow	15	Tube OD	Straight Thread
DLW	Tube Socket Weld Elbow	15		Tube OD
DNA	Nut	15		Tube OD
DOB	Back Ferrule	16		Tube OD
DOF	Front Ferrule	16		Tube OD
DOS	Ferrule Set	16		Tube OD
DPC	Port Connector	17	Tube OD	Tube Stub
DRE	Reducer	17-18	Tube OD	Tube Stub
DSA	Female NPT Connector	18-19	Tube OD	Female NPT
DSC	Bulkhead Male NPT Connector	19	Tube OD	Male NPT
DSE	Bulkhead Reducer	20	Tube OD	Tube Stub
DSL	Bulkhead Union Elbow	20		Tube OD
DSS	Bulkhead Female NPT Connector	21	Tube OD	Female NPT
DSU	Bulkhead Union	21		Tube OD
DTA	Union Tee	22		Tube OD
DTF	Female NPT Run Tee	22	Tube OD	Female NPT
DTH	Female NPT Branch Tee	23	Tube OD	Female NPT
DTI	Tube Insert	23	Tube OD	Tube ID
DTK	Male NPT Run Tee	24	Tube OD	Male NPT
DTN	Male NPT Branch Tee	24	Tube OD	Male NPT
DTR	Reducing Union Tee	25	Tube OD	Tube OD*
DUA	Union	26		Tube OD
DUC	AN 37° Flare Union	26	Tube OD	AN Flare
DUE	Bulkhead AN 37° Flare Union	27	Tube OD	AN Flare
DUR	Reducing Union	27	Tube OD	Tube OD
DXA	Union Cross	28		Tube OD

Size Indicator	Tube OD or Threaded Connection
1	1/16"
2	1/8"
3	3/16"
4	1/4"
5	5/16"
6	3/8"
8	1/2"
10	5/8"
12	3/4"
14	7/8"
16	1"

*For DTR specify end connection, 1, 2 and 3, see page 25.

AN 37° FLARE ADAPTER



PART No.	A Tube OD	Hex Tube Nut	AN Tube Size	L	J	Hex Body
DAN-2-2-*	1/8"	7/16"	1/8"	0.77	0.54	3/8"
DAN-2-4-*	1/8"	7/16"	1/4"	0.80	0.62	9/16"
DAN-4-4-*	1/4"	9/16"	1/4"	0.88	0.62	9/16"
DAN-6-6*	3/8"	11/16"	3/8"	0.98	0.72	11/16"
DAN-8-8-*	1/2"	7/8"	1/2"	1.25	0.85	7/8"
DAN-16-16-*	1"	1 1/2"	1"	1.71	1.12	1 1/2"

* Add Suffix "SS" for 316 Stainless Steel or "B" for Brass.

PLUG



PART No.	A Tube OD	Hex Tube Nut	L
DBA-1-*	1/16"	5/16"	0.31
DBA-2-*	1/8"	7/16"	0.47
DBA-3-*	3/16"	1/2"	0.47
DBA-4-*	1/4"	9/16"	0.50
DBA-5-*	5/16"	5/8"	0.53
DBA-6-*	3/8"	11/16"	0.56
DBA-8-*	1/2"	7/8"	0.69
DBA-10-*	5/8"	1"	0.69
DBA-12-*	3/4"	1 1/8"	0.69
DBA-14-*	7/8"	1 1/4"	0.69
DBA-16-*	1"	1 1/2"	0.81

* Add Suffix "SS" for 316 Stainless Steel or "B" for Brass.

Dimensions are provided in inches and are for reference only, subject to change. Dimensions shown are with the nut in the finger-tight position.

CAP

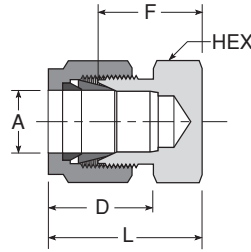
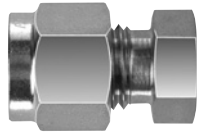

PART No.	A Tube OD	Hex Tube Nut	D	F	L OAL	Hex Body
DCA-1-*	1/16"	5/16"	0.44	0.44	0.59	5/16"
DCA-2-*	1/8"	7/16"	0.60	0.53	0.79	7/16"
DCA-3-*	3/16"	1/2"	0.63	0.58	0.84	7/16"
DCA-4-*	1/4"	9/16"	0.70	0.63	0.92	1/2"
DCA-5-*	5/16"	5/8"	0.73	0.67	0.96	9/16"
DCA-6-*	3/8"	11/16"	0.76	0.72	1.01	5/8"
DCA-8-*	1/2"	7/8"	0.86	0.75	1.14	13/16"
DCA-10-*	5/8"	1"	0.86	0.78	1.17	15/16"
DCA-12-*	3/4"	1 1/8"	0.86	0.84	1.23	1 1/16"
DCA-14-*	7/8"	1 1/4"	0.86	0.94	1.34	1 3/16"
DCA-16-*	1"	1 1/2"	1.04	1.03	1.51	1 3/8"

* Add Suffix "SS" for 316 Stainless Steel or "B" for Brass.

MALE PIPE WELD CONNECTOR

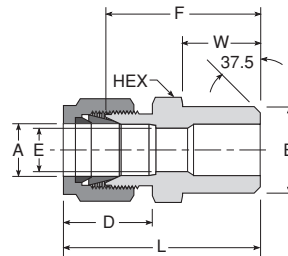
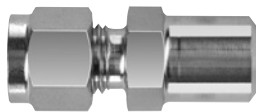

PART No.	A Tube OD	Hex Tube Nut	D	Pipe Size	B	W	E Min Orifice	F	L OAL	Hex Body
DCB-2-2-*	1/8"	7/16"	0.44	1/8"	0.405	0.38	0.09	0.92	1.18	7/16"
DCB-3-2-*	3/16"	1/2"	0.63	1/8"	0.405	0.38	0.12	0.97	1.23	7/16"
DCB-4-2-*	1/4"	9/16"	0.70	1/8"	0.405	0.38	0.19	1.00	1.30	1/2"
DCB-4-4-*	1/4"	9/16"	0.70	1/4"	0.540	0.56	0.19	1.20	1.49	9/16"
DCB-6-4-*	3/8"	11/16"	0.76	1/4"	0.540	0.56	0.28	1.28	1.57	5/8"
DCB-6-6-*	3/8"	11/16"	0.76	3/8"	0.675	0.56	0.28	1.28	1.57	11/16"
DCB-6-8-*	3/8"	11/16"	0.76	1/2"	0.840	0.75	0.28	1.51	1.81	7/8"
DCB-8-4-*	1/2"	7/8"	0.86	1/4"	0.540	0.56	0.41	1.31	1.72	13/16"
DCB-8-6-*	1/2"	7/8"	0.86	3/8"	0.675	0.56	0.41	1.31	1.71	13/16"
DCB-8-8-*	1/2"	7/8"	0.86	1/2"	0.840	0.75	0.41	1.51	1.92	7/8"
DCB-8-12-*	1/2"	7/8"	0.86	3/4"	1.050	0.75	0.41	1.59	2.00	1 1/16"
DCB-10-8-*	5/8"	1"	0.86	1/2"	0.840	0.75	0.50	1.53	1.93	15/16"
DCB-12-12-*	3/4"	1 1/8"	0.86	3/4"	1.050	0.75	0.62	1.59	1.99	1 1/16"
DCB-12-16-*	3/4"	1 1/8"	0.86	1"	1.315	0.94	0.62	1.87	2.28	1 3/8"
DCB-16-8-*	1"	1 1/2"	1.04	1/2"	0.840	0.75	0.88	1.77	2.27	1 3/8"
DCB-16-16-*	1"	1 1/2"	1.04	1"	1.315	0.94	0.88	1.97	2.45	1 3/8"

* Add Suffix "SS" for 316 Stainless Steel or "B" for Brass.

Dimensions are provided in inches and are for reference only, subject to change. Dimensions shown are with the nut in the finger-tight position.

O-SEAL MALE NPT CONNECTOR

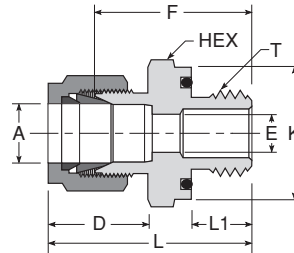
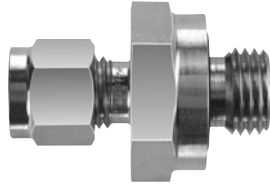

PART No.	A Tube OD	Hex Tube Nut	D	T NPT	L1	K	E Min Orifice	F	L OAL	Hex Body	O-Ring Size
DCM-2-2-*	1/8"	7/16"	0.60	1/8"	0.28	0.74	0.09	1.03	1.29	3/4"	- 111
DCM-4-2-*	1/4"	9/16"	0.70	1/8"	0.28	0.74	0.19	1.09	1.38	3/4"	- 111
DCM-4-4-*	1/4"	9/16"	0.70	1/4"	0.38	0.93	0.19	1.22	1.51	15/16"	- 113
DCM-6-2-*	3/8"	11/16"	0.76	1/8"	0.28	0.74	0.28	1.18	1.47	3/4"	- 111
DCM-6-4-*	3/8"	11/16"	0.76	1/4"	0.38	0.93	0.28	1.28	1.58	15/16"	- 113
DCM-8-8-*	1/2"	7/8"	0.86	1/2"	0.53	1.30	0.41	1.56	1.95	15/16"	- 212

* Add Suffix "SS" for 316 Stainless Steel or "B" for Brass.

O-SEAL MALE STRAIGHT THREAD CONNECTOR

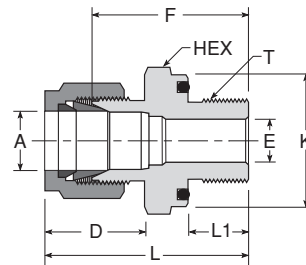
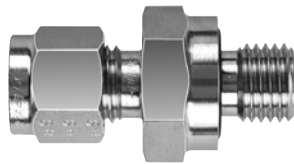

PART No.	A Tube OD	Hex Tube Nut	D	T Straight Thread	L1	K	E Min Orifice	F	L OAL	Hex Body	O-Ring Size
DCO-1-2-*	1/16"	5/16"	0.44	5/16"-24	0.34	0.55	0.05	0.90	1.05	9/16"	- 011
DCO-2-2-*	1/8"	7/16"	0.60	5/16"-24	0.34	0.55	0.09	1.02	1.29	9/16"	- 011
DCO-3-3-*	3/16"	1/2"	0.63	3/8"-24	0.38	0.62	0.12	1.10	1.36	5/8"	- 012
DCO-4-4-*	1/4"	9/16"	0.70	7/16"-20	0.41	0.74	0.19	1.23	1.51	3/4"	- 111
DCO-5-5-*	5/16"	5/8"	0.73	1/2"-20	0.44	0.86	0.25	1.32	1.60	7/8"	- 112
DCO-6-6-*	3/8"	11/16"	0.76	9/16"-18	0.47	0.93	0.28	1.38	1.67	15/16"	- 113
DCO-8-8-*	1/2"	7/8"	0.86	3/4"-16	0.47	1.11	0.41	1.41	1.81	1 1/8"	- 116
DCO-12-12-*	3/4"	1 1/8"	0.86	1 1/16"-12	0.56	1.49	0.62	1.65	2.06	1 1/2"	- 215

* Add Suffix "SS" for 316 Stainless Steel or "B" for Brass.

Note: To achieve proper leak-tight seal, a smooth flat surface perpendicular to the threads is necessary.

Dimensions are provided in inches and are for reference only, subject to change. Dimensions shown are with the nut in the finger-tight position.

MALE NPT CONNECTOR

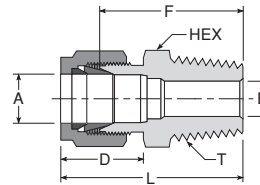
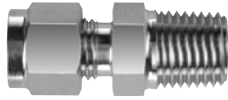

PART No.	A Tube OD	Hex Tube Nut	D	T NPT	E Min Orifice	F	L OAL	Hex Body
DCT-1-1-*	1/16"	5/16"	0.44	1/16"	0.05	0.79	0.94	5/16"
DCT-1-2-*	1/16"	5/16"	0.44	1/8"	0.05	0.85	1.00	7/16"
DCT-2-1-*	1/8"	7/16"	0.60	1/16"	0.09	0.91	1.17	7/16"
DCT-2-2-*	1/8"	7/16"	0.60	1/8"	0.09	0.91	1.17	7/16"
DCT-2-4-*	1/8"	7/16"	0.60	1/4"	0.09	1.12	1.39	9/16"
DCT-3-2-*	3/16"	1/2"	0.63	1/8"	0.12	0.94	1.21	7/16"
DCT-3-4-*	3/16"	1/2"	0.63	1/4"	0.12	1.16	1.43	9/16"
DCT-4-1-*	1/4"	9/16"	0.70	1/16"	0.19	1.00	1.30	1/2"
DCT-4-2-*	1/4"	9/16"	0.70	1/8"	0.19	1.00	1.30	1/2"
DCT-4-4-*	1/4"	9/16"	0.70	1/4"	0.19	1.19	1.49	9/16"
DCT-4-6-*	1/4"	9/16"	0.70	3/8"	0.19	1.22	1.52	11/16"
DCT-4-8-*	1/4"	9/16"	0.70	1/2"	0.19	1.44	1.76	7/8"
DCT-4-12-*	1/4"	9/16"	0.70	3/4"	0.19	1.47	1.77	11/16"
DCT-5-2-*	5/16"	5/8"	0.73	1/8"	0.25	1.05	1.35	9/16"
DCT-5-4-*	5/16"	5/8"	0.73	1/4"	0.25	1.23	1.53	9/16"
DCT-6-2-*	3/8"	11/16"	0.76	1/8"	0.28	1.09	1.39	5/8"
DCT-6-4-*	3/8"	11/16"	0.76	1/4"	0.28	1.28	1.57	5/8"
DCT-6-6-*	3/8"	11/16"	0.76	3/8"	0.28	1.28	1.57	11/16"
DCT-6-8-*	3/8"	11/16"	0.76	1/2"	0.28	1.50	1.80	7/8"
DCT-6-12-*	3/8"	11/16"	0.76	3/4"	0.28	1.54	1.83	11/16"
DCT-8-4-*	1/2"	7/8"	0.86	1/4"	0.28	1.31	1.72	13/16"
DCT-8-6-*	1/2"	7/8"	0.86	3/8"	0.41	1.31	1.72	13/16"
DCT-8-8-*	1/2"	7/8"	0.86	1/2"	0.41	1.50	1.91	7/8"
DCT-8-12-*	1/2"	7/8"	0.86	3/4"	0.41	1.54	1.94	11/16"
DCT-8-16-*	1/2"	7/8"	0.86	1"	0.41	1.87	2.28	13/8"
DCT-10-6-*	5/8"	1"	0.86	3/8"	0.41	1.34	1.74	15/16"
DCT-10-8-*	5/8"	1"	0.86	1/2"	0.50	1.54	1.94	15/16"
DCT-10-12-*	5/8"	1"	0.86	3/4"	0.50	1.53	1.94	11/16"
DCT-12-8-*	3/4"	11/8"	0.86	1/2"	0.50	1.59	2.00	11/16"
DCT-12-12-*	3/4"	11/8"	0.86	3/4"	0.62	1.59	2.00	11/16"
DCT-12-16-*	3/4"	11/8"	0.86	1"	0.62	1.87	2.28	13/8"
DCT-14-12-*	7/8"	11/4"	0.86	3/4"	0.72	1.59	1.99	113/16"
DCT-16-8-*	1"	11/2"	1.04	1/2"	0.50	1.77	2.27	13/8"
DCT-16-12-*	1"	11/2"	1.04	3/4"	0.72	1.77	2.27	13/8"
DCT-16-16-*	1"	11/2"	1.04	1"	0.88	1.97	2.46	13/8"

* Add Suffix "SS" for 316 Stainless Steel or "B" for Brass.

Dimensions are provided in inches and are for reference only, subject to change. Dimensions shown are with the nut in the finger-tight position.

SAE/MS MALE STRAIGHT THREAD CONNECTOR

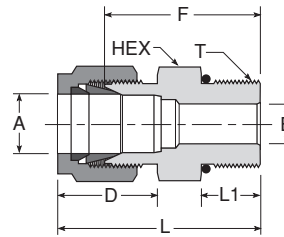
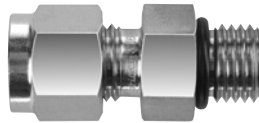

PART No.	A Tube OD	Hex Tube Nut	D	T Straight Thread	L1	E Min Orifice	F	L OAL	Hex Body	O-Ring Size
DCU-2-2-*	1/8"	7/16"	0.60	5/16"-24	0.30	0.09	0.92	1.19	7/16"	-902
DCU-4-4-*	1/4"	9/16"	0.70	7/16"-20	0.36	0.19	1.05	1.35	9/16"	-904
DCU-4-6-*	1/4"	9/16"	0.70	9/16"-18	0.39	0.19	1.11	1.41	11/16"	-906
DCU-4-8-*	1/4"	9/16"	0.70	3/4"-16	0.44	0.19	1.18	1.48	7/8"	-908
DCU-6-4-*	3/8"	11/16"	0.76	7/16"-20	0.36	0.28	1.11	1.41	5/8"	-904
DCU-6-6-*	3/8"	11/16"	0.76	9/16"-18	0.39	0.28	1.17	1.46	11/16"	-906
DCU-6-8-*	3/8"	11/16"	0.76	3/4"-16	0.44	0.28	1.25	1.55	7/8"	-908
DCU-6-10-*	3/8"	11/16"	0.76	7/8"-14	0.50	0.28	1.38	1.67	1"	-910
DCU-8-6-*	1/2"	7/8"	0.86	9/16"-18	0.39	0.41	1.14	1.55	13/16"	-906
DCU-8-8-*	1/2"	7/8"	0.86	3/4"-16	0.44	0.41	1.25	1.66	7/8"	-908
DCU-8-10-*	1/2"	7/8"	0.86	7/8"-14	0.50	0.41	1.38	1.79	1"	-910
DCU-8-12-*	1/2"	7/8"	0.86	1 1/16"-12	0.59	0.41	1.53	1.94	1 1/4"	-912
DCU-10-8-*	5/8"	1"	0.86	3/4"-16	0.44	0.50	1.25	1.66	15/16"	-908
DCU-10-10-*	5/8"	1"	0.86	7/8"-14	0.50	0.50	1.38	1.79	1"	-910
DCU-12-8-*	3/4"	1 1/8"	0.86	3/4"-16	0.44	0.62	1.29	1.70	1 1/16"	-908
DCU-12-12-*	3/4"	1 1/8"	0.86	1 1/16"-12	0.59	0.62	1.53	1.94	1 1/4"	-912
DCU-16-12-*	1"	1 1/2"	1.04	1 1/16"-12	0.59	0.89	1.63	2.13	1 3/8"	-912
DCU-16-16-*	1"	1 1/2"	1.04	1 5/16"-12	0.59	0.89	1.66	2.16	1 1/2"	-916

* Add Suffix "SS" for 316 Stainless Steel or "B" for Brass.

TUBE SOCKET WELD UNION

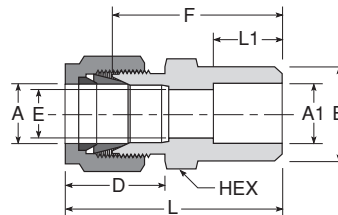
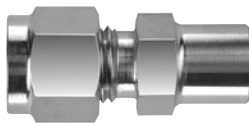

DCW	A Tube OD	Hex Tube Nut	D	A1 Tube OD	L1	B	E Min Orifice	F	L OAL	Hex Body
DCW-2-*	1/8"	5/16"	0.60	1/8"	0.25	0.31	0.09	0.88	1.14	7/16"
DCW-4-*	1/4"	9/16"	0.70	1/4"	0.31	0.44	0.19	1.03	1.32	1/2"
DCW-6-*	3/8"	11/16"	0.76	3/8"	0.38	0.62	0.28	1.19	1.48	5/8"
DCW-8-*	1/2"	7/8"	0.86	1/2"	0.50	0.75	0.41	1.22	1.62	13/16"
DCW-12-*	3/4"	1 1/8"	0.86	3/4"	0.56	1.05	0.62	1.31	1.71	1 1/16"
DCW-16-*	1"	1 1/2"	1.04	1"	0.75	1.31	0.89	1.59	2.07	1 3/8"

* Add Suffix "SS" for 316 Stainless Steel or "B" for Brass.

Dimensions are provided in inches and are for reference only, subject to change. Dimensions shown are with the nut in the finger-tight position.

THERMOCOUPLE CONNECTOR



PART No.	A Tube OD	Hex Tube Nut	D	T NPT	F	L OAL	Hex Body
DCTZ-1-1-*	1/16"	5/16"	0.44	1/16"	0.78	0.94	5/16"
DCTZ-1-2-*	1/16"	5/16"	0.44	1/8"	0.85	1.00	7/16"
DCTZ-1-4-*	1/16"	5/16"	0.44	1/4"	1.07	1.22	9/16"
DCTZ-2-1-*	1/8"	7/16"	0.60	1/16"	0.91	1.17	7/16"
DCTZ-2-2-*	1/8"	7/16"	0.60	1/8"	0.92	1.17	7/16"
DCTZ-2-4-*	1/8"	7/16"	0.60	1/4"	1.13	1.40	9/16"
DCTZ-2-6-*	1/8"	7/16"	0.60	3/8"	1.15	1.41	11/16"
DCTZ-2-8-*	1/8"	7/16"	0.60	1/2"	1.39	1.65	7/8"
DCTZ-3-2-*	3/16"	1/2"	0.63	1/8"	0.96	1.22	7/16"
DCTZ-3-4-*	3/16"	1/2"	0.63	1/4"	1.17	1.43	9/16"
DCTZ-4-2-*	1/4"	9/16"	0.70	1/8"	1.00	1.29	1/2"
DCTZ-4-4-*	1/4"	9/16"	0.70	1/4"	1.20	1.49	9/16"
DCTZ-4-6-*	1/4"	9/16"	0.70	3/8"	1.22	1.51	11/16"
DCTZ-4-8-*	1/4"	9/16"	0.70	1/2"	1.44	1.75	7/8"
DCTZ-5-4-*	5/16"	5/8"	0.73	1/4"	1.23	1.52	9/16"
DCTZ-5-8-*	5/16"	5/8"	0.73	1/2"	1.47	1.76	7/8"
DCTZ-6-4-*	3/8"	11/16"	0.76	1/4"	1.28	1.57	5/8"
DCTZ-6-6-*	3/8"	11/16"	0.76	3/8"	1.28	1.57	11/16"
DCTZ-6-8-*	3/8"	11/16"	0.76	1/2"	1.50	1.81	7/8"
DCTZ-8-6-*	1/2"	7/8"	0.86	3/8"	1.31	1.71	13/16"
DCTZ-8-8-*	1/2"	7/8"	0.86	1/2"	1.50	1.92	7/8"
DCTZ-8-12-*	1/2"	7/8"	0.86	3/4"	1.54	1.94	11/16"
DCTZ-10-8-*	5/8"	1"	0.86	1/2"	1.53	1.93	15/16"
DCTZ-10-12-*	5/8"	1"	0.86	3/4"	1.54	1.94	11/16"
DCTZ-12-12-*	3/4"	1 1/8"	0.86	3/4"	1.59	1.99	11/16"
DCTZ-14-16-*	7/8"	1 1/4"	0.86	1"	1.85	2.27	1 3/8"
DCTZ-16-16-*	1"	1 1/2"	1.04	1"	1.97	2.45	1 3/8"

* Add Suffix "SS" for 316 Stainless Steel or "B" for Brass.

Dimensions are provided in inches and are for reference only, subject to change. Dimensions shown are with the nut in the finger-tight position.

For use with thermocouples or other types of probes. Bored through fittings carry a reduced pressure rating. Please apply the following factor to the allowable working pressure of the tubing as stated on page 2.

Tube OD	Factor
Up to 1/2"	.75
Above 1/2" to 3/4"	.50
Above 3/4"	.25

TUBE STUB TO MALE NPT ADAPTER

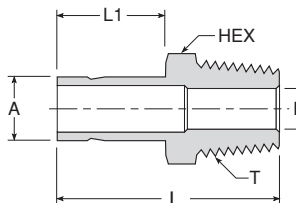
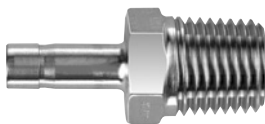

PART No.	A Tube OD	L1	T NPT	E Min Orifice	L OAL	Hex Body
DHA-2-2-*	1/8"	0.55	1/8"	0.08	1.12	7/16"
DHA-2-4-*	1/8"	0.55	1/4"	0.08	1.32	9/16"
DHA-3-2-*	3/16"	0.58	1/8"	0.12	1.15	7/16"
DHA-3-4-*	3/16"	0.58	1/4"	0.12	1.34	9/16"
DHA-4-2-*	1/4"	0.65	1/8"	0.19	1.22	7/16"
DHA-4-4-*	1/4"	0.65	1/4"	0.19	1.40	9/16"
DHA-4-6-*	1/4"	0.65	3/8"	0.19	1.44	11/16"
DHA-4-8-*	1/4"	0.65	1/2"	0.19	1.65	7/8"
DHA-5-2-*	5/16"	0.68	1/8"	0.25	1.25	7/16"
DHA-5-4-*	5/16"	0.68	1/4"	0.25	1.46	9/16"
DHA-6-2-*	3/8"	0.71	1/8"	0.28	1.31	7/16"
DHA-6-4-*	3/8"	0.71	1/4"	0.28	1.50	9/16"
DHA-6-6-*	3/8"	0.71	3/8"	0.28	1.50	11/16"
DHA-6-8-*	3/8"	0.71	1/2"	0.28	1.71	7/8"
DHA-8-4-*	1/2"	0.93	1/4"	0.39	1.71	9/16"
DHA-8-6-*	1/2"	0.93	3/8"	0.39	1.75	11/16"
DHA-8-8-*	1/2"	0.93	1/2"	0.39	1.93	7/8"
DHA-10-8-*	5/8"	0.99	1/2"	0.50	2.00	7/8"
DHA-12-8-*	3/4"	0.99	1/2"	0.59	2.00	7/8"
DHA-12-12-*	3/4"	0.99	3/4"	0.59	2.03	11/16"
DHA-12-16-*	3/4"	0.99	1"	0.59	2.28	13/8"
DHA-16-12-*	1"	1.28	3/4"	0.60	2.28	11/16"

* Add Suffix "SS" for 316 Stainless Steel or "B" for Brass.

Dimensions are provided in inches and are for reference only, subject to change. Dimensions shown are with the nut in the finger-tight position.

TUBE STUB TO FEMALE NPT ADAPTER



PART No.	A Tube OD	L1	T NPT	E Min Orifice	L OAL	Hex Body
DHC-2-2-*	1/8"	0.55	1/8"	0.08	1.22	9/16"
DHC-2-4-*	1/8"	0.55	1/4"	0.08	1.34	3/4"
DHC-3-2-*	3/16"	0.58	1/8"	0.13	1.26	9/16"
DHC-3-4-*	3/16"	0.58	1/4"	0.13	1.37	3/4"
DHC-4-2-*	1/4"	0.65	1/8"	0.19	1.32	9/16"
DHC-4-4-*	1/4"	0.65	1/4"	0.19	1.44	3/4"
DHC-4-8-*	1/4"	0.65	1/2"	0.19	1.78	1 1/16"
DHC-5-2-*	5/16"	0.68	1/8"	0.25	1.35	9/16"
DHC-5-4-*	5/16"	0.68	1/4"	0.25	1.46	3/4"
DHC-6-2-*	3/8"	0.71	1/8"	0.28	1.39	9/16"
DHC-6-4-*	3/8"	0.71	1/4"	0.28	1.50	3/4"
DHC-6-6-*	3/8"	0.71	3/8"	0.28	1.61	7/8"
DHC-6-8-*	3/8"	0.71	1/2"	0.28	1.83	1 1/16"
DHC-8-4-*	1/2"	0.93	1/4"	0.39	1.71	3/4"
DHC-8-6-*	1/2"	0.93	3/8"	0.39	1.85	7/8"
DHC-8-8-*	1/2"	0.93	1/2"	0.39	2.07	1 1/16"
DHC-10-6-*	5/8"	0.99	3/8"	0.50	1.90	7/8"
DHC-12-8-*	3/4"	0.99	1/2"	0.59	2.13	1 1/16"
DHC-12-12-*	3/4"	0.99	3/4"	0.59	2.18	1 1/4"

* Add Suffix "SS" for 316 Stainless Steel or "B" for Brass.

UNION ELBOW



PART No.	A Tube OD	Hex Tube Nut	D	E Min Orifice	C	C1	Wrench Flat
DLA-1-*	1/16"	5/16"	0.44	0.05	0.71	0.55	3/8"
DLA-2-*	1/8"	7/16"	0.60	0.09	0.88	0.62	3/8"
DLA-3-*	3/16"	1/2"	0.63	0.12	1.00	0.74	1/2"
DLA-4-*	1/4"	9/16"	0.70	0.19	1.06	0.77	1/2"
DLA-5-*	5/16"	5/8"	0.73	0.25	1.13	0.84	5/8"
DLA-6-*	3/8"	11/16"	0.76	0.28	1.20	0.91	5/8"
DLA-8-*	1/2"	7/8"	0.86	0.41	1.40	0.99	13/16"
DLA-10-*	5/8"	1"	0.86	0.50	1.48	1.07	15/16"
DLA-12-*	3/4"	1 1/8"	0.86	0.62	1.53	1.12	1 1/16"
DLA-14-*	7/8"	1 1/4"	0.86	0.72	1.69	1.29	1 1/4"
DLA-16-*	1"	1 1/2"	1.04	0.88	1.81	1.30	1 5/16"

* Add Suffix "SS" for 316 Stainless Steel or "B" for Brass.

Dimensions are provided in inches and are for reference only, subject to change. Dimensions shown are with the nut in the finger-tight position.

DLB

MALE PIPE WELD ELBOW

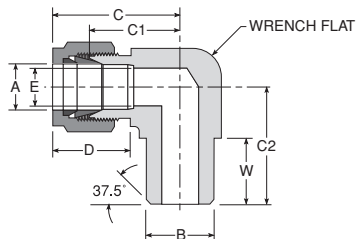

PART No.	A Tube OD	Hex Tube Nut	D	Pipe Size	B	W	E Min Orifice	C	C1	C2	Wrench Flat
DLB-4-2-*	1/4"	9/16"	0.70	1/8"	0.405	0.38	0.19	1.06	0.78	0.74	1/2"
DLB-4-4-*	1/4"	9/16"	0.70	1/4"	0.540	0.56	0.19	1.06	0.78	0.93	1/2"
DLB-6-4-*	3/8"	11/16"	0.76	1/4"	0.540	0.56	0.19	1.06	0.78	1.00	5/8"
DLB-6-6-*	3/8"	11/16"	0.76	3/8"	0.675	0.56	0.28	1.24	0.94	1.12	11/16"
DLB-8-8-*	1/2"	7/8"	0.86	1/2"	0.840	0.75	0.41	1.43	1.03	1.30	15/16"
DLB-16-16*	1"	1 1/2"	1.04	1"	1.315	1.05	0.89	1.81	1.31	1.84	15/16"

* Add Suffix "SS" for 316 Stainless Steel or "B" for Brass.

DLF

FEMALE NPT ELBOW

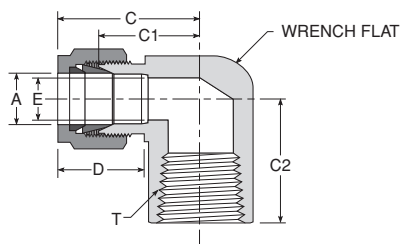
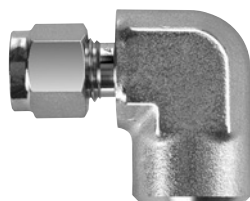

PART No.	A Tube OD	Hex Tube Nut	D	T NPT	E Min Orifice	C	C1	C2	Wrench Flat
DLF-2-2-*	1/8"	7/16"	0.60	1/8"	0.09	0.96	0.69	0.75	5/8"
DLF-2-4-*	1/8"	7/16"	0.60	1/4"	0.09	1.08	0.81	0.89	13/16"
DLF-4-2-*	1/4"	9/16"	0.70	1/8"	0.19	1.05	0.75	0.75	5/8"
DLF-4-4-*	1/4"	9/16"	0.70	1/4"	0.19	1.17	0.89	0.89	13/16"
DLF-4-6-*	1/4"	9/16"	0.70	3/8"	0.19	1.26	0.97	0.89	15/16"
DLF-4-8-*	1/4"	9/16"	0.70	1/2"	0.19	1.40	1.11	1.12	1 1/16"
DLF-5-2-*	5/16"	5/8"	0.73	1/8"	0.25	1.18	0.89	0.75	5/8"
DLF-5-4-*	5/16"	5/8"	0.73	1/4"	0.25	1.20	0.91	0.89	13/16"
DLF-6-2-*	3/8"	11/16"	0.76	1/8"	0.28	1.20	0.91	0.75	5/8"
DLF-6-4-*	3/8"	11/16"	0.76	1/4"	0.28	1.23	0.94	0.89	13/16"
DLF-6-6-*	3/8"	11/16"	0.76	3/8"	0.28	1.32	1.03	0.89	15/16"
DLF-6-8-*	3/8"	11/16"	0.76	1/2"	0.28	1.42	1.11	1.12	1 1/16"
DLF-8-4-*	1/2"	7/8"	0.86	1/4"	0.41	1.40	0.98	0.89	13/16"
DLF-8-6-*	1/2"	7/8"	0.86	3/8"	0.41	1.43	1.03	0.89	15/16"
DLF-8-8-*	1/2"	7/8"	0.86	1/2"	0.41	1.53	1.11	1.12	1 1/16"
DLF-8-12-*	1/2"	7/8"	0.86	3/4"	0.41	1.67	1.25	1.25	15/16"
DLF-10-6-*	5/8"	1"	0.86	3/8"	0.50	1.47	1.06	0.89	15/16"
DLF-10-8-*	5/8"	1"	0.86	1/2"	0.50	1.53	1.11	1.12	1 1/16"
DLF-12-8-*	3/4"	1 1/8"	0.86	1/2"	0.62	1.52	1.11	1.12	1 1/16"
DLF-12-12-*	3/4"	1 1/8"	0.86	3/4"	0.62	1.66	1.25	1.25	15/16"
DLF-14-12-*	7/8"	1 1/4"	0.86	3/4"	0.72	1.68	1.28	1.25	15/16"
DLF-16-12-*	1"	1 1/2"	1.04	3/4"	0.88	1.81	1.31	1.25	15/16"
DLF-16-16-*	1"	1 1/2"	1.04	1"	0.88	2.07	1.67	1.50	13/4"

* Add Suffix "SS" for 316 Stainless Steel or "B" for Brass.

Dimensions are provided in inches and are for reference only, subject to change. Dimensions shown are with the nut in the finger-tight position.

MALE NPT ELBOW

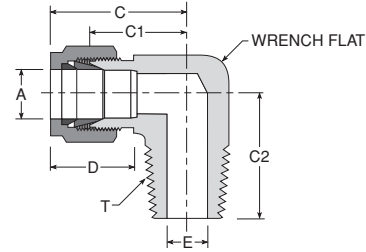
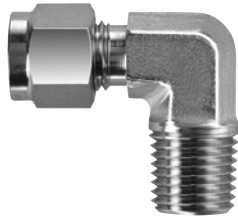

PART No.	A Tube OD	Hex Tube Nut	D	T NPT	E Min Orifice	C	C1	C2	Wrench Flat
DLN-1-1-*	1/16"	5/16"	0.44	1/16"	0.05	0.72	0.56	0.73	7/16"
DLN-1-2-*	1/16"	5/16"	0.44	1/8"	0.05	0.72	0.56	0.73	7/16"
DLN-2-1-*	1/8"	7/16"	0.60	1/16"	0.09	0.93	0.67	0.73	7/16"
DLN-2-2-*	1/8"	7/16"	0.60	1/8"	0.09	0.93	0.67	0.73	7/16"
DLN-2-4-*	1/8"	7/16"	0.60	1/4"	0.09	0.97	0.71	0.93	1/2"
DLN-3-2-*	3/16"	1/2"	0.63	1/8"	0.12	1.00	0.74	0.74	1/2"
DLN-3-4-*	3/16"	1/2"	0.63	1/4"	0.12	1.00	0.74	0.83	1/2"
DLN-4-1-*	1/4"	9/16"	0.70	1/16"	0.19	1.00	0.78	0.74	1/2"
DLN-4-2-*	1/4"	9/16"	0.70	1/8"	0.19	1.06	0.78	0.74	1/2"
DLN-4-4-*	1/4"	9/16"	0.70	1/4"	0.19	1.06	0.78	0.92	1/2"
DLN-4-6-*	1/4"	9/16"	0.70	3/8"	0.19	1.17	0.88	1.12	11/16"
DLN-4-8-*	1/4"	9/16"	0.70	1/2"	0.19	1.25	0.96	1.30	13/16"
DLN-5-2-*	5/16"	5/8"	0.73	1/8"	0.25	1.18	0.88	0.81	5/8"
DLN-5-4-*	5/16"	5/8"	0.73	1/4"	0.25	1.18	0.88	1.00	5/8"
DLN-5-6-*	5/16"	5/8"	0.73	3/8"	0.25	1.24	0.94	1.12	11/16"
DLN-6-2-*	3/8"	11/16"	0.76	1/8"	0.28	1.20	0.91	0.82	5/8"
DLN-6-4-*	3/8"	11/16"	0.76	1/4"	0.28	1.20	0.91	1.00	5/8"
DLN-6-6-*	3/8"	11/16"	0.76	3/8"	0.28	1.23	0.94	1.12	11/16"
DLN-6-8-*	3/8"	11/16"	0.76	1/2"	0.28	1.31	1.02	1.26	13/16"
DLN-6-12-*	3/8"	11/16"	0.76	3/4"	0.28	1.41	1.11	1.40	11/16"
DLN-8-4-*	1/2"	7/8"	0.86	1/4"	0.41	1.39	0.98	1.08	13/16"
DLN-8-6-*	1/2"	7/8"	0.86	3/8"	0.41	1.39	0.98	1.08	13/16"
DLN-8-8-*	1/2"	7/8"	0.86	1/2"	0.41	1.44	1.03	1.32	13/16"
DLN-8-12-*	1/2"	7/8"	0.86	3/4"	0.41	1.52	1.11	1.40	11/16"
DLN-10-6-*	5/8"	1"	0.86	3/8"	0.50	1.47	1.06	1.16	15/16"
DLN-10-8-*	5/8"	1"	0.86	1/2"	0.50	1.47	1.06	1.34	15/16"
DLN-10-12-*	5/8"	1"	0.86	3/4"	0.50	1.52	1.11	1.40	11/16"
DLN-12-8-*	3/4"	1 1/8"	0.86	1/2"	0.62	1.52	1.11	1.39	11/16"
DLN-12-12-*	3/4"	1 1/8"	0.86	3/4"	0.62	1.52	1.11	1.39	11/16"
DLN-14-12-*	7/8"	1 1/4"	0.86	3/4"	0.72	1.68	1.28	1.65	11/4"
DLN-16-12-*	1"	1 1/2"	1.04	3/4"	0.88	1.81	1.31	1.65	15/16"
DLN-16-16-*	1"	1 1/2"	1.04	1"	0.88	1.81	1.31	1.84	15/16"

* Add Suffix "SS" for 316 Stainless Steel or "B" for Brass.

Dimensions are provided in inches and are for reference only, subject to change. Dimensions shown are with the nut in the finger-tight position.

DLO

POSITIONABLE SAE/MS MALE STRAIGHT THREAD ELBOW

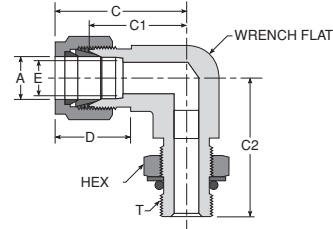

PART No.	A Tube OD	Hex Tube Nut	D	T Straight Thread	E Min Orifice	C	C1	C2	Hex Lock Nut	Wrench Flat	O-Ring Size
DLO-4-4-*	1/4"	9/16"	0.70	7/16"-20	0.19	1.12	0.83	1.12	9/16"	5/8"	-904
DLO-4-6-*	1/4"	9/16"	0.70	9/16"-18	0.19	1.20	0.91	1.27	11/16"	5/8"	-906
DLO-5-5-*	5/16"	5/8"	0.73	1/2"-20	0.23	1.19	0.90	1.16	5/8"	5/8"	-905
DLO-6-6-*	3/8"	11/16"	0.76	9/16"-18	0.28	1.26	0.97	1.27	11/16"	5/8"	-906
DLO-6-8-*	3/8"	11/16"	0.76	3/4"-16	0.28	1.37	1.08	1.49	7/8"	13/16"	-908
DLO-8-8-*	1/2"	7/8"	0.86	3/4"-16	0.41	1.48	1.08	1.49	7/8"	13/16"	-908

* Add Suffix "SS" for 316 Stainless Steel or "B" for Brass.

DLW

TUBE SOCKET WELD ELBOW

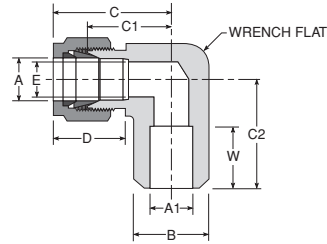
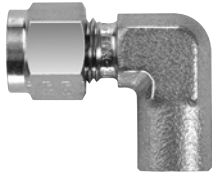

PART No.	A Tube OD	Hex Tube Nut	D	A1 Tube OD	W	B	E Min Orifice	C	C1	C2	Wrench Flat
DLW-2-*	1/8"	5/16"	0.60	1/8"	0.25	0.44	0.09	0.89	0.62	0.89	3/8"
DLW-4-*	1/4"	9/16"	0.70	1/4"	0.31	0.57	0.19	1.06	0.77	1.07	1/2"
DLW-6-*	3/8"	11/16"	0.76	3/8"	0.38	0.70	0.28	1.20	0.91	1.20	5/8"
DLW-8-*	1/2"	7/8"	0.86	1/2"	0.50	0.84	0.41	1.40	0.98	1.39	13/16"
DLW-16-*	1"	1 1/2"	1.04	1"	0.75	1.40	0.88	1.81	1.31	1.81	1 5/16"

* Add Suffix "SS" for 316 Stainless Steel or "B" for Brass.

DNA

NUT

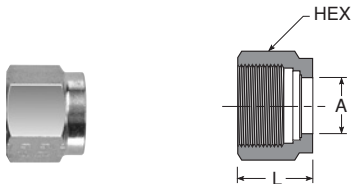

PART No.	A Tube OD	Hex Tube Nut	L OAL
DNA-1-*	1/16"	5/16"	0.31
DNA-2-*	1/8"	7/16"	0.47
DNA-3-*	3/16"	1/2"	0.47
DNA-4-*	1/4"	9/16"	0.50
DNA-5-*	5/16"	5/8"	0.53
DNA-6-*	3/8"	11/16"	0.56
DNA-8-*	1/2"	7/8"	0.69
DNA-10-*	5/8"	1"	0.69
DNA-12-*	3/4"	1 1/8"	0.69
DNA-14-*	7/8"	1 1/4"	0.69
DNA-16-*	1"	1 1/2"	0.81

* Add Suffix "SS" for 316 Stainless Steel or "B" for Brass.

Dimensions are provided in inches and are for reference only, subject to change. Dimensions shown are with the nut in the finger-tight position.

BACK FERRULE



PART No.	A Tube OD
DOB-1-*	1/16"
DOB-2-*	1/8"
DOB-3-*	3/16"
DOB-4-*	1/4"
DOB-5-*	5/16"
DOB-6-*	3/8"
DOB-8-*	1/2"
DOB-10-*	5/8"
DOB-12-*	3/4"
DOB-14-*	7/8"
DOB-16-*	1"

* Add Suffix "SS" for 316 Stainless Steel or "B" for Brass.

FRONT FERRULE

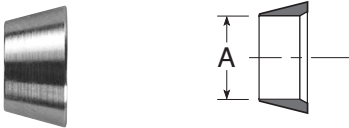

PART No.	A Tube OD
DOF-1-*	1/16"
DOF-2-*	1/8"
DOF-3-*	3/16"
DOF-4-*	1/4"
DOF-5-*	5/16"
DOF-6-*	3/8"
DOF-8-*	1/2"
DOF-10-*	5/8"
DOF-12-*	3/4"
DOF-14-*	7/8"
DOF-16-*	1"

* Add Suffix "SS" for 316 Stainless Steel or "B" for Brass.

FERRULE SET

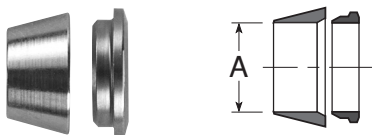

PART No.	A Tube OD
DOS-1-*	1/16"
DOS-2-*	1/8"
DOS-3-*	3/16"
DOS-4-*	1/4"
DOS-5-*	5/16"
DOS-6-*	3/8"
DOS-8-*	1/2"
DOS-10-*	5/8"
DOS-12-*	3/4"
DOS-14-*	7/8"
DOS-16-*	1"

* Add Suffix "SS" for 316 Stainless Steel or "B" for Brass.

DPC

PORT CONNECTOR

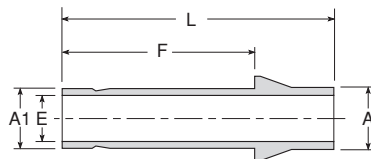

Note: SPECIAL INSTALLATION INSTRUCTIONS FOR MACHINED FERRULE END OF DPC.

From the finger-tight position, tighten nut 1/4 turn only. Subsequent connections are made by tightening slightly with a wrench after snugging nut by hand.

PART No.	A Tube OD	E Min Orifice	A1 Tube OD	F	L OAL
DPC-2-1-*	1/8"	0.03	1/16"	0.39	0.83
DPC-2-*	1/8"	0.09	1/8"	0.62	0.97
DPC-4-1-*	1/4"	0.03	1/16"	0.42	0.88
DPC-4-2-*	1/4"	0.09	1/8"	0.62	1.13
DPC-4-*	1/4"	0.19	1/4"	0.74	1.09
DPC-6-4-*	3/8"	0.19	1/4"	0.74	1.24
DPC-8-6-*	1/2"	0.28	3/8"	0.80	1.58
DPC-8-*	1/2"	0.39	1/2"	1.02	1.67
DPC-12-*	3/4"	0.59	3/4"	1.09	1.80
DPC-16-*	1"	0.80	1"	1.42	2.28

* Add Suffix "SS" for 316 Stainless Steel or "B" for Brass.

DRE

REDUCER

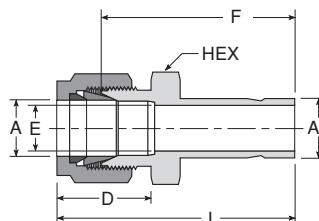
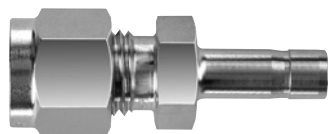

PART No.	A Tube OD	Hex Tube Nut	D	A1 Tube OD	E Min Orifice	F	L OAL	Hex Body
DRE-1-2-*	1/16"	5/16"	0.44	1/8"	0.05	1.00	1.15	5/16"
DRE-2-2-*	1/8"	7/16"	0.60	1/8"	0.08	1.06	1.32	7/16"
DRE-2-3-*	1/8"	7/16"	0.60	3/16"	0.09	1.09	1.36	7/16"
DRE-2-4-*	1/8"	7/16"	0.60	1/4"	0.09	1.16	1.42	7/16"
DRE-2-6-*	1/8"	7/16"	0.60	3/8"	0.09	1.22	1.48	7/16"
DRE-2-8-*	1/8"	7/16"	0.60	1/2"	0.09	1.48	1.74	9/16"
DRE-3-4-*	3/16"	1/2"	0.63	1/4"	0.08	1.20	1.46	7/16"
DRE-3-8-*	3/16"	1/2"	0.63	1/2"	0.12	1.50	1.84	9/16"
DRE-4-2-*	1/4"	9/16"	0.70	1/8"	0.08	1.16	1.45	1/2"
DRE-4-3-*	1/4"	9/16"	0.70	3/16"	0.12	1.19	1.48	1/2"
DRE-4-4-*	1/4"	9/16"	0.70	1/4"	0.19	1.25	1.54	1/2"
DRE-4-5-*	1/4"	9/16"	0.70	5/16"	0.19	1.28	1.57	1/2"
DRE-4-6-*	1/4"	9/16"	0.70	3/8"	0.19	1.31	1.60	1/2"
DRE-4-8-*	1/4"	9/16"	0.70	1/2"	0.19	1.54	1.82	9/16"
DRE-4-10-*	1/4"	9/16"	0.70	5/8"	0.19	1.53	1.89	11/16"
DRE-4-12-*	1/4"	9/16"	0.70	3/4"	0.19	1.69	1.89	7/8"
DRE-5-6-*	5/16"	5/8"	0.73	3/8"	0.25	1.36	1.65	9/16"
DRE-5-8-*	5/16"	5/8"	0.73	1/2"	0.25	1.58	1.87	9/16"

* Add Suffix "SS" for 316 Stainless Steel or "B" for Brass.

(CONTINUED ON NEXT PAGE)

Dimensions are provided in inches and are for reference only, subject to change. Dimensions shown are with the nut in the finger-tight position.

REDUCER CONTINUED

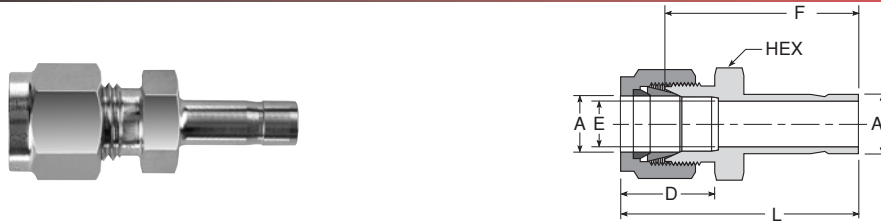

PART No.	A Tube OD	Hex Tube Nut	D	A1 Tube OD	E Min Orifice	F	L OAL	Hex Body
DRE-6-2-*	3/8"	11/16"	0.76	1/8"	0.08	1.24	1.54	5/8"
DRE-6-4-*	3/8"	11/16"	0.76	1/4"	0.19	1.27	1.57	5/8"
DRE-6-5-*	3/8"	11/16"	0.76	5/16"	0.19	1.34	1.63	5/8"
DRE-6-6-*	3/8"	11/16"	0.76	3/8"	0.28	1.41	1.70	5/8"
DRE-6-8-*	3/8"	11/16"	0.76	1/2"	0.28	1.62	1.91	5/8"
DRE-6-10-*	3/8"	11/16"	0.76	5/8"	0.28	1.69	1.98	11/16"
DRE-6-12-*	3/8"	11/16"	0.76	3/4"	0.28	1.69	1.98	13/16"
DRE-8-4-*	1/2"	7/8"	0.86	1/4"	0.19	1.39	1.79	13/16"
DRE-8-6-*	1/2"	7/8"	0.86	3/8"	0.28	1.45	1.85	13/16"
DRE-8-8-*	1/2"	7/8"	0.86	1/2"	0.39	1.66	2.07	13/16"
DRE-8-10-*	1/2"	7/8"	0.86	5/8"	0.41	1.72	2.12	13/16"
DRE-8-12-*	1/2"	7/8"	0.86	3/4"	0.41	1.72	2.12	13/16"
DRE-8-16-*	1/2"	7/8"	0.86	1"	0.41	1.97	2.37	1 1/16"
DRE-10-12-*	5/8"	1"	0.86	3/4"	0.50	1.75	2.15	15/16"
DRE-10-14-*	5/8"	1"	0.86	7/8"	0.50	1.81	2.21	15/16"
DRE-10-16-*	5/8"	1"	0.86	1"	0.50	2.02	2.42	1 1/16"
DRE-12-6-*	3/4"	1 1/8"	0.86	3/8"	0.62	1.55	1.96	1 1/16"
DRE-12-8-*	3/4"	1 1/8"	0.86	1/2"	0.39	1.79	2.19	1 1/16"
DRE-12-14-*	3/4"	1 1/8"	0.86	7/8"	0.62	1.85	2.26	1 1/16"
DRE-12-16-*	3/4"	1 1/8"	0.86	1"	0.62	2.07	2.46	1 1/16"
DRE-14-6-*	7/8"	1 1/4"	0.86	3/8"	0.72	1.63	2.04	1 3/16"
DRE-14-12-*	7/8"	1 1/4"	0.86	3/4"	0.72	1.90	2.30	1 3/16"
DRE-16-8-*	1"	1 1/2"	1.04	1/2"	0.88	2.03	2.52	1 3/8"
DRE-16-14-*	1"	1 1/2"	1.04	7/8"	0.88	2.09	2.59	1 3/8"

* Add Suffix "SS" for 316 Stainless Steel or "B" for Brass.

FEMALE NPT CONNECTOR

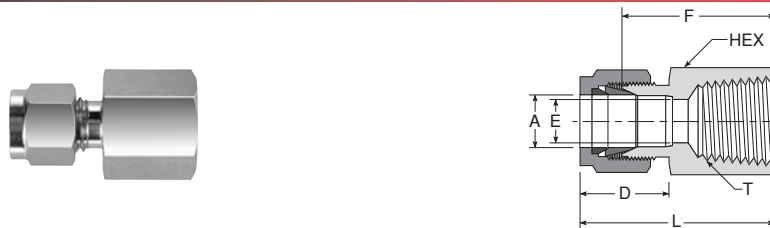

PART No.	A Tube OD	Hex Tube Nut	D	T NPT	E Min Orifice	F	L OAL	Hex Body
DSA-2-2-*	1/8"	7/16"	0.60	1/8"	0.09	0.80	1.14	9/16"
DSA-2-4-*	1/8"	7/16"	0.60	1/4"	0.09	1.06	1.32	3/4"
DSA-2-8-*	1/8"	7/16"	0.60	1/2"	0.09	1.34	1.80	1 1/16"
DSA-3-2-*	3/16"	1/2"	0.63	1/8"	0.12	0.91	1.17	9/16"
DSA-4-1-*	1/4"	9/16"	0.70	1/16"	0.19	0.94	1.23	1/2"
DSA-4-2-*	1/4"	9/16"	0.70	1/8"	0.19	0.94	1.23	9/16"
DSA-4-4-*	1/4"	9/16"	0.70	1/4"	0.19	1.12	1.41	3/4"
DSA-4-6-*	1/4"	9/16"	0.70	3/8"	0.19	1.19	1.48	7/8"
DSA-4-8-*	1/4"	9/16"	0.70	1/2"	0.19	1.40	1.70	1 1/16"

* Add Suffix "SS" for 316 Stainless Steel or "B" for Brass.

(CONTINUED ON NEXT PAGE)

Dimensions are provided in inches and are for reference only, subject to change. Dimensions shown are with the nut in the finger-tight position.

FEMALE NPT CONNECTOR CONTINUED

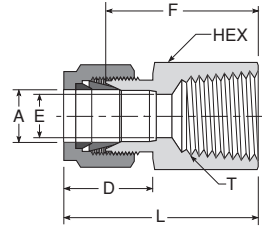
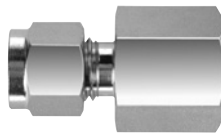

PART No.	A Tube OD	Hex Tube Nut	D	T NPT	E Min Orifice	F	L OAL	Hex Body
DSA-5-2-*	5/16"	5/8"	0.73	1/8"	0.25	0.97	1.26	9/16"
DSA-5-4-*	5/16"	5/8"	0.73	1/4"	0.25	1.16	1.45	3/4"
DSA-6-2-*	3/8"	11/16"	0.76	1/8"	0.28	1.00	1.29	5/8"
DSA-6-4-*	3/8"	11/16"	0.76	1/4"	0.28	1.19	1.48	3/4"
DSA-6-6-*	3/8"	11/16"	0.76	3/8"	0.28	1.25	1.54	7/8"
DSA-6-8-*	3/8"	11/16"	0.76	1/2"	0.28	1.44	1.73	1 1/16"
DSA-6-12-*	3/8"	11/16"	0.76	3/4"	0.28	1.55	1.84	1 5/16"
DSA-6-16-*	3/8"	11/16"	0.76	1"	0.28	1.87	2.17	1 5/8"
DSA-8-2-*	1/2"	7/8"	0.86	1/8"	0.41	1.00	1.41	1 1/16"
DSA-8-4-*	1/2"	7/8"	0.86	1/4"	0.41	1.25	1.64	1 3/16"
DSA-8-6-*	1/2"	7/8"	0.86	3/8"	0.41	1.25	1.64	7/8"
DSA-8-8-*	1/2"	7/8"	0.86	1/2"	0.41	1.44	1.83	1 1/16"
DSA-8-12-*	1/2"	7/8"	0.86	3/4"	0.41	1.50	1.89	1 5/16"
DSA-8-16-*	1/2"	7/8"	0.86	1"	0.41	1.87	2.25	1 5/8"
DSA-10-6-*	5/8"	1"	0.86	3/8"	0.50	1.25	1.64	1 5/16"
DSA-10-8-*	5/8"	1"	0.86	1/2"	0.50	1.44	1.83	1 1/16"
DSA-10-12-*	5/8"	1"	0.86	3/4"	0.50	1.50	1.90	1 5/16"
DSA-12-6-*	3/4"	1 1/8"	0.86	3/8"	0.62	1.34	1.74	1 1/16"
DSA-12-8-*	3/4"	1 1/8"	0.86	1/2"	0.62	1.44	1.83	1 1/16"
DSA-12-12-*	3/4"	1 1/8"	0.86	3/4"	0.62	1.50	1.89	1 5/16"
DSA-14-12-*	7/8"	1 1/4"	0.86	3/4"	0.72	1.56	1.95	1 5/16"
DSA-16-12-*	1"	1 1/2"	1.04	3/4"	0.88	1.62	2.10	1 3/8"
DSA-16-16-*	1"	1 1/2"	1.04	1"	0.88	1.97	2.45	1 5/8"

* Add Suffix "SS" for 316 Stainless Steel or "B" for Brass.

BULKHEAD MALE NPT CONNECTOR

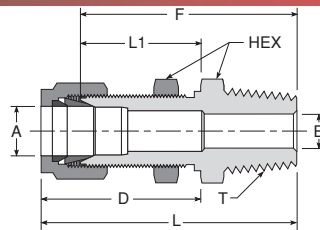
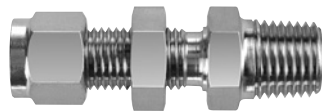

PART No.	A Tube OD	Hex Tube Nut	D	T NPT	E Min Orifice	F	L1	Hex Body	L OAL	Panel Hole Drill Size	Max Panel Thickness
DSC-2-2-*	1/8"	5/16"	1.24	1/8"	0.09	1.57	0.97	1/2"	1.83	21/64"	0.50
DSC-4-2-*	1/4"	9/16"	1.32	1/8"	0.19	1.66	1.03	5/8"	1.95	29/64"	0.40
DSC-4-4-*	1/4"	9/16"	1.32	1/4"	0.19	1.84	1.03	5/8"	2.11	29/64"	0.40
DSC-6-4-*	3/8"	11/16"	1.45	1/4"	0.28	1.97	1.16	3/4"	2.26	37/64"	0.44
DSC-6-6-*	3/8"	11/16"	1.45	3/8"	0.28	1.97	1.16	3/4"	2.26	37/64"	0.44
DSC-6-8-*	3/8"	11/16"	1.45	1/2"	0.28	2.30	1.16	7/8"	2.60	37/64"	0.44
DSC-8-6-*	1/2"	7/8"	1.63	3/8"	0.41	2.09	1.25	15/16"	2.49	49/64"	0.50
DSC-8-8-*	1/2"	7/8"	1.63	1/2"	0.41	2.90	1.25	15/16"	2.66	49/64"	0.50
DSC-12-12-*	3/4"	1 1/8"	1.85	3/4"	0.62	2.60	1.47	1 3/16"	3.00	1 1/64"	0.66
DSC-16-16-*	1"	1 1/2"	2.28	1"	0.88	3.19	1.78	1 5/8"	3.67	1 21/64"	0.75

* Add Suffix "SS" for 316 Stainless Steel or "B" for Brass.

Dimensions are provided in inches and are for reference only, subject to change. Dimensions shown are with the nut in the finger-tight position.

BULKHEAD ADAPTER

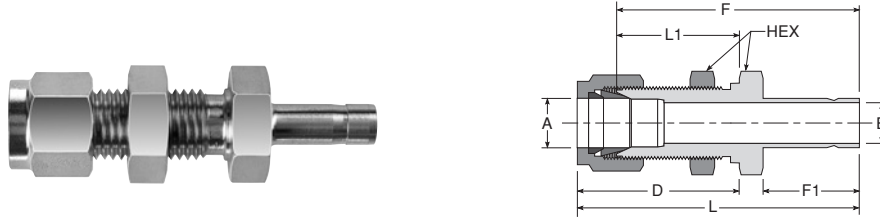

PART No.	A Tube OD	Hex Tube Nut	D	E Min Orifice	F	F1	L1	L OAL	Hex Body	Panel Hole Drill Size	Max Panel Thickness
DSE-2-*	1/8"	5/16"	1.23	0.09	1.69	0.55	0.97	1.95	1/2"	21/64"	0.50
DSE-4-*	1/4"	9/16"	1.32	0.19	1.91	0.65	1.03	2.20	5/8"	29/64"	0.40
DSE-6-*	3/8"	11/16"	1.45	0.28	2.12	0.71	1.16	2.41	3/4"	37/64"	0.44
DSE-8-*	1/2"	7/8"	1.64	0.39	2.47	0.93	1.26	2.87	15/16"	49/64"	0.50

* Add Suffix "SS" for 316 Stainless Steel or "B" for Brass.

BULKHEAD UNION ELBOW

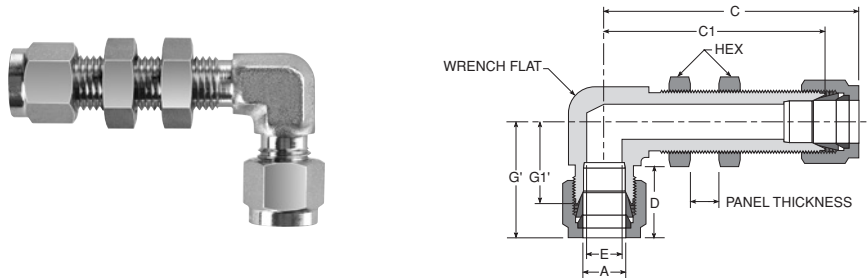

PART No.	A Tube OD	Hex Tube Nut	D	C	C1	E Min Orifice	G	G1	Wrench Flat	Hex Panel Nut	Panel Hole Drill Size	Max Panel Thickness
DSL-2-*	1/8"	7/16"	0.60	1.93	1.67	0.09	0.88	0.62	3/8"	1/2"	21/64"	0.60
DSL-3-*	3/16"	1/2"	0.63	2.03	1.77	0.12	1.01	0.75	1/2"	9/16"	25/64"	0.61
DSL-4-*	1/4"	9/16"	0.70	2.10	1.81	0.19	1.07	0.79	1/2"	5/8"	29/64"	0.61
DSL-5-*	5/16"	5/8"	0.73	2.30	2.01	0.25	1.17	0.89	5/8"	11/16"	33/64"	0.74
DSL-6-*	3/8"	11/16"	0.76	2.36	2.07	0.28	1.20	0.91	5/8"	3/4"	37/64"	0.74
DSL-8-*	1/2"	7/8"	0.86	2.67	2.27	0.41	1.38	0.94	13/16"	15/16"	49/64"	0.74
DSL-10-*	5/8"	1"	0.86	2.82	2.42	0.50	1.46	1.06	15/16"	11/16"	57/64"	0.50
DSL-12-*	3/4"	1 1/8"	0.86	3.08	2.68	0.62	1.51	1.11	1 1/16"	1 3/16"	1 3/16"	0.66

* Add Suffix "SS" for 316 Stainless Steel or "B" for Brass.

Dimensions are provided in inches and are for reference only, subject to change. Dimensions shown are with the nut in the finger-tight position.

BULKHEAD FEMALE NPT CONNECTOR

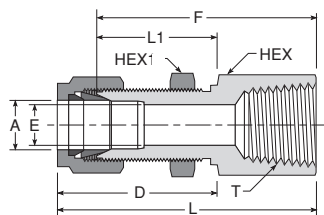
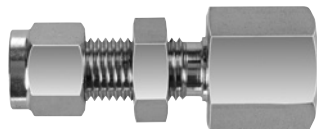

PART No.	A Tube OD	Hex Tube Nut	D	L1	T NPT	E Min Orifice	F	L OAL	Hex Body	Hex Panel Nut	Panel Hole Drill Size	Max Panel Thickness
DSS-2-2-*	1/8"	7/16"	1.23	0.97	1/8"	0.09	1.50	1.76	9/16"	1/2"	21/64"	0.50
DSS-4-2-*	1/4"	9/16"	1.32	1.03	1/8"	0.19	1.56	1.85	5/8"	5/8"	29/64"	0.40
DSS-4-4-*	1/4"	9/16"	1.32	1.03	1/4"	0.19	1.75	2.04	3/4"	5/8"	29/64"	0.40
DSS-6-4-*	3/8"	11/16"	1.45	1.16	1/4"	0.28	1.88	2.17	3/4"	3/4"	37/64"	0.44
DSS-6-6-*	3/8"	11/16"	1.45	1.16	3/8"	0.28	1.93	2.22	7/8"	3/4"	37/64"	0.44
DSS-6-8-*	3/8"	11/16"	1.45	1.16	1/2"	0.28	2.13	2.43	1 1/16"	3/4"	37/64"	0.44
DSS-8-6-*	1/2"	7/8"	1.65	1.25	3/8"	0.41	2.03	2.43	15/16"	15/16"	49/64"	0.50
DSS-8-8-*	1/2"	7/8"	1.65	1.25	1/2"	0.41	2.22	2.62	1 1/16"	15/16"	49/64"	0.50

* Add Suffix "SS" for 316 Stainless Steel or "B" for Brass.

BULKHEAD UNION

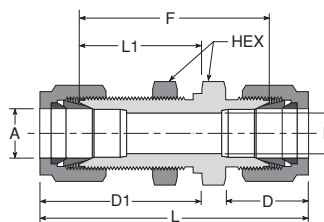
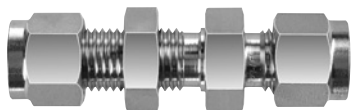

PART No.	A Tube OD	Hex Tube Nut	D1	L1	E Min Orifice	F	D	L OAL	Hex Body	Panel Hole Drill Size	Max Panel Thickness
DSU-2-*	1/8"	7/16"	1.23	0.97	0.09	1.50	0.60	2.02	1/2"	21/64"	0.50
DSU-3-*	3/16"	1/2"	1.27	1.00	0.12	1.59	0.63	2.11	9/16"	25/64"	0.50
DSU-4-*	1/4"	9/16"	1.32	1.03	0.19	1.69	0.70	2.27	5/8"	29/64"	0.40
DSU-5-*	5/16"	5/8"	1.42	1.12	0.25	1.81	0.73	2.39	11/16"	33/64"	0.43
DSU-6-*	3/8"	11/16"	1.46	1.16	0.28	1.88	0.76	2.46	3/4"	37/64"	0.44
DSU-8-*	1/2"	7/8"	1.67	1.25	0.41	2.00	0.86	2.80	15/16"	49/64"	0.50
DSU-10-*	5/8"	1"	1.69	1.28	0.50	2.07	0.86	2.87	1 1/16"	57/64"	0.50
DSU-12-*	3/4"	1 1/8"	1.87	1.47	0.63	2.31	0.86	3.11	1 3/16"	1 1/64"	0.66
DSU-16-*	1"	1 1/4"	2.28	1.78	0.80	2.81	1.04	3.79	1 5/8"	1 21/64"	0.75

* Add Suffix "SS" for 316 Stainless Steel or "B" for Brass.

UNION TEE

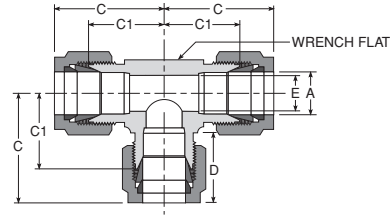
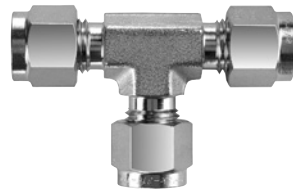

PART No.	A Tube OD	Hex Tube Nut	D	E Min Orifice	C	C1	Wrench Flat
DTA-1-*	1/16"	5/16"	0.44	0.05	0.71	0.55	3/8"
DTA-2-*	1/8"	7/16"	0.60	0.09	0.88	0.62	3/8"
DTA-3-*	3/16"	1/2"	0.63	0.12	1.01	0.75	1/2"
DTA-4-*	1/4"	9/16"	0.70	0.19	1.07	0.77	1/2"
DTA-5-*	5/16"	5/8"	0.73	0.25	1.17	0.88	5/8"
DTA-6-*	3/8"	11/16"	0.76	0.28	1.20	0.91	5/8"
DTA-8-*	1/2"	7/8"	0.86	0.41	1.40	0.99	13/16"
DTA-10-*	5/8"	1"	0.86	0.50	1.47	1.06	15/16"
DTA-12-*	3/4"	1 1/8"	0.86	0.62	1.52	1.11	1 1/16"
DTA-14-*	7/8"	1 1/4"	0.86	0.72	1.68	1.28	1 1/4"
DTA-16-*	1"	1 1/2"	1.04	0.88	1.81	1.31	1 5/16"

* Add Suffix "SS" for 316 Stainless Steel or "B" for Brass.

FEMALE NPT RUN TEE

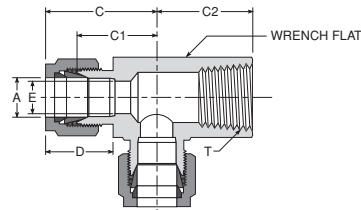
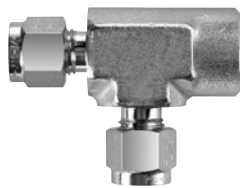

PART No.	A Tube OD	Hex Tube Nut	D	T NPT	E Min Orifice	C	C1	C2	Wrench Flat
DTF-2-2-*	1/8"	7/16"	0.60	1/8"	0.09	0.96	0.70	0.75	5/8"
DTF-4-2-*	1/4"	9/16"	0.70	1/8"	0.19	1.05	0.76	0.75	5/8"
DTF-4-4-*	1/4"	9/16"	0.70	1/4"	0.19	1.17	0.88	0.88	13/16"
DTF-6-4-*	3/8"	11/16"	0.76	1/4"	0.28	1.23	0.94	0.88	13/16"
DTF-6-6-*	3/8"	11/16"	0.76	3/8"	0.28	1.33	1.03	0.89	15/16"
DTF-8-6-*	1/2"	7/8"	0.86	3/8"	0.41	1.43	1.02	0.88	15/16"
DTF-8-8-*	1/2"	7/8"	0.86	1/2"	0.41	1.53	1.11	1.12	1 1/16"
DTF-12-12-*	3/4"	1 1/8"	0.86	3/4"	0.62	1.66	1.25	1.25	1 5/16"

* Add Suffix "SS" for 316 Stainless Steel or "B" for Brass.

FEMALE NPT BRANCH TEE

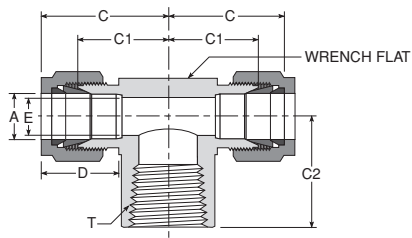
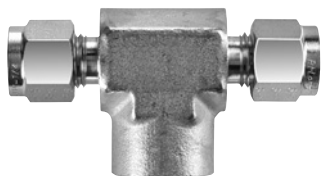

PART No.	A Tube OD	Hex Tube Nut	D	T NPT	E Min Orifice	C	C1	C2	Wrench Flat
DTH-2-2-*	1/8"	7/16"	0.60	1/8"	0.09	0.96	0.70	0.75	5/8"
DTH-4-2-*	1/4"	9/16"	0.70	1/8"	0.19	1.05	0.76	0.75	5/8"
DTH-4-4-*	1/4"	9/16"	0.70	1/4"	0.19	1.17	0.88	0.88	13/16"
DTH-6-4-*	3/8"	11/16"	0.76	1/4"	0.28	1.23	0.94	0.88	13/16"
DTH-6-6-*	3/8"	11/16"	0.76	3/8"	0.28	1.32	1.02	0.88	15/16"
DTH-8-4-*	1/2"	7/8"	0.86	1/4"	0.41	1.40	0.99	0.88	13/16"
DTH-8-6-*	1/2"	7/8"	0.86	3/8"	0.41	1.43	1.02	0.88	15/16"
DTH-8-8-*	1/2"	7/8"	0.86	1/2"	0.41	1.53	1.12	1.12	11/16"
DTH-8-12-*	1/2"	7/8"	0.86	3/4"	0.41	1.66	1.25	1.25	15/16"
DTH-10-8-*	5/8"	1"	0.86	1/2"	0.50	1.52	1.12	1.12	11/16"
DTH-12-12-*	3/4"	1 1/8"	0.86	3/4"	0.62	1.66	1.25	1.25	15/16"
DTH-14-12-*	7/8"	1 1/4"	0.86	3/4"	0.72	1.68	1.28	1.25	15/16"

* Add Suffix "SS" for 316 Stainless Steel or "B" for Brass.

TUBE INSERT

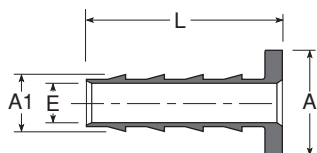

Used with soft polymer tubing

PART No.	A Tube OD	A1 Tube ID	E Min Orifice	L OAL
DTI-3-2-*	3/16"	1/8"	0.09	0.47
DTI-4-2-*	1/4"	1/8"	0.09	0.47
DTI-4-3-*	1/4"	3/16"	0.14	0.47
DTI-5-4-*	5/16"	1/4"	0.12	0.56
DTI-6-3-*	3/8"	3/16"	0.12	0.56
DTI-6-4-*	3/8"	1/4"	0.19	0.56
DTI-8-6-*	1/2"	3/8"	0.31	0.75
DTI-10-8-*	5/8"	1/2"	0.44	0.86
DTI-16-12-*	1"	3/4"	0.69	0.94

* Add Suffix "SS" for 316 Stainless Steel or "B" for Brass.

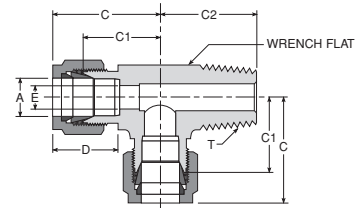
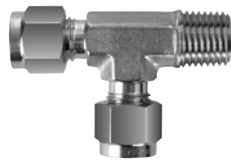
MALE NPT RUN TEE

PART No.	A Tube OD	Hex Tube Nut	D	T NPT	E Min Orifice	C	C1	C2	Wrench Flat
DTK-2-2-*	1/8"	7/16"	0.60	1/8"	0.09	0.93	0.67	0.72	7/16"
DTK-2-4-*	1/8"	7/16"	0.60	1/4"	0.09	0.97	0.71	0.98	1/2"
DTK-3-2-*	3/16"	1/2"	0.63	1/8"	0.12	1.01	0.75	0.74	1/2"
DTK-4-2-*	1/4"	9/16"	0.70	1/8"	0.19	1.07	0.78	0.74	1/2"
DTK-4-4-*	1/4"	9/16"	0.70	1/4"	0.19	1.07	0.78	0.93	1/2"
DTK-4-6-*	1/4"	9/16"	0.70	3/8"	0.19	1.18	0.89	1.12	5/8"
DTK-5-2-*	5/16"	5/8"	0.73	1/8"	0.25	1.17	0.88	0.82	5/8"
DTK-5-4-*	5/16"	5/8"	0.73	1/4"	0.25	1.18	0.88	1.00	5/8"
DTK-6-4-*	3/8"	11/16"	0.76	1/4"	0.28	1.20	0.91	1.00	5/8"
DTK-6-6-*	3/8"	11/16"	0.76	3/8"	0.28	1.24	0.94	1.11	11/16"
DTK-8-6-*	1/2"	7/8"	0.86	3/8"	0.41	1.40	0.98	1.09	13/16"
DTK-8-8-*	1/2"	7/8"	0.86	1/2"	0.41	1.43	1.20	1.31	13/16"
DTK-10-8-*	5/8"	1"	0.86	1/2"	0.50	1.48	1.06	1.35	15/16"
DTK-12-12-*	3/4"	1 1/8"	0.86	3/4"	0.62	1.52	1.11	1.41	1 1/4"
DTK-14-12-*	7/8"	1 1/4"	0.86	3/4"	0.72	1.68	1.28	1.65	1 5/16"

* Add Suffix "SS" for 316 Stainless Steel or "B" for Brass.

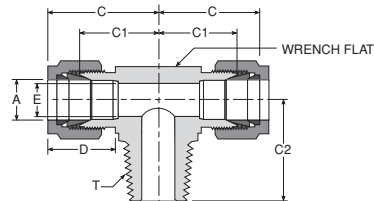
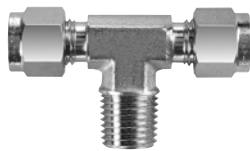
MALE NPT BRANCH TEE

PART No.	A Tube OD	Hex Tube Nut	D	T NPT	E Min Orifice	C	C1	C2	Wrench Flat
DTN-2-2-*	1/8"	7/16"	0.60	1/8"	0.09	0.93	0.67	0.72	7/16"
DTN-2-4-*	1/8"	7/16"	0.60	1/4"	0.09	0.97	0.71	0.93	1/2"
DTN-3-2-*	3/16"	1/2"	0.63	1/8"	0.12	1.00	0.75	0.75	1/2"
DTN-4-2-*	1/4"	9/16"	0.70	1/8"	0.19	1.07	0.78	0.75	1/2"
DTN-4-4-*	1/4"	9/16"	0.70	1/4"	0.19	1.07	0.78	0.93	1/2"
DTN-4-8-*	1/4"	9/16"	0.70	1/2"	0.19	1.26	0.96	1.32	13/16"
DTN-5-2-*	5/16"	5/8"	0.73	1/8"	0.19	1.17	0.88	0.82	5/8"
DTN-5-4-*	5/16"	5/8"	0.73	1/4"	0.25	1.18	0.88	1.00	5/8"
DTN-6-4-*	3/8"	11/16"	0.76	1/4"	0.28	1.20	0.91	1.00	5/8"
DTN-6-6-*	3/8"	11/16"	0.76	3/8"	0.28	1.20	0.94	1.11	11/16"
DTN-8-6-*	1/2"	7/8"	0.86	3/8"	0.41	1.40	0.98	1.09	13/16"
DTN-8-8-*	1/2"	7/8"	0.86	1/2"	0.41	1.43	1.02	1.31	13/16"
DTN-8-12-*	1/2"	7/8"	0.86	3/4"	0.41	1.52	1.11	1.40	1 1/16"
DTN-10-8-*	5/8"	1"	0.86	1/2"	0.50	1.47	1.06	1.34	15/16"
DTN-12-12-*	3/4"	1 1/8"	0.86	3/4"	0.62	1.52	1.11	1.40	1 1/16"
DTN-14-12-*	7/8"	1 1/4"	0.86	3/4"	0.72	1.68	1.28	1.65	1 1/4"

* Add Suffix "SS" for 316 Stainless Steel or "B" for Brass.

Dimensions are provided in inches and are for reference only, subject to change. Dimensions shown are with the nut in the finger-tight position.

REDUCING UNION TEE

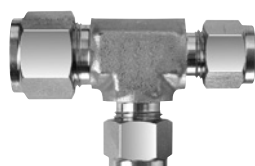

(Type 2 Shown)

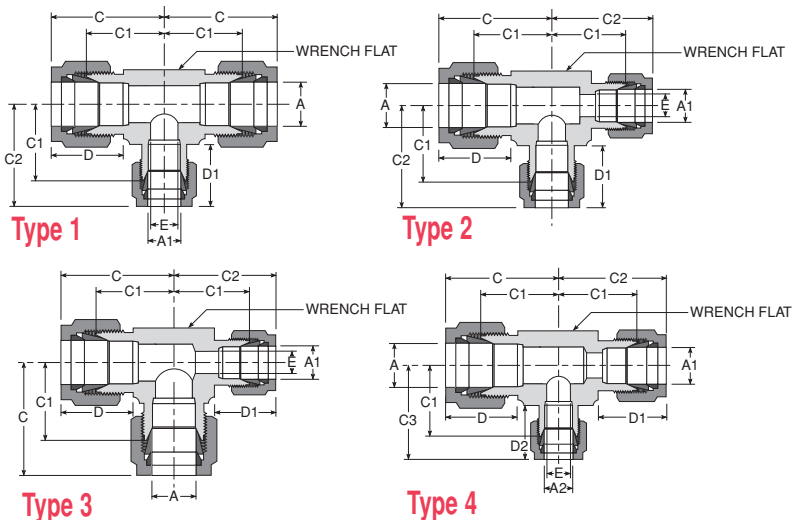

TYPE 1

PART No.	A Tube OD	Hex Tube Nut	D	E Min Orifice	A1 Tube OD	Hex 1 Tube Nut	D1	C	C1	C2	Wrench Flat
DTR-6-6-4-*	3/8"	11/16"	0.76	0.19	1/4"	9/16"	0.70	1.20	0.91	1.20	5/8"
DTR-8-8-4-*	1/2"	7/8"	0.86	0.19	1/4"	9/16"	0.70	1.39	0.98	1.28	13/16"
DTR-8-8-6-*	1/2"	7/8"	0.86	0.28	3/8"	11/16"	0.76	1.39	0.98	1.28	13/16"
DTR-10-10-6-*	5/8"	1"	0.86	0.28	3/8"	11/16"	0.76	1.47	1.06	1.36	15/16"
DTR-12-12-6-*	3/4"	1 1/8"	0.86	0.28	3/8"	11/16"	0.76	1.52	1.11	1.41	1 1/16"
DTR-12-12-8-*	3/4"	1 1/8"	0.86	0.41	1/2"	7/8"	0.86	1.52	1.11	1.52	1 1/16"
DTR-16-16-6-*	1"	1 1/2"	1.04	0.28	3/8"	11/16"	0.76	1.81	1.31	1.61	1 5/16"
DTR-16-16-8-*	1"	1 1/2"	1.04	0.41	1/2"	7/8"	0.86	1.81	1.31	1.72	1 5/16"
DTR-16-16-12-*	1"	1 1/2"	1.04	0.62	3/4"	1 1/8"	0.86	1.81	1.31	1.72	1 5/16"

TYPE 2

PART No.	A Tube OD	Hex Tube Nut	D	E Min Orifice	A1 Tube OD	Hex 1 Tube Nut	D1	C	C1	C2	Wrench Flat
DTR-10-8-8-*	5/8"	1"	0.86	0.41	1/2"	7/8"	0.86	1.47	1.06	1.47	15/16"
DTR-12-6-6-*	3/4"	1 1/8"	0.86	0.28	3/8"	11/16"	0.76	1.52	1.11	1.41	1 1/8"
DTR-12-10-10-*	3/4"	1 1/8"	0.86	0.50	5/8"	1"	0.86	1.52	1.11	1.52	1 1/8"

TYPE 3

PART No.	A Tube OD	Hex Tube Nut	D	E Min Orifice	A1 Tube OD	Hex 1 Tube Nut	D1	C	C1	C2	Wrench Flat
DTR-8-6-8-*	1/2"	7/8"	0.86	0.28	3/8"	11/16"	0.76	1.39	0.98	1.28	1 1/8"
DTR-16-12-16-*	1"	1 1/8"	1.04	0.62	3/4"	1 1/8"	0.86	1.81	1.31	1.72	1 5/16"

TYPE 4

PART No.	A Tube OD	Hex Tube Nut	D	E Min	A1 Tube OD	Hex 1 Tube Nut	D1	A2 Tube OD	Hex 2 Tube Nut	D2	C	C1	C2	C3	Wrench Flat
DTR-10-8-6-*	5/8"	1"	0.86	0.28	1/2"	7/8"	0.86	3/8"	11/16"	0.76	1.47	1.06	1.11	1.47	15/16"
DTR-12-8-6-*	3/4"	1 1/8"	0.86	0.28	1/2"	7/8"	0.86	3/8"	"	0.76	1.52	1.11	1.06	1.52	1 1/16"
DTR-16-12-6-*	1"	1 1/2"	1.04	0.28	3/4"	1 1/8"	0.86	3/8"	11/16"	0.76	1.81	1.31	1.11	1.72	1 5/16"

* Add Suffix "SS" for 316 Stainless Steel or "B" for Brass.

Dimensions are provided in inches and are for reference only, subject to change. Dimensions shown are with the nut in the finger-tight position.

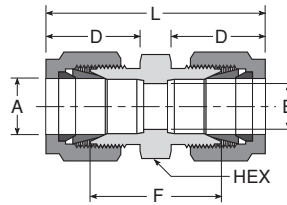
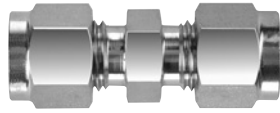
UNION

PART No.	A Tube OD	Hex Tube Nut	D	E Min Orifice	F	L OAL	Hex Body
DUA-1-*	1/16"	5/16"	0.44	0.05	0.69	0.99	5/16"
DUA-2-*	1/8"	7/16"	0.60	0.09	0.88	1.40	7/16"
DUA-3-*	3/16"	1/2"	0.63	0.12	0.95	1.47	7/16"
DUA-4-*	1/4"	9/16"	0.70	0.19	1.03	1.61	1/2"
DUA-5-*	5/16"	5/8"	0.73	0.25	1.11	1.69	9/16"
DUA-6-*	3/8"	11/16"	0.76	0.28	1.19	1.78	5/8"
DUA-8-*	1/2"	7/8"	0.86	0.41	1.22	2.02	13/16"
DUA-10-*	5/8"	1"	0.86	0.50	1.25	2.05	15/16"
DUA-12-*	3/4"	1 1/8"	0.86	0.62	1.31	2.11	1 1/16"
DUA-14-*	7/8"	1 1/4"	0.86	0.72	1.37	2.17	1 3/16"
DUA-16-*	1"	1 1/2"	1.04	0.88	1.59	2.58	1 3/16"

* Add Suffix "SS" for 316 Stainless Steel or "B" for Brass.

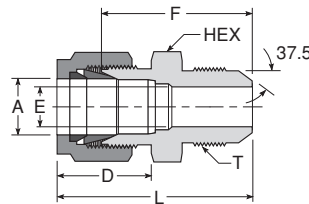
AN 37° FLARE UNION

PART No.	A Tube OD	Hex Tube Nut	D	AN Tube Size	T Straight Thread	E Min Orifice	F	L OAL	Hex Body
DUC-2-2-*	1/8"	7/16"	0.60	1/8"	5/16"-24	0.09	0.99	1.24	7/16"
DUC-2-4-*	1/8"	7/16"	0.60	1/4"	7/16"-20	0.09	1.12	1.38	1/2"
DUC-4-4-*	1/4"	9/16"	0.70	1/4"	7/16"-20	0.18	1.19	1.48	1/2"
DUC-5-5-*	5/16"	5/8"	0.73	5/16"	1/2"-20	0.23	1.22	1.52	9/16"
DUC-6-4-*	3/8"	11/16"	0.76	1/4"	7/16"-20	0.28	1.27	1.56	5/8"
DUC-6-6-*	3/8"	11/16"	0.76	3/8"	9/16"-18	0.28	1.27	1.56	5/8"
DUC-8-8-*	1/2"	7/8"	0.86	1/2"	3/4"-16	0.40	1.40	1.81	13/16"
DUC-10-8-*	5/8"	1"	0.86	1/2"	3/4"-16	0.50	1.44	1.84	15/16"
DUC-10-10-*	5/8"	1"	0.86	5/8"	7/8"-14	0.48	1.54	1.95	15/16"
DUC-12-12-*	3/4"	1 1/8"	0.86	3/4"	1 1/16"-12	0.61	1.74	2.14	1 1/8"
DUC-16-16-*	1"	1 1/2"	1.04	1"	1 5/16"-12	0.89	1.94	2.43	1 3/16"

* Add Suffix "SS" for 316 Stainless Steel or "B" for Brass.

BULKHEAD AN 37° FLARE UNION

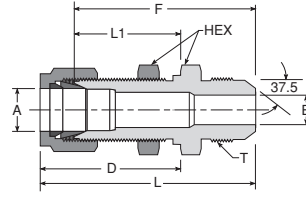
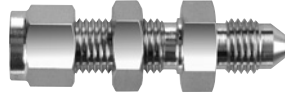

PART No.	A Tube OD	Hex Tube Nut	D	AN Tube Size	T Straight Thread	E Min Orifice	F	L OAL	L1	Hex Body	Panel Hole Drill Size	Max Panel Thickness
DUE-4-4-*	1/4"	17.42	0.70	1/4"	7/16"-20	0.18	1.83	2.12	1.03	5/8"	29/64"	0.40
DUE-6-4-*	3/8"	19.23	0.76	1/4"	7/16"-20	0.28	1.96	2.26	1.16	3/4"	37/64"	0.44
DUE-6-6-*	3/8"	19.23	0.76	3/8"	9/16"-18	0.28	1.96	2.25	1.16	3/4"	37/64"	0.44
DUE-8-8-*	1/2"	21.54	0.86	1/2"	3/4"-16	0.40	2.19	2.59	1.26	15/16"	49/64"	0.50
DUE-12-12-*	3/4"	21.6	0.86	3/4"	1 1/16"-12	0.61	2.71	3.11	1.47	1 3/16"	1 1/16"	0.66
DUE-16-16-*	1"	25.4	1.04	1"	1 5/16"-12	0.88	3.16	3.64	1.78	1 5/8"	1 21/64"	0.75

* Add Suffix "SS" for 316 Stainless Steel or "B" for Brass.

REDUCING UNION

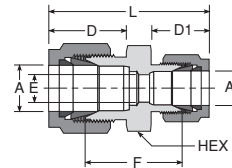
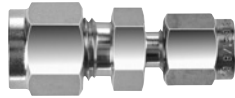

PART No.	A Tube OD	Hex Tube Nut	D	A1 Tube OD	Hex Tube Nut	D1	E Min Orifice	F	L OAL	Hex Body
DUR-2-1-*	1/8"	7/16"	0.60	1/16"	5/16"	0.44	0.05	0.81	1.22	7/16"
DUR-3-1-*	3/16"	1/2"	0.63	1/16"	5/16"	0.44	0.05	0.86	1.27	7/16"
DUR-3-2-*	3/16"	1/2"	0.63	1/8"	7/16"	0.60	0.09	0.92	1.44	7/16"
DUR-4-1-*	1/4"	9/16"	0.70	1/16"	5/16"	0.44	0.05	0.91	1.35	1/2"
DUR-4-2-*	1/4"	9/16"	0.70	1/8"	7/16"	0.60	0.09	0.97	1.52	1/2"
DUR-4-3-*	1/4"	9/16"	0.70	3/16"	1/2"	0.63	0.12	1.00	1.55	1/2"
DUR-5-4-*	5/16"	5/8"	0.73	1/4"	9/16"	0.70	0.19	1.08	1.66	9/16"
DUR-6-2-*	3/8"	11/16"	0.76	1/8"	7/16"	0.60	0.09	1.06	1.61	5/8"
DUR-6-4-*	3/8"	11/16"	0.76	1/4"	9/16"	0.70	0.19	1.12	1.70	5/8"
DUR-6-5-*	3/8"	11/16"	0.76	5/16"	5/8"	0.73	0.25	1.16	1.74	5/8"
DUR-8-2-*	1/2"	7/8"	0.86	1/8"	7/16"	0.60	0.09	1.13	1.78	13/16"
DUR-8-4-*	1/2"	7/8"	0.86	1/4"	9/16"	0.70	0.19	1.16	1.85	13/16"
DUR-8-6-*	1/2"	7/8"	0.86	3/8"	11/16"	0.76	0.28	1.22	1.91	13/16"
DUR-10-6-*	5/8"	1"	0.86	3/8"	11/16"	0.76	0.28	1.25	1.94	15/16"
DUR-10-8-*	5/8"	1"	0.86	1/2"	7/8"	0.86	0.41	1.25	2.05	15/16"
DUR-12-4-*	3/4"	1 1/8"	0.86	1/4"	9/16"	0.70	0.19	1.25	1.93	1 1/16"
DUR-12-6-*	3/4"	1 1/8"	0.86	3/8"	11/16"	0.76	0.28	1.31	2.00	1 1/16"
DUR-12-8-*	3/4"	1 1/8"	0.86	1/2"	7/8"	0.86	0.41	1.31	2.11	1 1/16"
DUR-12-10-*	3/4"	1 1/8"	0.86	5/8"	1"	0.86	0.50	1.31	2.11	1 1/16"
DUR-14-12-*	7/8"	1 1/4"	0.86	3/4"	1 1/8"	0.86	0.62	1.38	2.14	1 3/16"
DUR-16-8-*	1"	1 1/2"	1.04	1/2"	7/8"	0.86	0.41	1.54	2.40	1 3/8"
DUR-16-12-*	1"	1 1/2"	1.04	3/4"	1 1/4"	0.86	0.62	1.50	2.39	1 3/8"

* Add Suffix "SS" for 316 Stainless Steel or "B" for Brass.

UNION CROSS

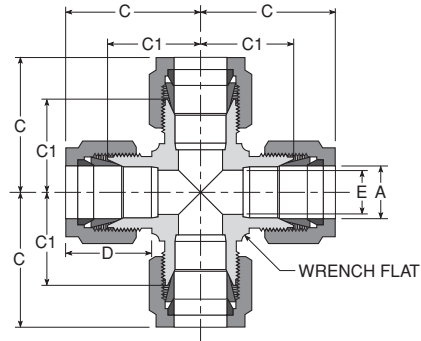
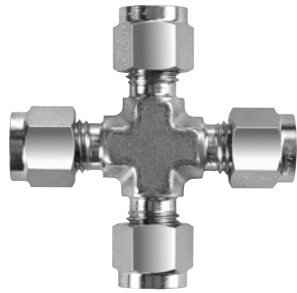

PART No.	A Tube OD	Hex Tube Nut	D	E Min Orifice	C	C1	Wrench Flat
DXA-2-*	1/8"	7/16"	0.60	0.09	0.88	0.62	3/8"
DXA-3-*	3/16"	1/2"	0.63	0.12	1.01	0.75	1/2"
DXA-4-*	1/4"	9/16"	0.70	0.19	1.07	0.78	1/2"
DXA-5-*	5/16"	5/8"	0.73	0.25	1.17	0.88	5/8"
DXA-6-*	3/8"	11/16"	0.76	0.28	1.20	0.91	5/8"
DXA-8-*	1/2"	7/8"	0.86	0.41	1.40	0.98	13/16"
DXA-10-*	5/8"	1"	0.86	0.50	1.47	1.06	15/16"
DXA-12-*	3/4"	1 1/8"	0.86	0.62	1.52	1.11	1 1/16"
DXA-16-*	1"	1 1/2"	1.04	0.88	1.81	1.31	1 5/16"

* Add Suffix "SS" for 316 Stainless Steel or "B" for Brass.

Dimensions are provided in inches and are for reference only, subject to change. Dimensions shown are with the nut in the finger-tight position.

A GLOBAL CONNECTION



BI-Lok Tube Fittings are manufactured in four State-of-the-art facilities, in two countries, and are marketed worldwide through a network of authorized stocking distributors and representatives.

In today's business environment, success is dependant upon the true creation of value.

For over 75 years, Generant, a leading designer and manufacturer of pressure and flow control products, has built a reputation synonymous with innovative and advanced design, application engineering expertise, quality manufacturing and unparalleled service.

In this tradition, BI-Lok Series D Dual Ferrule Tube Fittings represent a high quality, cost effective, design solution to instrument grade fluid connector applications.

BI-Lok® is a registered trademark of the Ihara Science Corporation, Tokyo, Japan.



www.generant.com