

Waste Pre-Shredders from Metso Waste Recycling
M&J PreShred 6000M

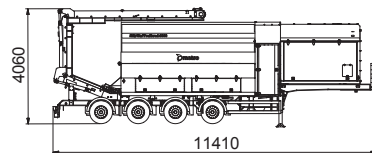

M&J PreShred 6000M

Semi trailer

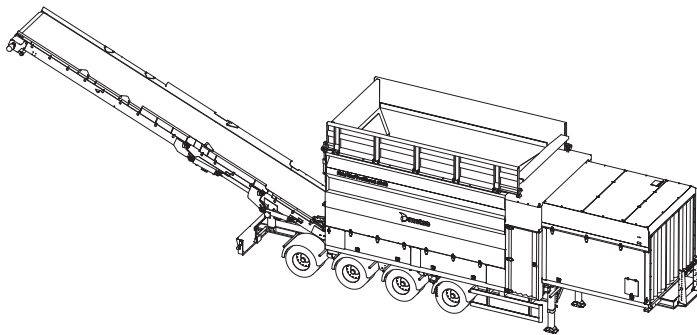
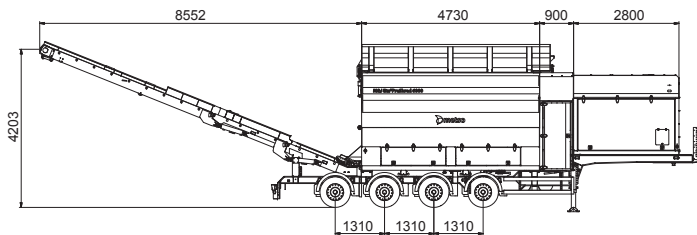

Crawler version

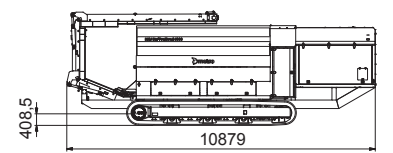
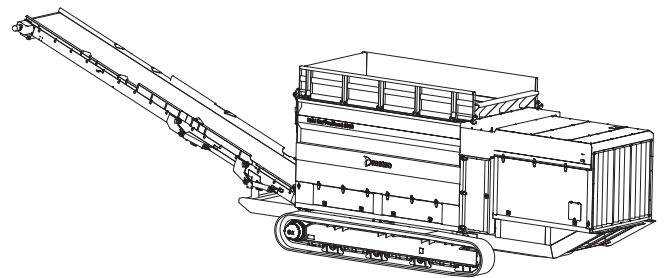
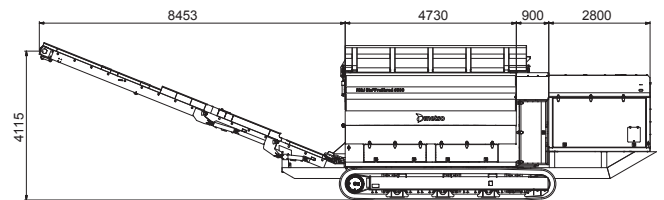

Semi trailer

Crawler

Specification				
Overall dimension std without hopper (LxWxH)	mm	11410 x 2710 x 4060	10879 x 3830 x 3994	
Weight (total included standard conveyer)	ton	50.0 – 52.5	60.0 – 62.5	
Standard colour	RAL	7011, 9002	7011, 9002	
Loading height (without hopper)	mm	3580	3519	
Cutting area	mm	3461 x 2400	3461 x 2400	
Power pack				
Diesel motor	kW/hp	403/540	403/540	
Electric control unit		PLC	PLC	
Drive principle		Double hydrostatic transmission	Double hydrostatic transmission	
Chassis				
Standard belt conveyer (LxW)	mm	13100 x 1200	13100 x 1200	
Discharge height	mm	4200	4115	

Cutting table

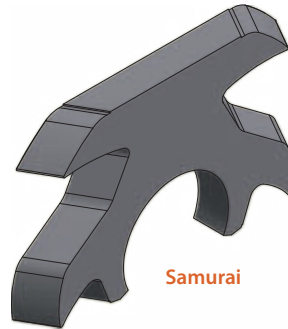

Cutting table 9 knives

Cutting table 16 knives

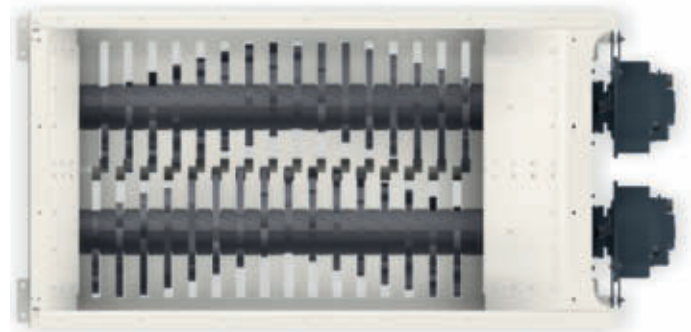
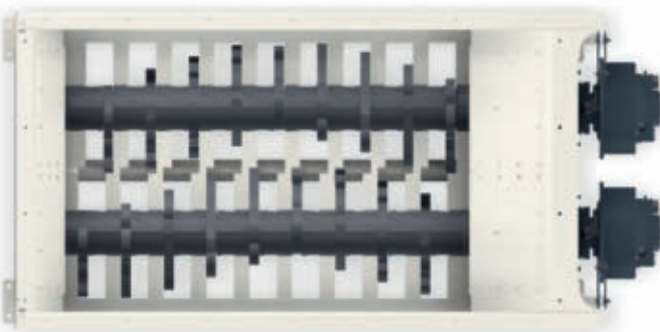

M&J PreShred 600M

Cutting Table		
Number of shafts		2
Rotating speed*	rpm	11-32
Number of knives		9 / 12 / 14 / 16
Number of counter knives		18 / 24 / 28 / 32
Cutting area (LxW)	mm	3461 x 2400
Weight	ton	24.5 – 27.7
Grain size **		
9 knives	mm	<450
12 knives	mm	<300
14 knives	mm	<200
16 knives	mm	<125
Capacity per hour ***		
Household waste	ton	Up to 200
Demolition wood	ton	Up to 100
Industrial waste	ton	Up to 50
Bulky waste	ton	Up to 70

* Standard ** 90% less than

*** Depending on loading, grain size and density of the input material



For more information, contact your local Metso Waste Recycling representative, or contact your dealer directly.

Metso Denmark A/S
Vejlevej 5
DK-8700 Horsens
Denmark
Tel: +45 7626 6400
Fax: +45 7626 6449
recycling.info.dk@metso.com

www.metso.com/recycling

We reserve the right to make changes and improvements without notice, "M&J PreShred 6000M". Metso Waste Recycling, March 2017