

MODEL 460-MR

DANGER!

HAZARDOUS VOLTAGES MAY BE PRESENT DURING INSTALLATION.

Electrical shock can cause death or serious injury.

Installation should be done by qualified personnel following all national, state and local electrical codes.



**BE SURE POWER IS DISCONNECTED PRIOR TO INSTALLATION!
FOLLOW NATIONAL, STATE AND LOCAL CODES.
READ THESE INSTRUCTIONS ENTIRELY BEFORE INSTALLATION.**

! WARNING !

UNEXPECTED OUTPUT ACTUATION CAN OCCUR.

Use hard-wired safety interlocks where personnel and/or equipment hazards exist.

Failure to follow this instruction can result in death, injury or equipment damage.

The Model 460-MR MotorSaver[®] is an auto-ranging voltage monitor designed to protect 3-phase motors regardless of size. The MotorSaver[®] is used on 190-480VAC, 50/60 Hz motors to protect from damage caused by single-phasing, low voltage, high voltage, phase reversal, and voltage unbalance. The Model 460-MR features an optional manual reset mode. In addition, when the MotorSaver[®] is in the manual reset mode and a fault condition occurs, the fault code will be displayed until the unit is manually reset, even if power is removed and reapplied.

CONNECTIONS

1. Mount the MotorSaver[®] in a convenient location in or near the motor control panel. If the location is wet or dusty, the MotorSaver[®] should be mounted in a NEMA 4 or 12 enclosure. The MotorSaver[®] can be mounted to a back panel using two #6 or #8 x 5/8 screws or can be snapped onto a DIN rail.
2. Connect L1, L2 and L3 on the MotorSaver's terminal strip to the LINE SIDE of the motor starter (see Figure 1).
3. Connect the output relay to the circuitry to be controlled. For motor control, connect the normally open contact in series with the magnetic coil of the motor starter as shown in Figure 1. For alarm operation, connect the normally closed contact in series with the control circuit as in Figure 2.
4. The Model 460-MR is shipped with a jumper across the two manual reset pins (see Fig. 3). This will allow the MotorSaver[®] to operate in automatic reset mode. To operate the MotorSaver[®] in manual reset mode, the jumper must be removed and replaced with an NO (normally open) pushbutton switch. A pre-assembled connector and 12" cable are shipped with each MotorSaver[®] (pushbutton not included). The connector must be plugged into the MotorSaver[®] with the locking tabs facing downward.



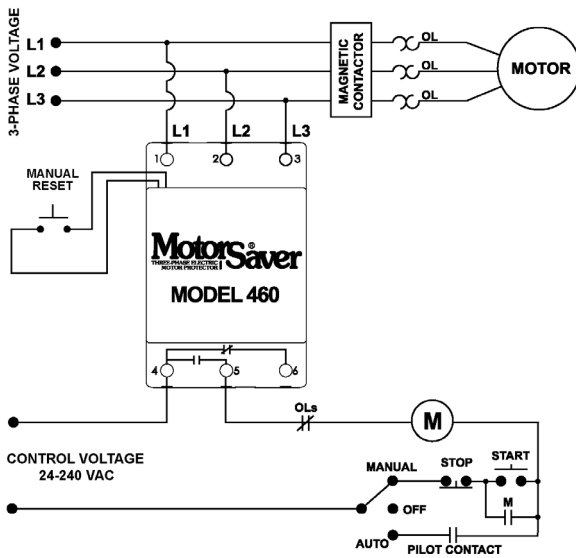

Figure 1. Control Wiring Diagram

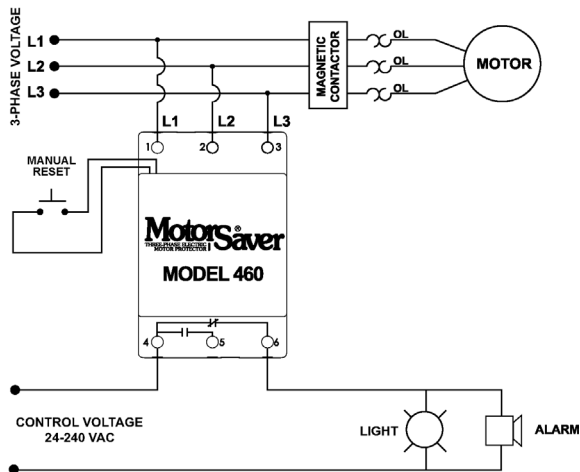

Figure 2. Alarm Wiring Diagram

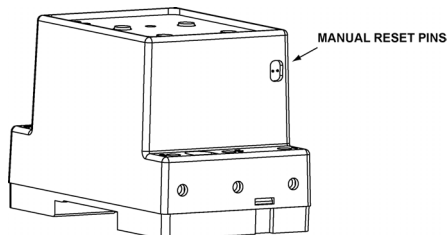

Figure 3. Manual Reset Connections

SETTINGS

1. Line voltage adjustment: Rotate the VOLTAGE ADJ. (VAC) to the nominal 3-phase line voltage feeding the motor to be protected.
2. Restart delay adjustment: Rotate the RESTART (SEC) adjustment to the desired position. The restart delay is the time between the MotorSaver® seeing acceptable voltage and the MotorSaver® closing its output contacts. For compressor applications, the restart delay should be set for the approximate time it takes for the head pressure to bleed off of the compressor. For other applications, the restart delay is typically set between 2 and 10 seconds.

NOTE: The restart delay adjustment is inoperative when configured for manual reset.

3. Trip delay adjustment: Rotate the TRIP DELAY (SEC) adjustment to the desired setting. This adjustment does not affect the trip delay on phasing faults. Typically, the trip delay adjustment is set between 1 and 5 seconds. In areas where voltage fluctuations are frequent, the trip delay adjustment may be set greater than 10 seconds.
4. Voltage unbalance adjustment: Rotate the UNBALANCE TRIP (NEMA%) adjustment to the desired unbalance trip level. The NEMA MG1 standard does not recommend operating a motor above 1% voltage unbalance without derating the motor. The NEMA MG1 standard also recommends against operating a motor above a 5% voltage unbalance under any circumstances. SymCom recommends consulting the motor manufacturer for specific tolerances.

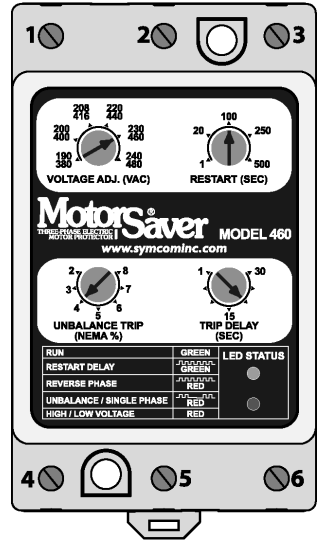

$$\text{Percent Unbalance} = \frac{\text{Maximum deviation from the average}}{\text{Average}} \times 100\%$$

Example: The measured line-to-line voltages are 203, 210, and 212.

$$\text{Average} = \frac{203 + 210 + 212}{3} = 208.3$$

The maximum deviation from the average is the largest difference between the average voltage (208.3) and any one voltage reading.

$$208.3 - 203 = 5.3 \quad 210 - 208.3 = 1.7 \quad 212 - 208.3 = 3.7$$

The maximum deviation from the average is 5.3.

$$\frac{5.3}{208.3} \times 100 = 2.5\% \text{ unbalance}$$

MANUAL RESET SWITCH OPERATION

The MotorSaver[®] always requires a manual reset after a power loss when operated in manual reset mode. If no faults are currently detected, and no faults were detected before power was removed, both lights will flash in unison until the reset button is pressed. When a fault is detected, the MotorSaver[®] will flash the fault code until the fault condition clears and the reset button is pressed. If the fault clears but the reset button has not been pressed, the MotorSaver[®] will continue flashing the fault. If power is lost before the MotorSaver[®] is reset, it will remember the previous fault and continue to flash the corresponding fault code once power is reapplied. This allows for identification of the last fault even after power conditions have returned to normal. As soon as the reset button is pressed, the MotorSaver[®] will resume normal operation.





NOTE: If the jumper is left in place, or the manual reset button is pressed when the 460-MR is powered-up, it will operate in automatic reset mode. If an automatic restart would be a hazard to equipment or personnel, use the manual reset mode.

POWER-UP





Automatic Reset Mode: With the jumper in place, or the manual reset button pressed, apply 3-phase power to the motor. The MotorSaver's green RUN light will blink during the RESTART delay. After the RESTART delay, the MotorSaver[®] will energize its output contacts and the green RUN light will illuminate. If the contacts do not energize and the RUN light does not illuminate, see the TROUBLESHOOTING section.

Manual Reset Mode: With the jumper removed and the manual reset button released, apply 3-phase power to the motor. The MotorSaver's green and red lights will blink in unison until the manual reset button is pressed – then the contacts will energize and the RUN light will illuminate.

NOTE: Upon power up, if a light pattern other than the red and green lights blinking in unison is displayed (while in manual reset mode), the Model 460-MR is in a fault condition or was in a fault condition before it lost power. The fault code will be displayed until the unit is manually reset.

DIAGNOSTIC INDICATOR LIGHTS	
RUN	GREEN
RESTART DELAY	 GREEN
REVERSE PHASE	 RED
UNBALANCE / SINGLE PHASE	 RED
HIGH / LOW VOLTAGE	RED
MANUAL RESET REQUIRED	 GREEN & RED

TROUBLESHOOTING

SYMPTOM	LIGHT PATTERN	SOLUTION
No lights are on - the unit seems completely dead	N/A	Measure the three line-to-line voltages. If any of the voltages are below 150VAC, the MotorSaver [®] does not have enough power to operate its internal electronics. If the voltages are correct, call SymCom at (800) 843-8848 or (605) 348-5580.
Red light is blinking (on initial power-up)	 RED	Turn off the 3-phase power. Swap any two leads powering the MotorSaver [®] (L1, L2, or L3) There is a 50-50 chance of connecting L1, L2 and L3 correctly the first time. Reapply 3-phase power.
Red light is blinking (after the motor has previously been running)	 RED	The incoming lines have been reverse-phased. The MotorSaver [®] is preventing the motor from running backwards. Correct the phase sequence.
Red light is blinking in this pattern	 RED	The voltage is unbalanced or single-phased. Measure the incoming line voltages and calculate the % unbalance. If the voltage unbalance does not exceed the % unbalance reset value, call SymCom at (800) 843-8848 or (605) 348-5580.
Red light is on steady	RED	The voltage is out of tolerance. Measure the three line-to-line voltages. Calculate the average of the three voltages. If the average is 7% above or below the nominal voltage as selected by the LINE VOLTAGE ADJUST, the MotorSaver [®] is functioning properly. If the voltage is within $\pm 7\%$ of the selected line voltage, call SymCom at (800) 843-8848 or (605) 348-5580.
Green light blinks and motor is not running	 GREEN	The MotorSaver [®] is timing through the restart delay – this occurs only when the manual reset jumper is in place.
Green light is on steady, but motor does not start	GREEN	The MotorSaver [®] is in run mode. Ensure other control devices are allowing the motor to start. Check control circuit for loose wires or malfunctioning switches.
Green and red lights blink in unison and motor does not run	 GREEN & RED	The MotorSaver [®] is waiting for a manual reset.

MOTORSAVER® 460-MR SPECIFICATIONS

3-Phase Line Voltage	190-480VAC
	475-600VAC (optional)
	95-120VAC (optional)
Frequency	50*/60Hz
Low Voltage (% of setpoint)	
Trip	90% ±1%
Reset	93% ±1%
High Voltage (% of setpoint)	
Trip	110% ±1%
Reset	107% ±1%
Voltage Unbalance (NEMA)	
Trip	2-8% adjustable
Reset	Trip setting minus 1% (5-8%) Trip setting minus 0.5% (2-4%)
Trip Delay Time (automatic restart mode only)	
Low, High and unbalanced voltage	1-30 seconds adjustable
Single-phasing faults (>25% UB)	1 second fixed
Restart Delay Time	
After a fault or power loss	1-500 seconds adjustable
Output Contact Rating – SPDT	
Pilot Duty	480VA @ 240VAC
General Purpose	10A @ 240VAC
Power Consumption	6 Watts
Weight	14 oz.
Enclosure	Polycarbonate
Terminal	
Torque	6 in.-lbs.
Wire AWG	12-20 AWG
Safety Marks	
UL	UL508 (File #E68520)
CE	IEC 60947-6-2
Standards Passed	
Electrostatic Discharge (ESD)	IEC 100-4-2, Level 3, 6kV contact, 8kV air
Radio Frequency Immunity, Radiated	159 MHz, 10V/m
Fast Transient Burst	IEC 1000-4-4, Level 3, 3.5kV input power and controls
Surge	
IEC	IEC 1000-4-5, Level 3, 4kV line-to-line; Level 4, 4kV line-to-ground
ANSI/IEEE	C62.41 Surge and Ring Wave Compliance to a level of 6kV line-to-line
Hi-Potential Test	Meets UL508 (2 x rated V +1000 V for 1 minute)
Environmental	
Temperature Range	Ambient Operating: -20° to 70°C (-4° to 158°F)
Class of Protection	IP20, NEMA 1 (Finger Safe)
Relative Humidity	10-95%, non-condensing per IEC 68-2-3

*NOTE: 50Hz will increase all delay timers by 20%

DIMENSIONS

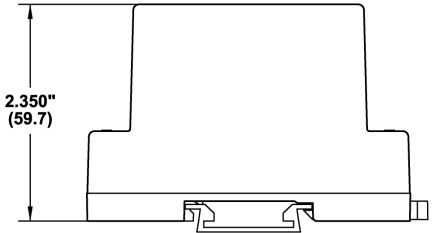
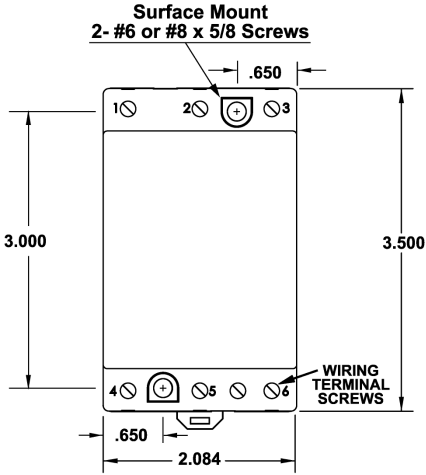

SymCom, Inc. warrants its microcontroller-based products against defects in material or workmanship for a period of five (5) years from the date of manufacture. All other products manufactured by SymCom shall be warranted against defects in material or workmanship for a period of two (2) years from the date of manufacture. For complete information on warranty, liability, terms, and conditions, please refer to the SymCom Terms and Conditions of Sale document.

Visit our website at www.symcom.com for our complete catalog and product listings!



www.SymCom.com

... your electronic control & protection specialists

222 Disk Drive, Rapid City, SD 57701
(800) 843-8848 www.symcom.com