

B57 Series Regulator

Residential Regulator

The B57 regulator is ideally suited for use where inches of water column or pounds delivery pressure are desired for uses including utility services, small boilers, and other similar applications. The B57 is ideal for situations where rapid response is required, such as on/off loads, and can be utilized to avoid shock problems. In situations where complete 360° rotation of the diaphragm case is desired, the B57 can accommodate any position needed.

DESCRIPTION

- » B57R
 - The B57R is a spring-loaded, self operated regulator with an internal relief (designated by the letter “R”) valve. The 1” or optional ¾” internal relief valve provides excellent relief capacity.
- » B57N
 - The B57N is the same as the B57R (above) with the exception that it does not have an internal relief (designated by the letter “N”) valve. This model may be used in situations where an internal relief or other type of over-pressure protection is not required.

OPTION DESIGNATIONS

- » R Internal Relief
- » N No Internal Relief
- » HP All models for outlet pressures above 0.5 PSIG

BENEFITS

- » Light weight
- » Easy to install
- » Smooth control over widely varying inlet pressures
- » No special tools required for outlet pressure adjustment

FEATURES

- » Field interchangeable orifice
- » Field interchangeable adjustment spring
- » 27 sq. in. diaphragm area
- » Spring-loaded internal relief valve assembly
- » Wide range of NPT valve body sizes
- » Primary and secondary informational badges (4 lines available with 24 characters per line)
- » Serial numbers available upon request

SHIPPING WEIGHT

8 Regulators per box Box weight: 52 lbs.

B57 DIMENSIONS (INCHES)

Valve Body	A	B	C	D	E	F	G	R
3/4" & 1"	3-13/16	1-21/32	6	7-5/16	3-5/16	5-3/16	10-5/32	1-1/2
1-1/4"	4	1-7/8	6	7-5/16	3-5/16	5-3/16	10-5/32	1-1/2

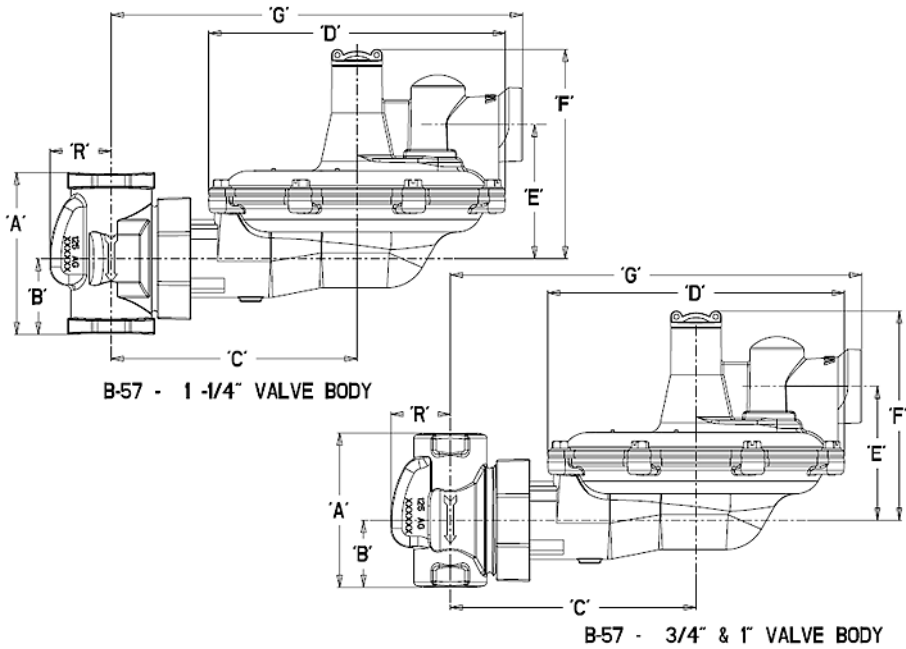

OPERATIONAL SCHEMATIC

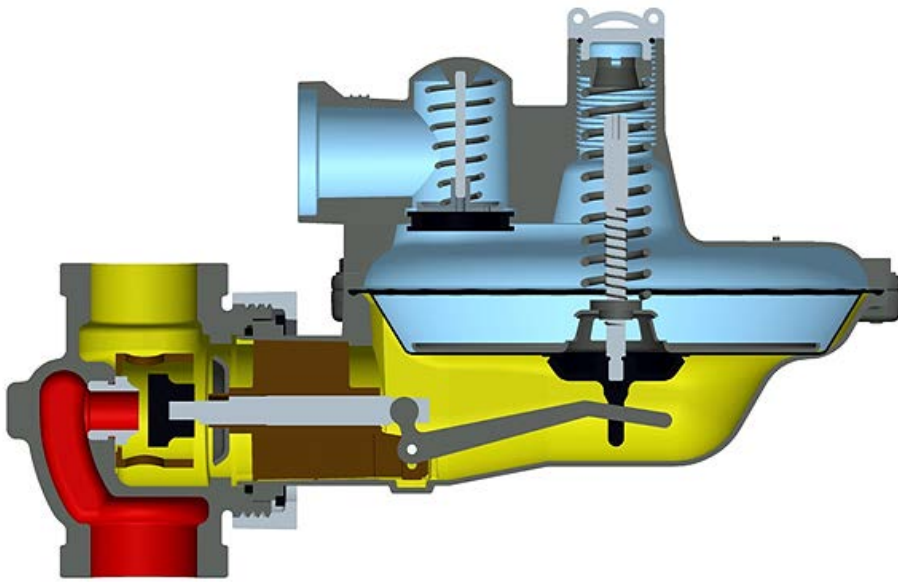

- Inlet Pressure
- Outlet Pressure
- Atmospheric Pressure

SPRING DATA, SPRING COLOR OUTLET PRESSURE RANGE*

Model: B57	Inches w.c.
Brown	4.5 to 5.5
Dark Green	5.0 to 6.5
Gray	6.5 to 9.5
Light Green	5.5 to 8.0
Black	7.3 to 11.0
Blue	8.0 to 12.0
Silver	11.0 to 16.0
Model: B57HP**	PSIG
Red/Gray	0.75 to 1.1
Yellow	0.9 to 1.4
Red	1.3 to 2.0
White	1.75 to 2.5
Relief Spring Data	
Black	7" w.c. above set point

*Spring ranges are approximate and may vary by application.

**Warning: Springs are not interchangeable between B57 and B57HP.

ORIFICE DATA, WIDE OPEN FLOW COEFFICIENTS AND MAXIMUM PRESSURE DATA

Orifice Size	K - Factors	Maximum Operating Inlet Pressure R Models		Max Emergency Inlet Pressure	Max Emergency Outlet Pressure (Containment)	
		Inches w.c. Delivery	PSIG Delivery	All Outlet	Inches w.c. Delivery	PSIG Delivery
		Pressure PSIG	Pressure PSIG	Inlet Pressure PSIG		
1/8"	35	125	175	300	18 PSIG	60 PSIG
0.144" x 3/16"	50	125	175	300		
3/16"	75	125	175	300		
3/16" x 1/4"	75	125	125	300		
1/4"	145	125	125	300		
1/4" x 5/16"	145	100	100	150		
5/16"	235	100	100	150		
3/8"	325	65	60	150		
1/2"	500	40	40	100		
1/2" x 9/16"	500	40	40	100		

Note N model regulators cannot be used without additional safety equipment above 60 PSIG inlet pressures.

OPERATING TEMPERATURE RANGE

- -20°F to 150°F.
- Silicone valve seats available below -20°F.

CONSTRUCTION

Itron takes pride in delivering products with the utmost concern for safety, quality, and customer satisfaction.

Construction material

Valve Body:	High tensile strength cast iron (ASTM A-126, Class A)
Orifice:	Aluminum
Valve Seat:	Buna-N
Valve Stem:	Nylon
Lever Pin:	Stainless steel (Type 303)
Lever:	Zinc and dichromate plated steel (AISI C1010)
Upper Diaphragm Plate:	Zinc and dichromate plated steel (14 gauge steel)
Lower Diaphragm Plate:	Die cast aluminum (ASTM B-85 Alloy SC84A)
Diaphragm:	Buna-N and reinforcing fiber
Vent Valve/Seat:	Neoprene
Vent Screen:	Stainless Steel (16 mesh)
Adjustment Ferrule:	Acetal; die cast aluminum for HP model (ASTM CS43A)
Seal Cap:	ABS Plastic
Diaphragm Case:	Die cast aluminum (ASTM B85 - Alloy SC84A)
Valve Stem Insert:	Acetal

VALVE BODY SIZES

Inlet	Outlet	Straight
1/2"	1/2"	x
3/4"	3/4"	x
3/4"	1"	x
3/4"	1-1/4"	x
1"	1"	x
1"	1-1/4"	x
1-1/4"	1-1/4"	x

X indicates the valve body is available in that configuration.

CORRECTION FACTORS FOR NON-NATURAL GAS APPLICATIONS

The B57 may be used to control gases other than natural gas. To determine the capacity for gases other than natural gas, multiply the values within the capacity tables by a correction factor. The table below lists the correction factors for some of the more common gases:

Gas Type	Specific Gravity	Correction Factor (CF)
Air	1.00	0.77
Butane	2.01	0.55
Carbon Dioxide (Dry)	1.52	0.63
Carbon Monoxide (Dry)	0.97	0.79
Natural Gas	0.60	1.00
Nitrogen	0.97	0.79
Propane	1.53	0.63
Propane-Air-Mix	1.20	0.71

To calculate the correction factor for gases not listed in the table above, use the gases' specific gravity and insert it in the formula listed below:

$$\text{Correction Factor (CF)} = \sqrt{\frac{SG_1}{SG_2}}$$

Where:

SG_1 = Specific gravity of the gas in which the capacity is published.

SG_2 = Specific gravity of the gas to be controlled.

Wide Open Flow Calculations

For wide-open orifice flow calculations use the following equations:

$$\text{For } \frac{P_1}{P_2} < 1.89 \text{ use: } Q = K\sqrt{P_2(P_1 - P_2)}$$

$$\text{For } \frac{P_1}{P_2} > 1.89 \text{ use: } Q = \frac{KP_1}{2}$$

Where: P_1 = Absolute Inlet Pressure (PSIA)

P_2 = Absolute Outlet Pressure (PSIA)

Q = Flow Rate (SCFH)

K = Orifice Coefficient (SCFH/PSI)

B57 SERIES RESIDENTIAL REGULATOR, MODELS N AND R

7" w.c. Capacity Table (1" Droop*) 3/4" x 3/4" Valve Body

Capacities in SCFH of 0.6 S.G. gas; base conditions of 14.7 PSIA and 60° F.

Typical Capacity Info.	
Manufacturer	Itron
Type and model	B57R
Regulator	
Inlet size	3/4"
Outlet size	3/4"
Spring color	Light green
Position	5

Inlet Pressure PSIG	Orifice Size									
	1/8"	0.144" x 3/16"	3/16"	3/16" x 1/4"	1/4"	1/4" x 5/16"	5/16"	3/8"	1/2"	1/2" x 9/16"
8" w.c.				45	55	75	85	100	115	120
10" w.c.				70	80	90	100	115	140	220
12" w.c.		50	65	80	85	100	120	175	240	290
14" w.c.		60	70	85	90	130	145	235	255	310
16" w.c.		70	80	115	130	190	210	250	315	345
21" w.c.		80	90	130	180	220	250	300	370	400
24" w.c.	50	90	110	205	210	250	280	320	410	420
1	60	100	125	245	250	300	310	350	420	440
2	80	270	280	320	350	415	425	450	510	535
3	190	290	320	400	420	440	460	500	570	580
5	265	400	410	485	500	550	600	610	640	645
10	350	515	530	620	640	650	685	700	705	
20	520	650	675	740	755	770	790	820		
30	600	735	750	760	775	775	820	820		
40	630	750	775	800						
50	690	775	790	820						
60	715	790	820	820						
70	740	800	825	825						
80	765	790	825	825						
90	790	830	830	830						
100	815	815	835	835						
120	835	840	840	840						
125	850	855	860	875						

Inlet Effect (Inches w.c.) ^B	0.5	0.5	0.5	0.5	0.5	0.6	0.6	0.6	0.7	0.8
Lock Up (Inches w.c.) ^C	0.1	0.2	0.2	0.3	0.3	0.3	0.3	0.4	0.7	0.8

Notes:

- A. Capacity in black outline generated with black spring.
- B. Change in outlet pressure for 10 PSIG inlet pressure change.
- C. Outlet pressure increase required for lock up.

*Individual regulator performance may vary from data shown.

 Inlet pressure is too low to achieve desired outlet pressure.

 Do not operate orifice in shaded inlet pressure area.

B57 SERIES RESIDENTIAL REGULATOR, MODELS N AND R

7" w.c. Capacity Table (1" Droop*) 3/4" x 1" and 1" x 1" Valve Bodies

Capacities in SCFH of 0.6 S.G. gas; base conditions of 14.7 PSIA and 60°F.

Typical Capacity Info.

Manufacturer	Itron
Type and model	B57R
Regulator	
Inlet size	3/4-inch
Outlet size	1-inch
Spring color	Light
Position	5

Inlet Pressure PSIG	Orifice Size									
	1/8"	0.144" x 3/16"	3/16"	3/16" x 1/4"	1/4"	1/4" x 5/16"	5/16"	3/8"	1/2"	1/2" x 9/16"
8" w.c.				40	45	60	75	80	180	200
10" w.c.				50	55	65	85	90	200	240
12" w.c.		40	55	60	60	75	90	230	240	270
14" w.c.		50	60	70	75	85	95	260	270	300
16" w.c.		60	70	80	85	90	220	280	300	390
21" w.c.		75	80	170	190	200	265	325	380	440
24" w.c.	40	85	90	190	200	260	285	350	440	500
1	50	90	190	210	260	300	315	410	480	570
2	70	280	290	340	380	450	480	600	680	780
3	120	353	360	450	490	550	575	750	840	850
5	280	420	450	600	690	725	860	1050	1100	1135
10	380	580	750	880	1125	1200	1260	1550	1575	1600
20	580	800	1250	1260	1790	1800	1890	2250	2280	2300
30	750	1040	1640	1620	2190	2230	2250	2500	2500	2500
40	910	1270	2030	1980	2300	2330	2500	2500	2500	2500
50	1080	1490	2380	2250	2500	2500	2500	2500		
60	1240	1700	2500	2500	2500	2500	2500	2500		
70	1420	1940	2500	2500	2500	2500	2500			
80	1570	2150	2500	2500	2500	2500	2500			
90	1725	2360	2500	2500	2500	2500	2500			
100	1890	2500	2500	2500	2500	2500	2500			
120	2255	2500	2500	2500	2500					
125	2380	2500	2500	2500	2500					

Inlet Effect (inches w.c.) ^B	0.4	0.4	0.4	0.4	0.7	0.7	0.7	0.7	0.9	1.0
Lock Up (inches w.c.) ^C	0.1	0.1	0.1	0.2	0.2	0.4	0.4	0.4	0.6	0.8

Notes:

- A. Capacity in black outline generated with brown spring.
- B. Change in outlet pressure for 10 PSIG inlet pressure change.
- C. Outlet pressure increase required for lock up.

*Individual regulator performance may vary from data shown.

 Inlet pressure is too low to achieve desired outlet pressure.

 Do not operate orifice in shaded inlet pressure area.

B57 SERIES RESIDENTIAL REGULATOR, MODELS N AND R

7" w.c. Capacity Table (1" Droop*) 3/4" x 1-1/4", 1" x 1-1/4", and 1-1/4" x 1-1/4" Valve Bodies

Capacities in SCFH of 0.6 S.G. gas; base conditions of 14.7 PSIA and 60°F.

Typical Capacity Info.		Orifice Size									
		1/8"	0.144" x 3/16"	3/16"	3/16" x 1/4"	1/4"	1/4" x 5/16"	5/16"	3/8"	1/2"	1/2" x 9/16"
Manufacturer	Itron	8" w.c.			40	65	75	80	95	145	270
Type and model	B57R	10" w.c.			60	75	95	100	190	240	350
Regulator		12" w.c.		40	55	75	90	190	200	250	370
Inlet size	1 1/4-inch	14" w.c.		50	60	95	180	240	300	325	420
Outlet size	1 1/4-inch	16" w.c.		60	70	180	190	290	310	350	490
Spring color	Light Green	21" w.c.		75	80	210	265	340	390	425	580
Position	5	24" w.c.	40	85	95	220	290	370	420	480	640
		1	50	110	240	300	380	400	425	510	720
		2	95	270	320	425	480	625	690	770	1150
		3	180	350	410	525	660	820	870	1025	1410
		5	260	440	560	690	910	1100	1280	1500	1870
		10	380	570	860	890	1440	1570	2180	2260	2340
		20	560	800	1260	1260	2150	2210	2500	2500	2500
		30	740	1025	1625	1620	2500	2500	2500	2500	2500
		40	910	1270	1990	2010	2500	2500	2500	2500	2500
		50	1090	1500	2250	2290	2500	2500	2500	2500	
		60	1240	1710	2500	2500	2500	2500	2500	2500	
		70	1420	1955	2500	2500	2500	2500	2500		
		80	1580	2195	2500	2500	2500	2500	2500		
		90	1725	2360	2500	2500	2500	2500	2500		
		100	1890	2500	2500	2500	2500	2500	2500		
		120	2255	2500	2500	2500	2500				
		125	2380	2500	2500	2500	2500				

Inlet Effect (inches w.c.) ^B	0.2	0.3	0.4	0.5	0.5	0.5	0.7	0.8	1.1	1.1
Lock Up (inches w.c.) ^C	0.1	0.2	0.2	0.2	0.2	0.3	0.4	0.4	0.6	0.8

Notes:

- A. Capacity in black outline generated with black spring.
- B. Capacity in black outline generated with black spring.
- C. Change in outlet pressure for 10 PSIG inlet pressure change.
- D. Outlet pressure increase required for lock up.

*Individual regulator performance may vary from data shown.

 Inlet pressure is too low to achieve desired outlet pressure.

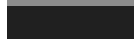
 Do not operate orifice in shaded inlet pressure area.

B57 RELIEF CURVES

7" w.c. Set Point

Manufacturer	Itron
Type and Model	B57R
Regulator	
Inlet Size	3/4"
Outlet Size	1"
Spring Color	Light green
Vent Size	3/4"
Position	5

Set point 7.0" w.c. with 40 PSIG inlet @ 50 SCFH. All test results are reported at a base of 14.7 PSIA and 60°F.

Lever Disconnect 3/4" vent with screen

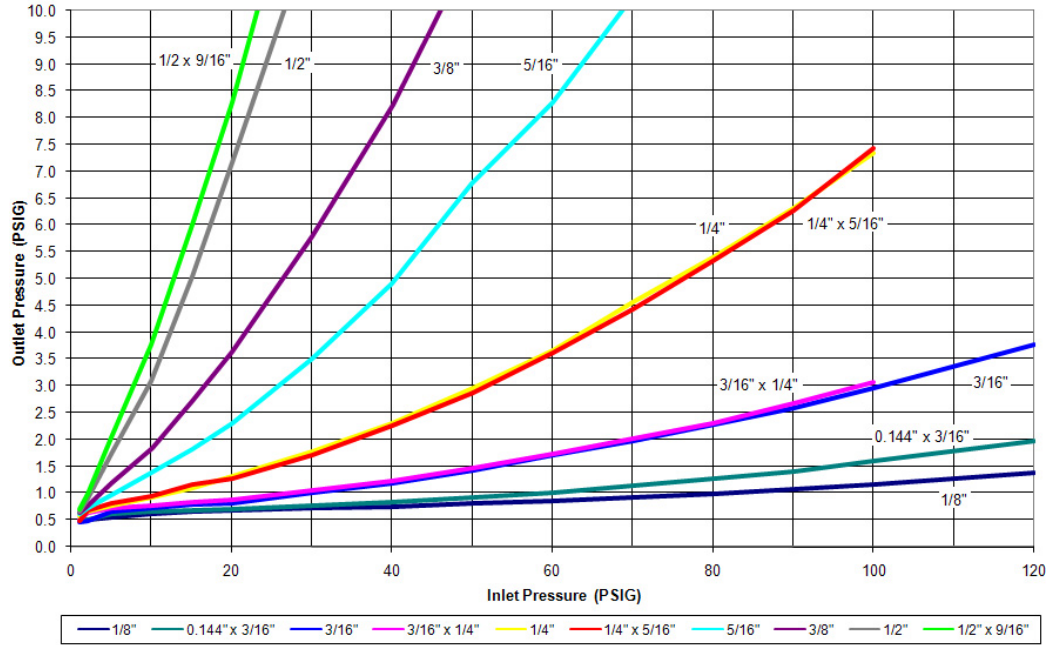

B57 RELIEF CURVES

7" w.c. set point

Manufacturer	Itron
Type and Model	B57R
Regulator	
Inlet Size	3/4"
Outlet Size	1"
Spring Color	Light Green
Vent Size	1"
Position	5

Set point 7.0" w.c. with 40 PSIG inlet @ 50 SCFH. All test results are reported at a base of 14.7 PSIA and 60°F.

Lever Disconnect 1" vent with screen

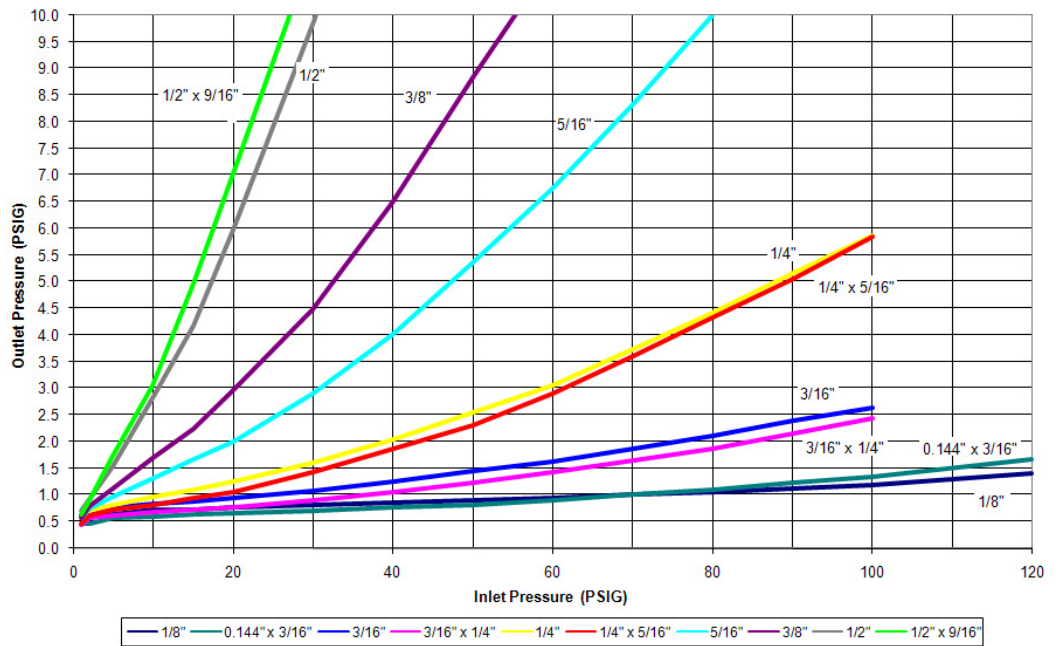

B57 RELIEF CURVES

7" w.c. Set Point

Manufacturer	Itron
Type and Model	B57R
Regulator	
Inlet Size	3/4"
Outlet Size	1"
Spring Color	Light Green
Vent Size	3/4"
Position	5

Set point 7.0" w.c. with 40 PSIG inlet @ 50 SCFH. All test results are reported at a base of 14.7 PSIA and 60°F.

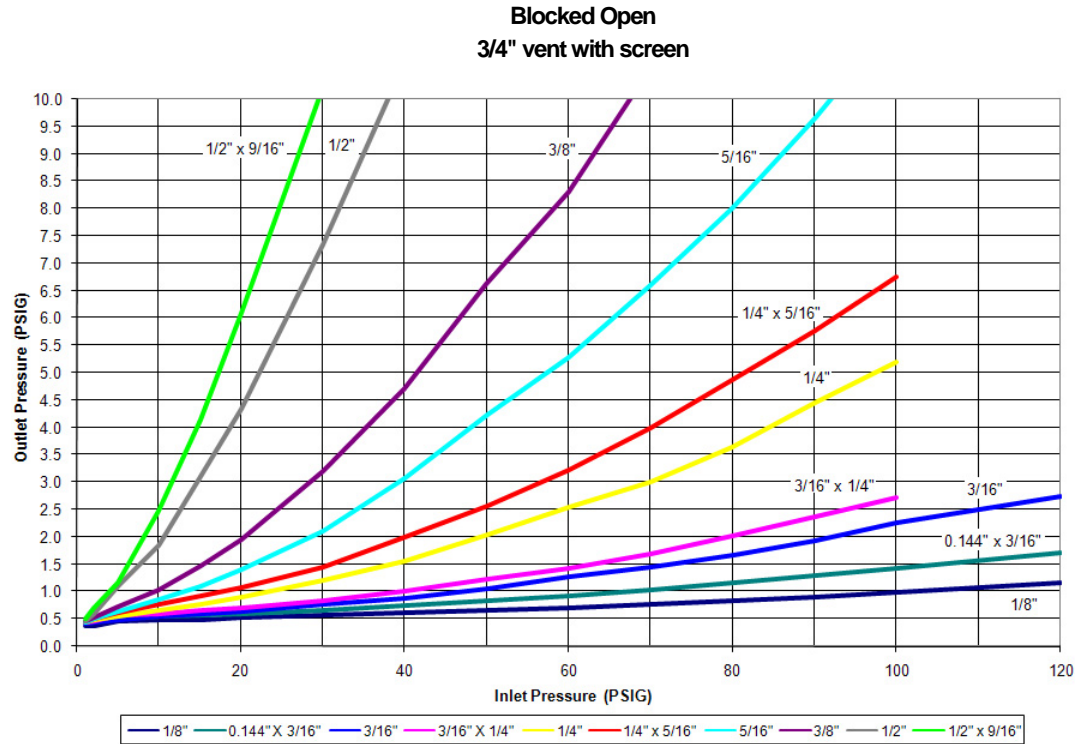

B57 RELIEF CURVES

7" w.c. Set Point

Manufacturer	Itron
Type and Model	B57R
Regulator	
Inlet Size	3/4"
Outlet Size	1"
Spring Color	Light Green
Vent Size	1"
Position	5

Set point 7.0" w.c. with 40 PSIG inlet @ 50 SCFH. All test results are reported at a base of 14.7 PSIA and 60°F.

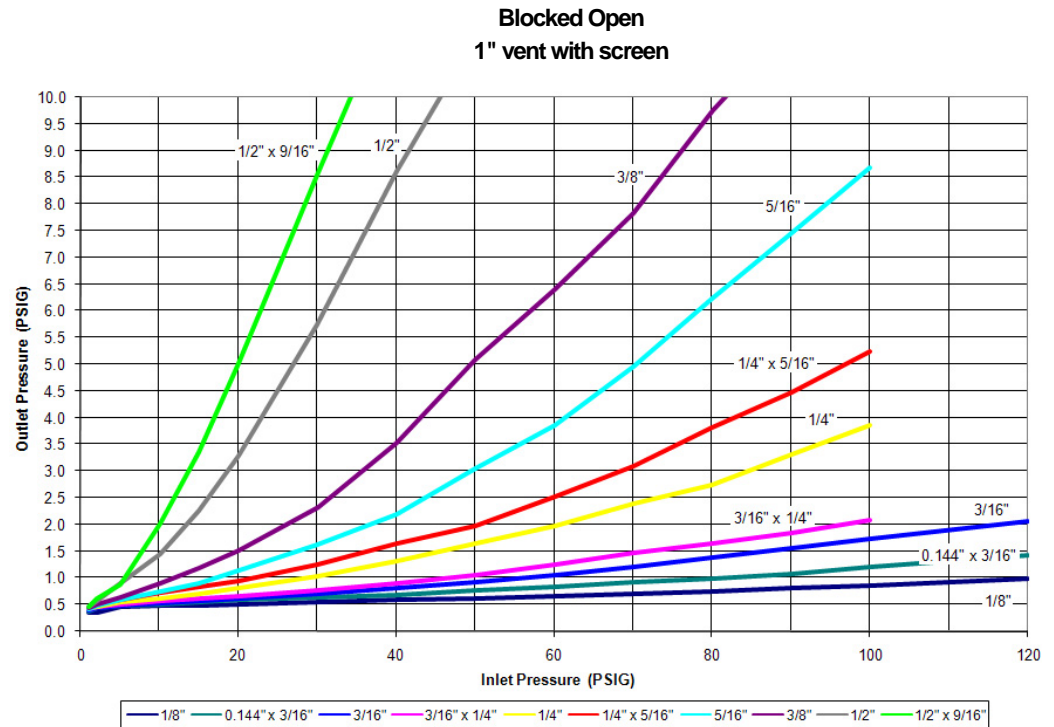

B57R PERFORMANCE CURVES

7" w.c. Set Point

Manufacturer	Itron
Type and Model	B57R
Regulator	
Inlet Size	3/4"
Outlet Size	1"
Spring Color	Light Green
Orifice Size	3/16"

Set point 7.0" w.c. with 40 PSIG inlet @ 50 SCFH. All test results are reported at a base of 14.7 PSIA and 60°F.

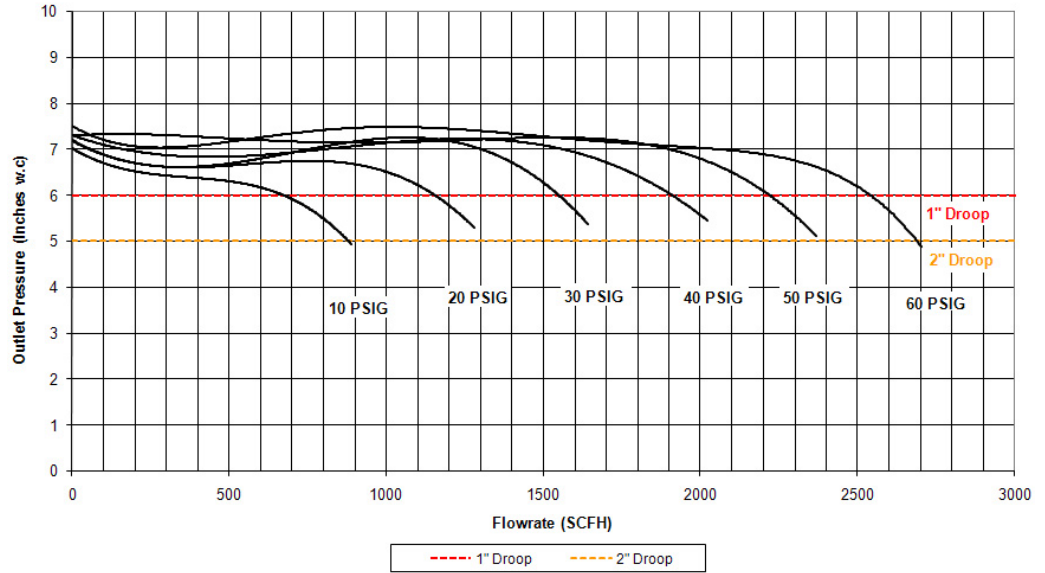

B57 SERIES RESIDENTIAL REGULATOR, MODELS N AND R

14" w.c. Capacity Table (2" Droop*) 3/4" x 3/4" Valve Body

Capacities in SCFH of 0.6 S.G. gas; base conditions of 14.7 PSIA and 60° F.

Typical Capacity Info.	
Manufacturer	Itron
Type and model	B57R
Regulator	
Inlet size	3/4"
Outlet size	3/4"
Spring color	Silver
Position	5

Inlet Pressure PSIG	Orifice Size									
	1/8"	0.144" x 3/16"	3/16"	3/16" x 1/4"	1/4"	1/4" x 5/16"	5/16"	3/8"	1/2"	1/2" x 9/16"
16" w.c.		60	75	85	100	110	110	180	225	245
21" w.c.		75	85	100	115	185	200	225	285	300
24" w.c.	55	90	95	120	130	210	230	250	315	360
1	60	100	105	175	225	245	265	270	370	485
2	80	210	220	280	300	335	350	375	485	545
3	185	230	275	340	355	400	420	450	600	635
5	230	310	325	425	475	515	535	560	780	875
10	320	450	480	585	605	690	740	785	950	1190
20	485	660	720	795	810	900	985	1000	1040	1380
30	645	810	870	930	940	950	1055	1070	1070	1400
40	735	945	970	1075	1075	1075	1130	1140	1140	1440
50	850	1015	1035	1100	1100	1100	1150	1175		
60	925	1050	1100	1110	1110	1110	1160	1230		
70	960	1070	1110	1140	1160					
80	1000	1080	1130	1140	1180					
90	1025	1090	1130	1140	1215					
100	1060	1110	1130	1145	1230					
120	1080	1080	1135	1145	1250					
125	1120	1140	1240	1270	1300					

Inlet Effect (inches w.c.) ^A	0.4	0.4	0.4	0.6	0.6	0.7	0.7	0.7	0.8	1.0
Lock Up (inches w.c.) ^B	0.2	0.3	0.3	0.3	0.4	0.4	0.4	0.5	0.9	1.2

Notes:

A. Change in outlet pressure for 10 PSIG inlet pressure change.

B. Outlet pressure increase required for lock up.

*Individual regulator performance may vary from data shown.

 Inlet pressure is too low to achieve desired outlet pressure.

 Do not operate orifice in shaded inlet pressure area.

B57 SERIES RESIDENTIAL REGULATOR, MODELS N AND R

14" w.c. Capacity Table (2" Droop*) 3/4" x 1" and 1" x 1" Valve Body

Capacities in SCFH of 0.6 S.G. gas; base conditions of 14.7 PSIA and 60° F.

Typical Capacity Info.		Orifice Size										
		1/8"	0.144" x 3/16"	3/16"	3/16" x 1/4"	1/4"	1/4" x 5/16"	5/16"	3/8"	1/2"	1/2" x 9/16"	
Manufacturer	Itron	16" w.c.			50	70	80	90	180	190	210	220
Type and model	B57R	21" w.c.		55	60	80	95	120	190	250	280	340
Regulator		24" w.c.		60	70	90	190	240	250	280	320	400
Inlet size	3/4"	1		70	80	200	250	270	290	300	400	440
Outlet size	1"	2	65	210	250	350	320	380	400	460	625	710
Spring color	Silver	3	170	280	320	410	425	520	540	625	800	920
Position	5	5	260	380	410	550	560	720	740	900	1120	1270
		10	340	550	620	820	840	1180	1190	1420	1610	1725
		20	550	800	1120	1280	1300	1810	1880	2120	2140	2150
		30	740	1040	1560	1650	1700	2190	2200	2500	2500	2500
		40	920	1260	1650	2010	2125	2500	2500	2500	2500	2500
		50	1080	1490	2265	2365	2380	2500	2500	2500		
		60	1250	1710	2500	2500	2500	2500	2500	2500		
		70	1420	1950	2500	2500	2500	2500	2500			
		80	1575	2160	2500	2500	2500	2500	2500			
		90	1725	2360	2500	2500	2500	2500	2500			
		100	1900	2500	2500	2500	2500	2500	2500			
		120	2245	2500	2500	2500	2500					
		125	2370	2500	2500	2500	2500					

Inlet Effect (inches w.c.) ^A	0.6	0.6	0.7	0.7	0.7	0.7	1.0	1.0	1.3	1.3
Lock Up (inches w.c.) ^B	0.2	0.3	0.4	0.4	0.4	0.4	0.4	0.5	0.7	0.8

Notes:

A. Change in outlet pressure for 10 PSIG inlet pressure change.

B. Outlet pressure increase required for lock up.

*Individual regulator performance may vary from data shown.

 Inlet pressure is too low to achieve desired outlet pressure.

 Do not operate orifice in shaded inlet pressure area.

 Capacity in black outline generated with Blue Spring.

B57 SERIES RESIDENTIAL REGULATOR, MODELS N AND R

14" w.c. Capacity Table (2" Droop*) 3/4" x 1-1/4", 1" x 1-1/4", and 1-1/4" x 1-1/4" Valve Body

Capacities in SCFH of 0.6 S.G. gas; base conditions of 14.7 PSIA and 60° F.

Typical Capacity Info.	Inlet Pressure PSIG	Orifice Size									
		1/8"	0.144" x 3/16"	3/16"	3/16" x 1/4"	1/4"	1/4" x 5/16"	5/16"	3/8"	1/2"	1/2" x 9/16"
Manufacturer Itron	16" w.c.			45	75	95	120	145	200	340	410
Type and model B57R	21" w.c.			70	115	125	225	280	290	410	460
Regulator	24" w.c.		65	80	165	190	290	310	350	460	525
Inlet size 1-1/4"	1	40	80	100	200	250	325	390	425	540	640
Outlet size 1-1/4"	2	70	225	310	400	425	540	560	625	870	1000
Spring color Silver	3	100	320	380	500	550	690	720	820	1090	1260
Position 5	5	240	420	525	660	770	950	1025	1080	1400	1570
	10	380	560	820	890	1240	1410	1620	1630	1880	2000
	20	560	790	1250	1260	2020	2150	2500	2500	2500	2500
	30	740	1020	1610	1620	2500	2500	2500	2500	2500	2500
	40	910	1250	2000	2010	2500	2500	2500	2500	2500	2500
	50	1080	1480	2265	2360	2500	2500	2500	2500		
	60	1225	1710	2500	2500	2500	2500	2500	2500		
	70	1410	1945	2500	2500	2500	2500	2500			
	80	1580	2170	2500	2500	2500	2500	2500			
	90	1710	2375	2500	2500	2500	2500	2500			
	100	1890	2500	2500	2500	2500	2500	2500			
	120	2215	2500	2500	2500	2500					
	125	2365	2500	2500	2500	2500					

Inlet Effect (inches w.c.) ^A	0.4	0.4	0.4	0.7	0.7	0.7	0.7	0.9	0.9	1.0
Lock Up (inches w.c.) ^B	0.1	0.2	0.3	0.4	0.4	0.4	0.4	0.6	0.7	1.0

Notes:

A. Change in outlet pressure for 10 PSIG inlet pressure change.

B. Outlet pressure increase required for lock up.

*Individual regulator performance may vary from data shown.

 Inlet pressure is too low to achieve desired outlet pressure.

 Do not operate orifice in shaded inlet pressure area.

B57 RELIEF CURVES

14" w.c. Set Point

Manufacturer	Itron
Type and Model	B57R
Regulator	
Inlet Size	3/4"
Outlet Size	1"
Spring Color	Silver
Vent Size	3/4"
Position	5

Set point 7.0" w.c. with 40 PSIG inlet @ 50 SCFH. All test results are reported at a base of 14.7 PSIA and 60°F.

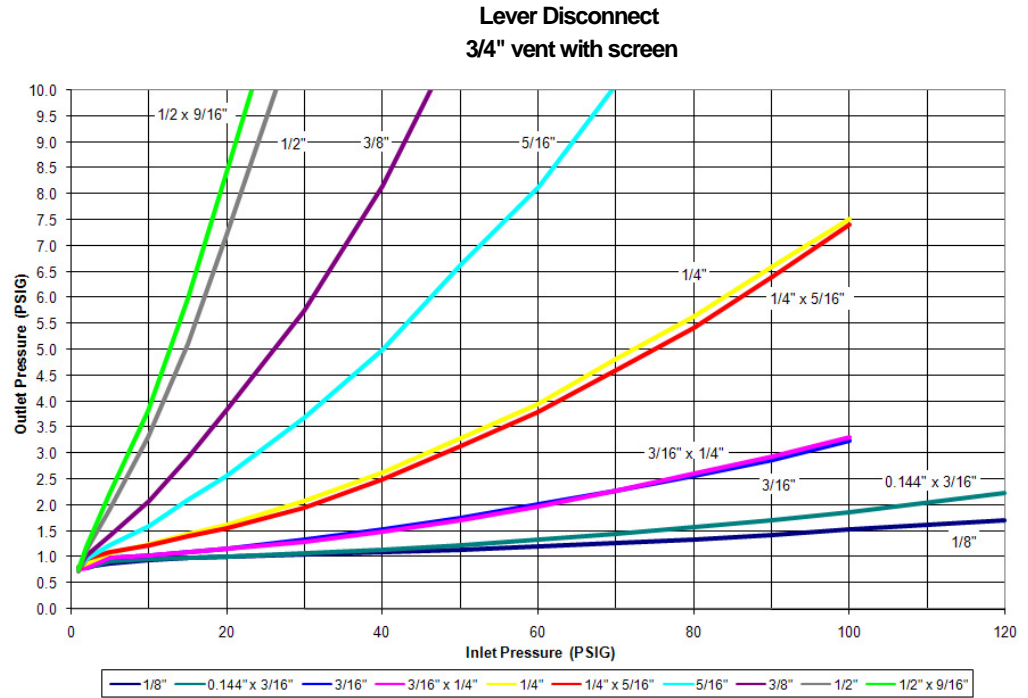

B57 RELIEF CURVES

14" w.c. Set Point

Manufacturer	Itron
Type and Model	B57R
Regulator	
Inlet Size	3/4"
Outlet Size	1"
Spring Color	Silver
Vent Size	1"
Position	5

Set point 7.0" w.c. with 40 PSIG inlet @ 50 SCFH. All test results are reported at a base of 14.7 PSIA and 60°F.

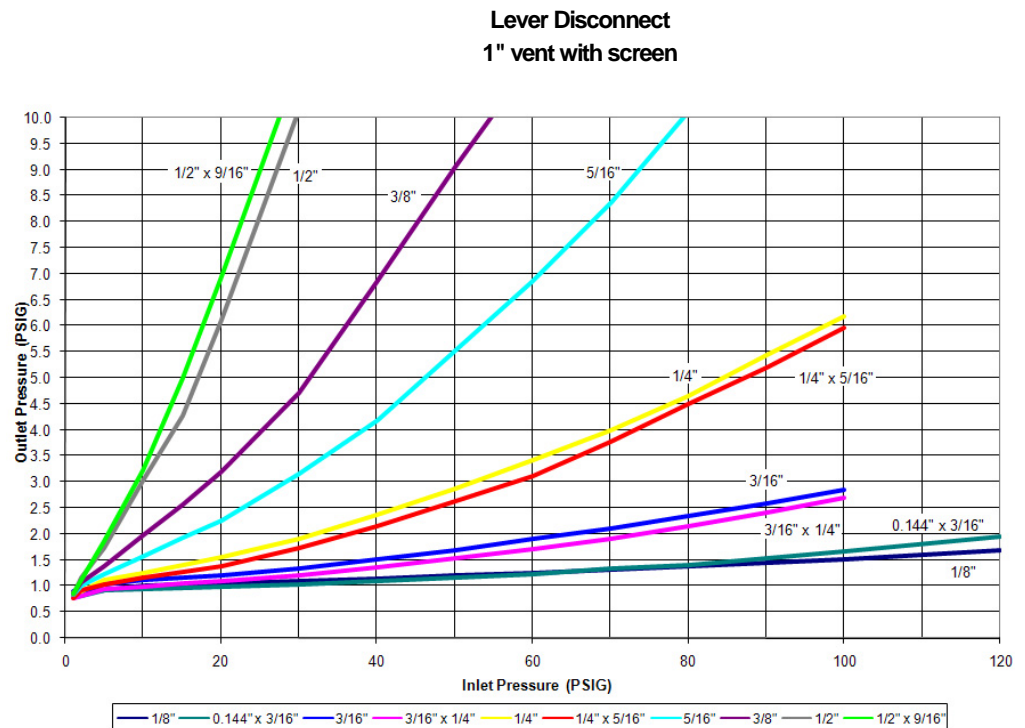

B57 RELIEF CURVES

14" w.c. Set Point

Manufacturer	Itron
Type and Model	B57R
Regulator	
Inlet Size	3/4"
Outlet Size	1"
Spring Color	Silver
Vent Size	3/4"
Position	5

Set point 7.0" w.c. with 40 PSIG inlet @ 50 SCFH. All test results are reported at a base of 14.7 PSIA and 60°F.

Blocked Open
3/4" Vent with screen

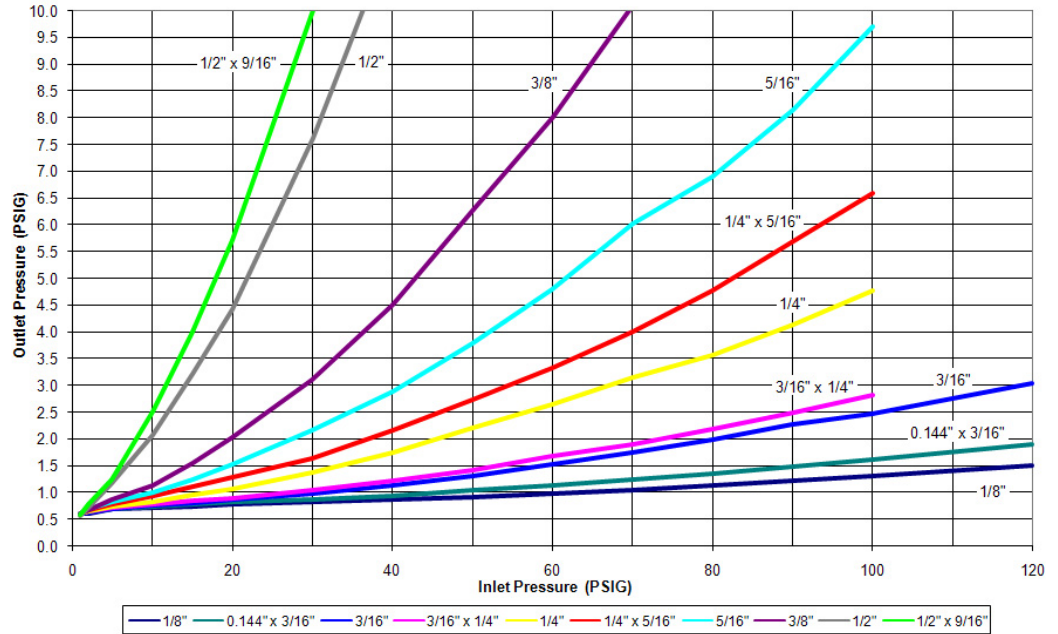

B57 RELIEF CURVES

14" w.c. Set Point

Manufacturer	Itron
Type and Model	B57R
Regulator	
Inlet Size	3/4"
Outlet Size	1"
Spring Color	Silver
Vent Size	1"
Position	5

Set point 7.0" w.c. with 40 PSIG inlet @ 50 SCFH. All test results are reported at a base of 14.7 PSIA and 60°F.

Blocked Open
1" vent with screen

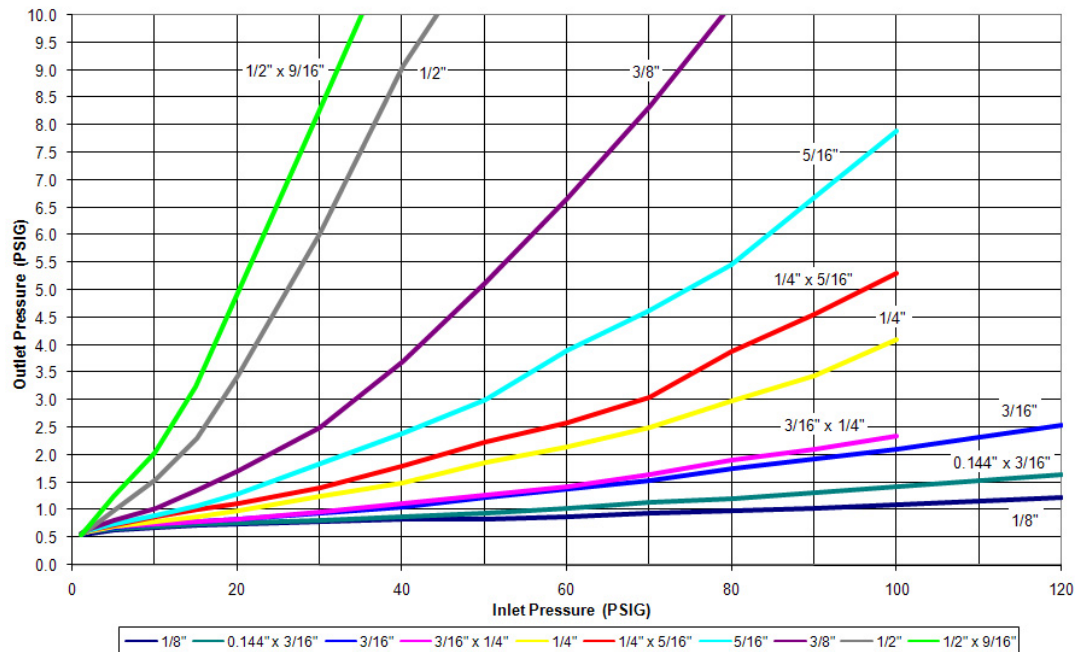

B57R PERFORMANCE CURVES

14" w.c. Set Point

Manufacturer	Itron
Type and Model	B57R
Regulator	
Inlet Size	3/4"
Outlet Size	1"
Spring Color	Silver
Orifice Size	3/16"

Set point 7.0" w.c. with 40 PSIG inlet @ 50 SCFH. All test results are reported at a base of 14.7 PSIA and 60°F.

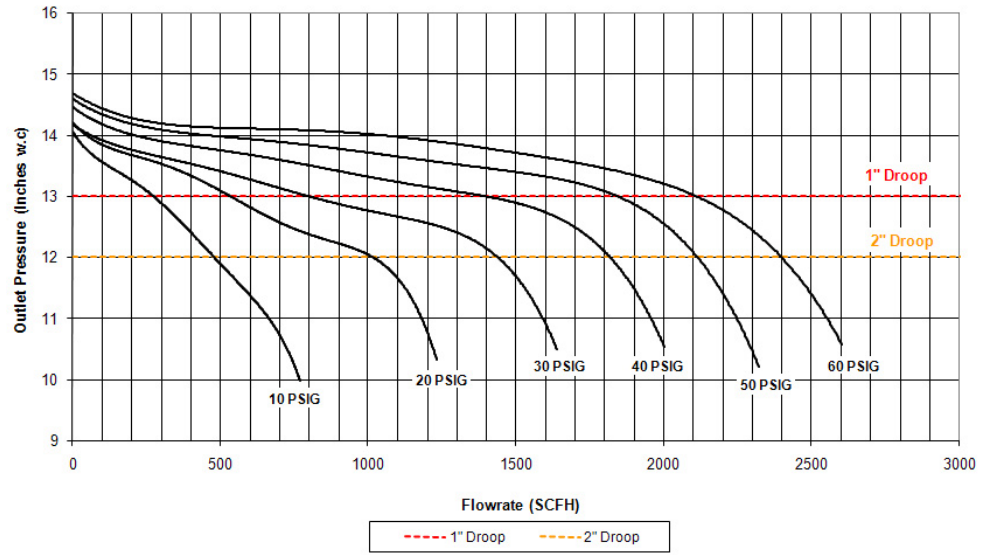

B57 SERIES RESIDENTIAL REGULATOR, MODELS N AND R

1 PSIG Capacity Table (1% Absolute Droop*) 3/4" x 3/4" Valve Body

Capacities in SCFH of 0.6 S.G. gas; base conditions of 14.7 PSIA and 60° F.

Typical Capacity Info.		Orifice Size										
		1/8"	0.144" x 3/16"	3/16"	3/16" x 1/4"	1/4"	1/4" x 5/16"	5/16"	3/8"	1/2"	1/2" x 9/16"	
Manufacturer	Itron	2	75	125	185	220	235	265	290	310	420	460
Type and model	B57RHP	3	100	190	230	305	295	350	370	400	535	640
Regulator		5	195	300	310	390	400	445	480	545	705	800
Inlet size	3/4"	10	290	430	445	600	565	660	675	750	1015	1110
Outlet size	3/4"	20	410	620	640	845	850	945	955	1090	1310	1405
Spring color	Red/Gray	30	545	780	800	900	950	1090	1110	1255	1325	1450
Position	5	40	655	920	940	1090	1120	1210	1235	1320	1345	1550
		50	760	1020	1090	1160	1190	1360	1380	1410		
		60	855	1115	1180	1310	1320	1430	1465	1575		
		70	955	1255	1350	1375	1395	1540	1560			
		80	1060	1280	1370	1400	1410	1560	1570			
		90	1100	1370	1385	1450	1475	1580	1625			
		100	1145	1380	1410	1500	1500	1645				
		120	1200	1400	1475	1510	1510					
		125	1330	1430	1490	1560	1570					

Inlet Effect (PSIG) ^A	0.03	0.04	0.04	0.04	0.05	0.05	0.05	0.05	0.07	0.07
Inlet Effect (PSIG) ^B	0.01	0.02	0.02	0.02	0.02	0.03	0.03	0.04	0.05	0.06

Notes:

A. Change in outlet pressure for 10 PSIG inlet pressure change.

B. Outlet pressure increase required for lock up.

*Individual regulator performance may vary from data shown.

 Do not operate orifice in shaded inlet pressure area.

 Capacity in black outline generated with Yellow Spring.

Capacity Table (2% Absolute Droop*) 3/4" x 3/4" Valve Body

Capacities in SCFH of 0.6 S.G. gas; base conditions of 14.7 PSIA and 60° F.

Typical Capacity Info.		Orifice Size										
		1/8"	0.144" x 3/16"	3/16"	3/16" x 1/4"	1/4"	1/4" x 5/16"	5/16"	3/8"	1/2"	1/2" x 9/16"	
Manufacturer	Itron	2	95	240	280	355	410	450	490	545	725	825
Type and model	B57RHP	3	175	310	360	460	490	590	625	700	900	1050
Regulator		5	260	415	465	610	665	775	830	950	1150	1300
Inlet size	3/4"	10	380	555	710	855	930	1110	1165	1280	1510	1660
Outlet size	3/4"	20	565	775	1055	1240	1315	1485	1590	1720	1880	1990
Spring color	Red/Gray	30	750	1020	1325	1500	1570	1750	1790	1910	2010	2155
Position	5	40	910	1235	1540	1710	1765	1985	2010	2090	2175	2190
		50	1075	1460	1720	1850	1940	2050	2125	2110		
		60	1230	1640	1900	1975	2040	2125	2250	2245		
		70	1420	1775	2010	2060	2100	2200	2300			
		80	1565	1910	2085	2125	2120	2310	2350			
		90	1665	2000	2160	2190	2210	2320	2400			
		100	1815	2030	2180	2215	2220	2385	2415			
		120	1990	2150	2215	2230	2230					
		125	2280	2280	2275	2300	2315					

Inlet Effect (PSIG) ^A	0.03	0.04	0.04	0.04	0.05	0.05	0.05	0.05	0.07	0.07
Lock Up (PSIG) ^B	0.01	0.02	0.02	0.02	0.02	0.03	0.03	0.04	0.05	0.06

Notes:

A. Change in outlet pressure for 10 PSIG inlet pressure change.

B. Outlet pressure increase required for lock up.

*Individual regulator performance may vary from data shown.

 Do not operate orifice in shaded inlet pressure area.

 Capacities in black outline generated with Yellow Spring.

B57 SERIES RESIDENTIAL REGULATOR, MODELS N AND R

1 PSIG Capacity Table (1% Absolute Droop*) 3/4" x 1" and 1" x 1" Valve Body

Capacities in SCFH of 0.6 S.G. gas; base conditions of 14.7 PSIA and 60° F.

Typical Capacity Info.		Orifice Size										
		Inlet Pressure PSIG	1/8"	0.144" x 3/16"	3/16"	3/16" x 1/4"	1/4"	1/4" x 5/16"	5/16"	3/8"	1/2"	1/2" x 9/16"
Manufacturer	Itron	2	75	180	240	250	260	280	300	325	460	520
Type and model	B57RHP	3	95	225	270	300	320	360	380	450	570	680
Regulator		5	200	320	330	400	420	500	520	610	770	860
Inlet size	3/4"	10	300	440	460	620	645	750	790	920	1240	1280
Outlet size	1"	20	440	700	760	1040	1080	1180	1220	1600	1725	1925
Spring color	Red/Gray	30	610	920	1020	1440	1460	1700	1725	2000	2025	2100
Position	5	40	770	1180	1400	1800	1840	2100	2150	2225	2260	2340
		50	920	1410	1625	2140	2160	2270	2310	2500		
		60	1110	1620	1940	2395	2445	2500	2500	2500		
		70	1300	1860	2120	2500	2500	2500	2500			
		80	1435	2070	2300	2500	2500	2500	2500			
		90	1600	2200	2450	2500	2500	2500	2500			
		100	1765	2360	2500	2500	2500	2500	2500			
		120	2120	2400	2500	2500	2500					
		125	2200	2500	2500	2500	2500					

Inlet Effect (PSIG) ^A	0.05	0.05	0.05	0.05	0.05	0.05	0.06	0.06	0.06	0.08	0.08
Inlet Effect (PSIG) ^B	0.01	0.01	0.02	0.02	0.02	0.02	0.03	0.03	0.03	0.05	0.07

Notes:

A. Change in outlet pressure for 10 PSIG inlet pressure change.

B. Outlet pressure increase required for lock up.

*Individual regulator performance may vary from data shown.

 Do not operate orifice in shaded inlet pressure area.

 Capacity in black outline generated with Yellow Spring.

Capacity Table (2% Absolute Droop*) 3/4" x 1" and 1" x 1" Valve Body

Capacities in SCFH of 0.6 S.G. gas; base conditions of 14.7 PSIA and 60° F.

Typical Capacity Info.		Orifice Size										
		1/8"	0.144" x 3/16"	3/16"	3/16" x 1/4"	1/4"	1/4" x 5/16"	5/16"	3/8"	1/2"	1/2" x 9/16"	
Manufacturer	Itron	2	90	240	320	390	420	510	530	600	810	950
Type and model	B57RHP	3	190	325	380	485	520	640	660	790	1020	1190
Regulator		5	260	440	510	650	700	900	925	1080	1350	1580
Inlet size	3/4"	10	390	580	760	910	1090	1340	1410	1625	2000	2185
Outlet size	3/4"	20	570	800	1200	1260	1710	2060	2130	2500	2500	2500
Spring Color	Red/Gray	30	750	1020	160	1620	2280	2500	2500	2500	2500	2500
Position	5	40	920	1260	2000	2010	2500	2500	2500	2500	2500	2500
		50	1090	1490	2300	2320	2500	2500	2500	2500		
		60	1225	1710	2500	2500	2500	2500	2500	2500		
		70	1420	1945	2500	2500	2500	2500	2500			
		80	1570	2160	2500	2500	2500	2500	2500			
		90	1720	2375	2500	2500	2500	2500	2500			
		100	1900	2500	2500	2500	2500	2500	2500			
		120	2225	2500	2500	2500	2500					
		125	2350	2500	2500	2500	2500					

Inlet Effect (PSIG) ^A	0.05	0.05	0.05	0.05	0.05	0.05	0.06	0.06	0.06	0.08	0.08
Lock Up (PSIG) ^B	0.01	0.01	0.02	0.02	0.02	0.02	0.03	0.03	0.03	0.05	0.07

Notes:

A. Change in outlet pressure for 10 PSIG inlet pressure change.

B. Outlet pressure increase required for lock up.

*Individual regulator performance may vary from data shown.

 Do not operate orifice in shaded inlet pressure area.

 Capacities in black outline generated with Yellow Spring.

B57 SERIES RESIDENTIAL REGULATOR, MODELS N AND R

1 PSIG Capacity Table (1% Absolute Droop*) 3/4" x 1-1/4", 1" x 1-1/4" and 1-1/4" x 1-1/4" Valve Body

Capacities in SCFH of 0.6 S.G. gas; base conditions of 14.7 PSIA and 60° F.

Typical Capacity Info.	
Manufacturer	Itron
Type and model	B57RHP
Regulator	
Inlet	1-1/4"
Outlet size	1-1/4"
Spring color	Red/Gray
Position	5

Inlet Pressure PSIG	Orifice Size										
	1/8"	0.144" x 3/16"	3/16"	3/16" x 1/4"	1/4"	1/4" x 5/16"	5/16"	3/8"	1/2"	1/2" x 9/16"	
2	75	120	260	290	325	350	370	460	620	700	
3	180	220	290	390	400	490	500	590	800	950	
5	240	340	400	520	540	690	725	840	1180	1400	
10	350	510	625	840	900	1080	1160	1360	1850	1980	
20	570	720	1080	1250	1425	1710	1850	2040	2500	2500	
30	760	950	1410	1620	1980	2180	2500	2500	2500	2500	
40	960	1170	1870	1990	2400	2500	2500	2500	2500	2500	
50	1140	1410	2210	2300	2500	2500	2500	2500	2500	2500	
60	1290	1640	2500	2500	2500	2500	2500	2500	2500	2500	
70	1490	1895	2500	2500	2500	2500	2500	2500	2500	2500	
80	1675	2135	2500	2500	2500	2500	2500	2500	2500	2500	
90	1820	2340	2500	2500	2500	2500	2500	2500	2500	2500	
100	2000	2500	2500	2500	2500	2500	2500	2500	2500	2500	
120	2335	2500	2500	2500	2500	2500	2500	2500	2500	2500	
125	2490	2500	2500	2500	2500	2500	2500	2500	2500	2500	

Inlet Effect (PSIG) ^A	0.03	0.03	0.03	0.03	0.04	0.04	0.04	0.04	0.05	0.05
Lock Up (PSIG) ^B	0.01	0.01	0.01	0.02	0.02	0.02	0.02	0.03	0.04	0.05

Notes:

A. Change in outlet pressure for 10 PSIG inlet pressure change.

B. Outlet pressure increase required for lock up.

*Individual regulator performance may vary from data shown.

 Do not operate orifice in shaded inlet pressure area.

Capacity Table (2% Absolute Droop*) 3/4" x 1-1/4", 1" x 1-1/4" and 1-1/4" x 1-1/4" Valve Body

Capacities in SCFH of 0.6 S.G. gas; base conditions of 14.7 PSIA and 60° F.

Typical Capacity Info.

Manufacturer	Itron
Type and model	B57RHP
Regulator	
Inlet size	1-1/4"
Outlet size	1-1/4"
Spring color	Red/Gray
Position	5

Inlet Pressure PSIG	Orifice Size										
	1/8"	0.144" x 3/16"	3/16"	3/16" x 1/4"	1/4"	1/4" x 5/16"	5/16"	3/8"	1/2"	1/2" x 9/16"	
2	90	200	310	390	460	600	640	780	1080	1280	
3	190	290	400	500	620	780	850	1010	1400	1680	
5	260	390	550	670	850	1090	1210	1460	1960	2310	
10	400	510	860	890	1360	1560	1840	2220	2500	2500	
20	600	725	1260	1260	2080	2180	2500	2500	2500	2500	
30	780	950	1620	1630	2500	2500	2500	2500	2500	2500	
40	970	1200	1990	2000	2500	2500	2500	2500	2500	2500	
50	1150	1420	2280	2310	2500	2500	2500	2500	2500		
60	1300	1650	2500	2500	2500	2500	2500	2500	2500		
70	1500	1915	2500	2500	2500	2500	2500	2500			
80	1685	2150	2500	2500	2500	2500	2500	2500			
90	1820	2340	2500	2500	2500	2500	2500	2500			
100	2010	2500	2500	2500	2500	2500	2500	2500			
120	2350	2500	2500	2500	2500						
125	2490	2500	2500	2500	2500						

Inlet Effect ^A (PSIG)	0.03	0.03	0.03	0.03	0.04	0.04	0.04	0.04	0.05	0.05
Lock Up ^B (PSIG)	0.01	0.01	0.01	0.02	0.02	0.02	0.02	0.03	0.04	0.05

Notes:

A. Change in outlet pressure for 10 PSIG inlet pressure change.

B. Outlet pressure increase required for lock up.

*Individual regulator performance may vary from data shown.

 Do not operate orifice in shaded inlet pressure area.

B57 RELIEF CURVES

1 PSIG Set Point

Manufacturer	Itron
Type and Model	B57RHP
Regulator	
Inlet Size	3/4"
Outlet Size	1"
Spring Color	Red/Grey
Vent Size	3/4"
Position	5

Set point 7.0" w.c. with 40 PSIG inlet @ 50 SCFH. All test results are reported at a base of 14.7 PSIA and 60°F.

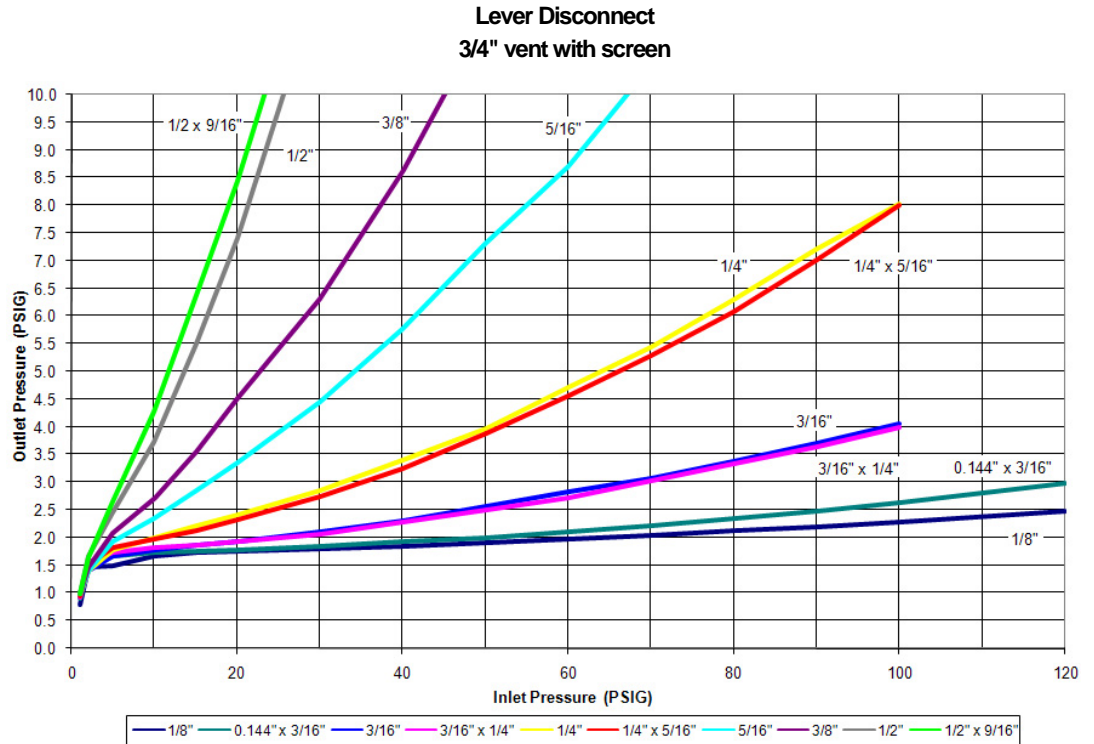

1 PSIG Set Point

Manufacturer	Itron
Type and Model	B57RHP
Regulator	
Inlet Size	3/4"
Outlet Size	1"
Spring Color	Red/Gray
Vent Size	1"
Position	5

Set point 7.0" w.c. with 40 PSIG inlet @ 50 SCFH. All test results are reported at a base of 14.7 PSIA and 60°F.

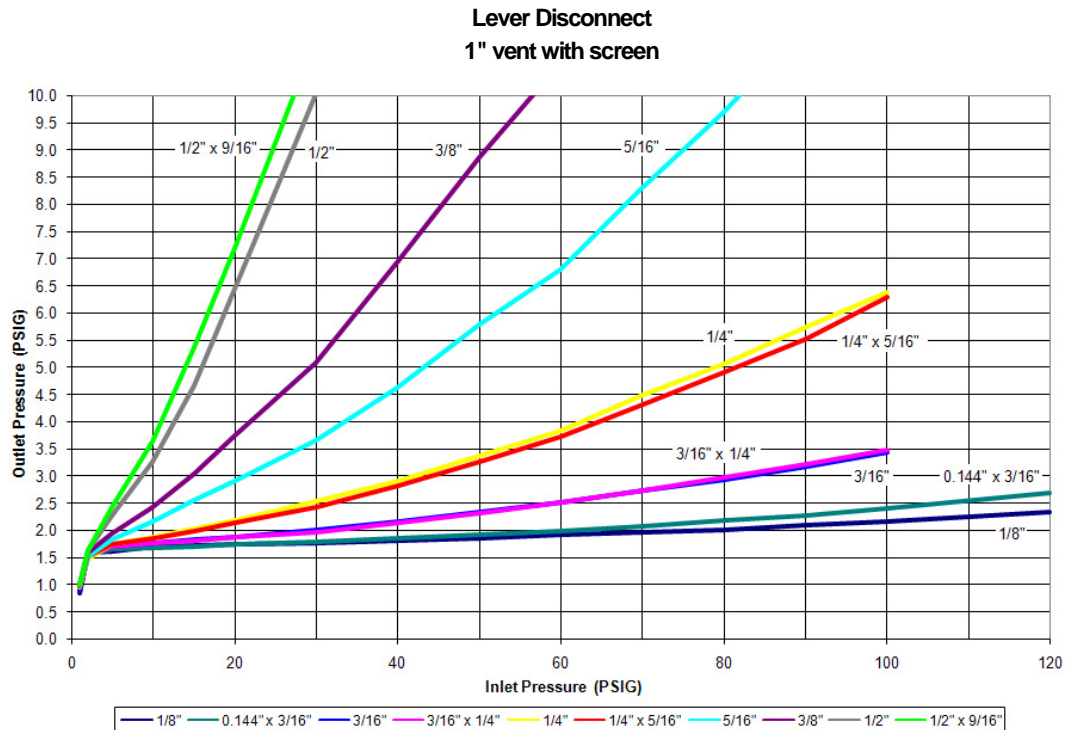

B57 RELIEF CURVES

1 PSIG Set Point

Manufacturer	Itron
Type and Model	B57RHP
Regulator	
Inlet Size	3/4"
Outlet Size	1"
Spring Color	Red/Gray
Vent Size	3/4"
Position	5

Set point 7.0" w.c. with 40 PSIG inlet @ 50 SCFH. All test results are reported at a base of 14.7 PSIA and 60°F.

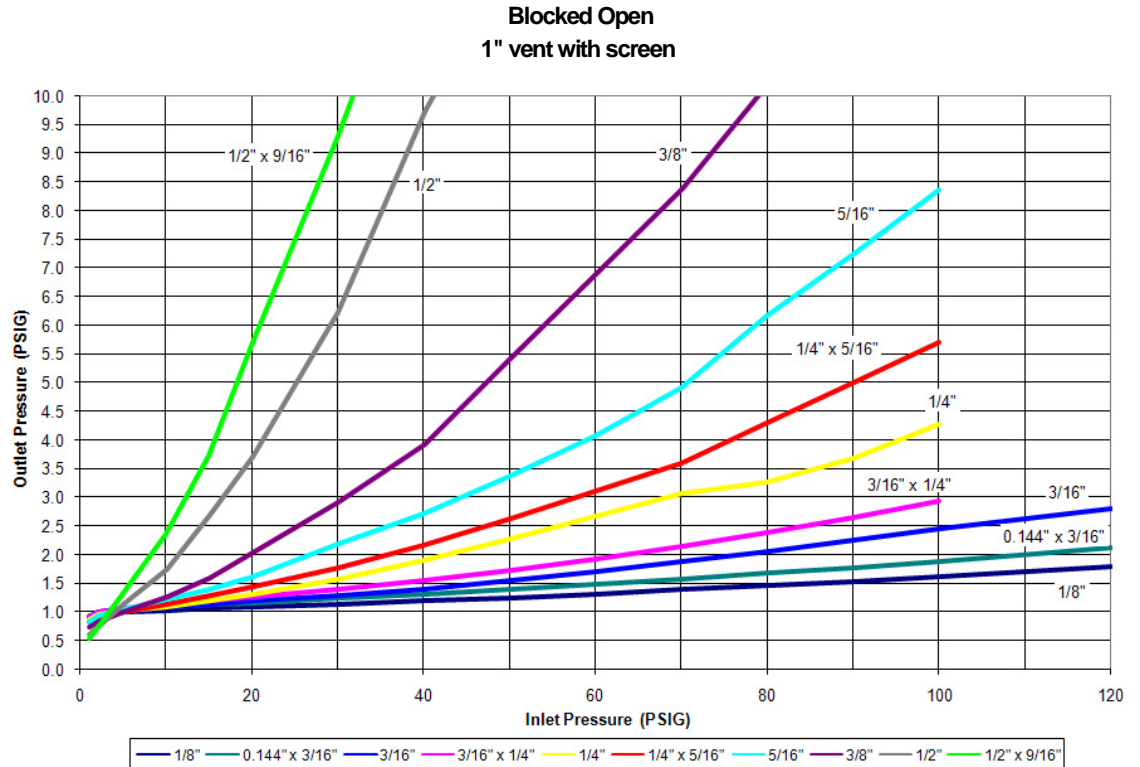

B57 RELIEF CURVES

1 PSIG Set Point

Manufacturer	Itron
Type and Model	B57RHP
Regulator	
Inlet Size	3/4"
Outlet Size	1"
Spring Color	Red/Gray
Vent Size	1"
Position	5

Set point 7.0" w.c. with 40 PSIG inlet @ 50 SCFH. All test results are reported at a base of 14.7 PSIA and 60°F.

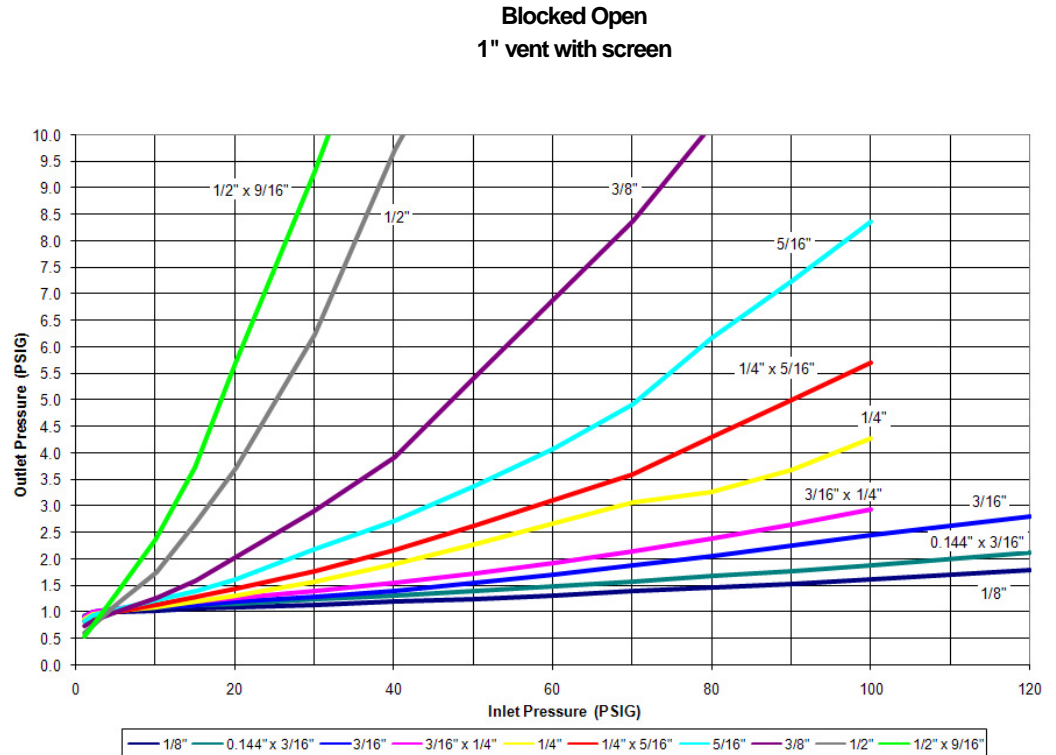

B57R PERFORMANCE CURVES

1 PSIG Set Point

Manufacturer	Itron
Type and Model	B57RHP
Regulator	
Inlet Size	3/4"
Outlet Size	1"
Spring Color	Red/Gray
Orifice Size	3/16"

Set point 7.0" w.c. with 40 PSIG inlet @5 0 SCFH. All test results are reported at a base of 14.7 PSIA and 60°F.

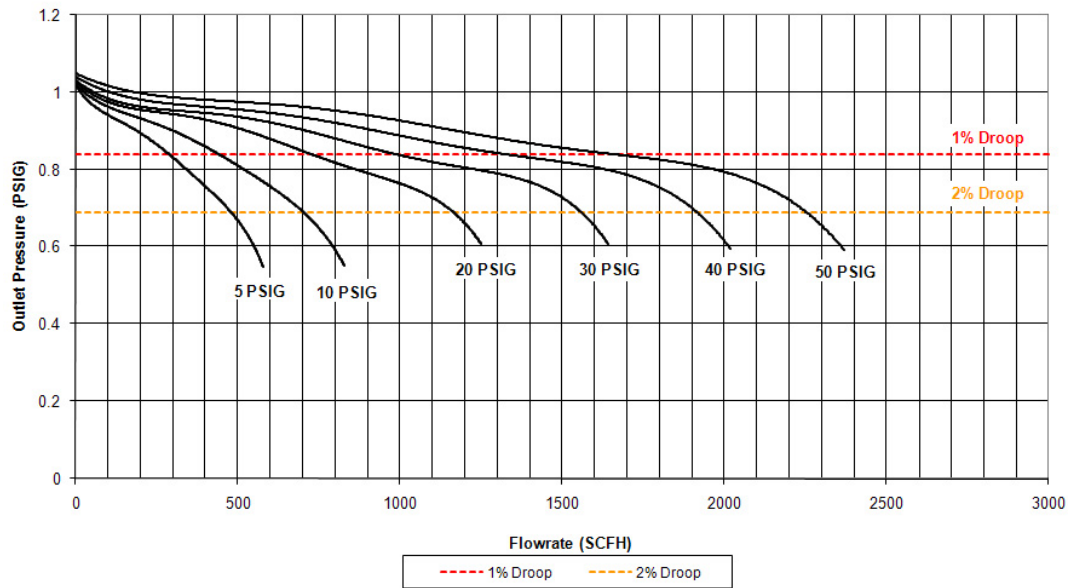

B57 SERIES RESIDENTIAL REGULATOR, MODELS N AND R

2 PSIG Capacity Table (1% Absolute Droop*) 3/4" x 3/4" Valve Body

Capacities in SCFH of 0.6 S.G. gas; base conditions of 14.7 PSIA and 60° F.

Typical Capacity Info.		Orifice Size										
		1/8"	0.144" x 3/16"	3/16"	3/16" x 1/4"	1/4"	1/4" x 5/16"	5/16"	3/8"	1/2"	1/2" x 9/16"	
Manufacturer	Itron	3	60	80	125	160	170	180	190	205	270	320
Type and model	B57RHP	5	100	170	190	260	280	290	300	325	395	490
Regulator		10	170	270	280	400	420	450	460	490	500	680
Inlet size:	3/4"	20	270	405	450	580	600	620	620	680	710	780
Outlet size	3/4"	30	350	550	540	690	710	710	715	775	810	830
Spring color	Red	40	480	670	660	750	750	860	875	900	875	900
Position	5	50	520	760	780	810	870	920	970	980		
		60	630	770	860	880	955	990	1015	1055		
		70	705	825	900	930	1020	1050	1050			
		80	750	900	920	970	1040	1070	1070			
		90	810	995	1015	1100	1130	1130	1130			
		100	850	1020	1070	1140	1180	1180	1180			
		120	900	1090	1235	1300	1325					
		125	1055	1265	1350	1400	1460					

Inlet Effect (PSIG) ^A	0.07	0.07	0.08	0.08	0.08	0.08	0.11	0.11	0.13	0.13
Lock Up (PSIG) ^B	0.01	0.02	0.02	0.03	0.03	0.04	0.05	0.05	0.07	0.09

Notes:

A. Change in outlet pressure for 10 PSIG inlet pressure change.

B. Outlet pressure increase required for lock up.

*Individual regulator performance may vary from data shown.

 Do not operate orifice in shaded inlet pressure area.

 Capacity in black outline generated with White Spring.

Capacity Table (2% Absolute Droop*) 3/4" x 3/4" Valve Body

Capacities in SCFH of 0.6 S.G. gas; base conditions of 14.7 PSIA and 60° F.

Typical Capacity Info.	
Manufacturer	Itron
Type and model	B57RHP
Regulator	
Inlet size	3/4"
Outlet size	3/4"
Spring color	Red
Position	5

Inlet Pressure PSIG	Orifice Size									
	1/8"	0.144" x 3/16"	3/16"	3/16" x 1/4"	1/4"	1/4" x 5/16"	5/16"	3/8"	1/2"	1/2" x 9/16"
3	90	200	290	310	350	380	400	425	620	625
5	145	320	340	450	460	540	555	625	815	925
10	320	480	520	600	690	790	815	900	1090	1350
20	480	720	750	800	1015	1090	1120	1300	1410	1710
30	630	740	990	1125	1160	1300	1325	1480	1620	1800
40	790	1150	1200	1315	1400	1490	1520	1610	1680	1960
50	950	1300	1390	1580	1600	1720	1775	1900		
60	1060	1410	1520	1710	1730	1835	1860	2000		
70	1220	1560	1670	1765	1790	1915	1930			
80	1340	1650	1725	1825	1870	1975	2000			
90	1385	1760	1820	1900	1940	2030	2050			
100	1515	1830	1860	1930	1985	2080	2100			
120	1665	1850	1890	2030	2050					
125	1880	1930	2000	2135	2250					

Inlet Effect (PSIG) ^A	0.07	0.07	0.08	0.08	0.08	0.08	0.11	0.11	0.13	0.13
Lock Up (PSIG) ^B	0.01	0.02	0.02	0.03	0.03	0.04	0.05	0.05	0.07	0.09

Notes:

A. Change in outlet pressure for 10 PSIG inlet pressure change.

B. Outlet pressure increase required for lock up.

*Individual regulator performance may vary from data shown.

Do not operate orifice in shaded inlet pressure area.

Capacities in black outline generated with White Spring.

B57 SERIES RESIDENTIAL REGULATOR, MODELS N AND R

2 PSIG Capacity Table (1% Absolute Droop*) 3/4" x 1" and 1" x 1" Valve Body

Capacities in SCFH of 0.6 S.G. gas; base conditions of 14.7 PSIA and 60° F.

Inlet Pressure PSIG		Orifice Size									
		1/8"	0.144" x 3/16"	3/16"	3/16" x 1/4"	1/4"	1/4" x 5/16"	5/16"	3/8"	1/2"	1/2" x 9/16"
3	45	80	150	180	200	210	240	250	300	380	
5	55	200	210	275	285	300	310	350	460	540	
10	200	300	310	445	460	470	490	560	625	800	
20	325	470	480	650	665	680	700	840	925	1100	
30	410	625	650	925	870	900	910	1010	1260	1540	
40	525	750	850	990	1000	1025	1040	1100	1140	1380	
50	625	890	980	1115	1150	1180	1280	1550			
60	700	960	1170	1200	1235	1250	1290	1680			
70	790	1120	1360	1400	1430	1465	1605				
80	900	1165	1400	1430	1460	1585	1620				
90	1025	1205	1510	1550	1580	1600	1630				
100	1155	1340	1680	1705	1890	1900	1925				
120	1400	1465	1745	1900	1930						
125	1430	1650	2020	2080	2100						

Inlet effect (PSIG) ^A	0.08	0.08	0.08	0.09	0.10	0.10	0.10	0.11	0.11	0.12
Lock Up (PSIG) ^B	0.02	0.03	0.03	0.03	0.04	0.04	0.05	0.06	0.07	0.08

Notes:

A. Change in outlet pressure for 10 PSIG inlet pressure change.

B. Outlet pressure increase required for lock up.

*Individual regulator performance may vary from data shown.

 Do not operate orifice in shaded inlet pressure area.

 Capacity in black outline generated with White Spring.

Capacity Table (2% Absolute Droop*) 3/4" x 1" and 1" x 1" Valve Body

Capacities in SCFH of 0.6 S.G. gas; base conditions of 14.7 PSIA and 60° F.

Typical Capacity Info.

Type and model	B57RHP
Regulator	
Inlet size	3/4"
Outlet size	1"
Spring color	Red
Position	5

Inlet Pressure PSIG	Orifice Size									
	1/8"	0.144" x 3/16"	3/16"	3/16" x 1/4"	1/4"	1/4" x 5/16"	5/16"	3/8"	1/2"	1/2" x 9/16"
3	80	200	210	310	325	390	410	460	560	710
5	190	325	350	475	490	580	590	650	870	1050
10	320	510	550	745	760	850	890	1025	1320	1590
20	520	800	890	1175	1200	1425	1440	1640	1920	2155
30	690	1025	1180	1550	1580	1800	1825	2040	2380	2500
40	860	1260	1500	1860	1925	2000	2025	2325	2500	2500
50	1020	1490	1740	2150	2245	2335	2350	2500		
60	1170	1700	2080	2410	2500	2500	2500	2500		
70	1335	1945	2280	2500	2500	2500	2500			
80	1505	2145	2500	2500	2500	2500	2500			
90	1640	2290	2500	2500	2500	2500	2500			
100	1860	2470	2500	2500	2500	2500	2500			
120	2190	2500	2500	2500	2500					
125	2280	2500	2500	2500	2500					

Inlet Effect ^A (PSIG)	0.08	0.08	0.08	0.09	0.10	0.10	0.10	0.11	0.11	0.12
Lock Up ^B (PSIG)	0.02	0.03	0.03	0.03	0.04	0.04	0.05	0.06	0.07	0.08

Notes:

A. Change in outlet pressure for 10 PSIG inlet pressure change.

B. Outlet pressure increase required for lock up.

*Individual regulator performance may vary from data shown.

 Do not operate orifice in shaded inlet pressure area.

 Capacities in black outline generated with White Spring.

B57 SERIES RESIDENTIAL REGULATOR, MODELS N AND R

2 PSIG Capacity Table (1% Absolute Droop*) 3/4" x 1-1/4", 1" x 1-1/4", & 1-1/4" x 1-1/4" Valve Body

Capacities in SCFH of 0.6 S.G. gas; base conditions of 14.7 PSIA and 60° F.

Typical Capacity Info.	
Manufacturer	Itron
Type and model	B57RH
Regulator	
Inlet size	1-1/4"
Outlet size	1-1/4"
Spring color	White
Position	5

Inlet Pressure PSIG	Orifice Size									
	1/8"	0.144" x 3/16"	3/16"	3/16" x 1/4"	1/4"	1/4" x 5/16"	5/16"	3/8"	1/2"	1/2" x 9/16"
3	65	110	180	190	250	270	260	280	380	480
5	180	240	250	380	325	390	410	480	625	740
10	240	380	400	590	560	680	690	725	980	1140
20	425	600	660	940	920	1100	1110	1250	1610	1740
30	590	825	900	1280	1280	1490	1525	1625	2025	2210
40	725	1010	1190	1520	1690	1840	1850	2160	2500	2500
50	900	1190	1470	1925	2025	2255	2340	2360		
60	1010	1425	1610	2225	2380	2500	2500	2500		
70	1285	1615	1990	2500	2500	2500	2500			
80	1300	1840	2300	2500	2500	2500	2500			
90	1465	1995	2465	2500	2500	2500	2500			
100	1675	2235	2500	2500	2500	2500	2500			
120	1945	2465	2500	2500	2500					
125	2050	2500	2500	2500	2500					

Inlet Effect (PSIG) ^A	0.04	0.04	0.04	0.04	0.04	0.04	0.05	0.05	0.07	0.07
Lock Up (PSIG) ^B	0.02	0.02	0.02	0.03	0.03	0.04	0.04	0.04	0.05	0.07

Notes:

A. Change in outlet pressure for 10 PSIG inlet pressure change.

B. Outlet pressure increase required for lock up.

*Individual regulator performance may vary from data shown.

 Do not operate orifice in shaded inlet pressure area.

Capacity Table (2% Absolute Droop*) 3/4" x 1-1/4", 1" x 1-1/4", & 1-1/4" x 1-1/4" Valve Body

Capacities in SCFH of 0.6 S.G. gas; base conditions of 14.7 PSIA and 60° F.

Typical Capacity Info.		Orifice Size										
		Inlet Pressure PSIG	1/8"	0.144" x 3/16"	3/16"	3/16" x 1/4"	1/4"	1/4" x 5/16"	5/16"	3/8"	1/2"	1/2" x 9/16"
Manufacturer	Itron	3	90	250	310	325	390	430	450	520	725	900
Type and model	B57RH	5	225	360	380	540	560	710	740	860	1125	1270
Regulator		10	370	560	660	880	925	1170	1240	1350	1760	2140
Inlet size	1-1/4"	20	590	780	1090	1270	1550	1940	2050	2260	2500	2500
Outlet size	1-1/4"	30	800	1010	1480	1620	2120	2500	2500	2500	2500	2500
Spring color	White	40	980	1240	1870	2000	2500	2500	2500	2500	2500	2500
Position	5	50	1150	1480	2225	2355	2500	2500	2500	2500		
		60	1310	1720	2500	2500	2500	2500	2500	2500		
		70	1500	1945	2500	2500	2500	2500	2500	2500		
		80	1675	2170	2500	2500	2500	2500	2500	2500		
		90	1820	2375	2500	2500	2500	2500	2500	2500		
		100	2025	2500	2500	2500	2500	2500	2500	2500		
		120	2390	2500	2500	2500	2500	2500	2500	2500		
		125	2500	2500	2500	2500	2500	2500	2500	2500		

Inlet Effect (PSIG) ^A	0.04	0.04	0.04	0.04	0.04	0.04	0.04	0.05	0.05	0.07	0.07
Lock Up (PSIG) ^B	0.02	0.02	0.02	0.03	0.03	0.04	0.04	0.04	0.04	0.05	0.07

Notes:

A. Change in outlet pressure for 10 PSIG inlet pressure change.

B. Outlet pressure increase required for lock up.

*Individual regulator performance may vary from data shown.

 Do not operate orifice in shaded inlet pressure area.

B57 RELIEF CURVES

2 PSIG Set Point

Manufacturer	Itron
Type and Model	B57RHP
Regulator	
Inlet Size	3/4"
Outlet Size	1"
Spring Color	Red
Vent Size	3/4"
Position	5

Set point 7.0" w.c. with 40 PSIG inlet @ 50 SCFH. All test results are reported at a base of 14.7 PSIA and 60°F.

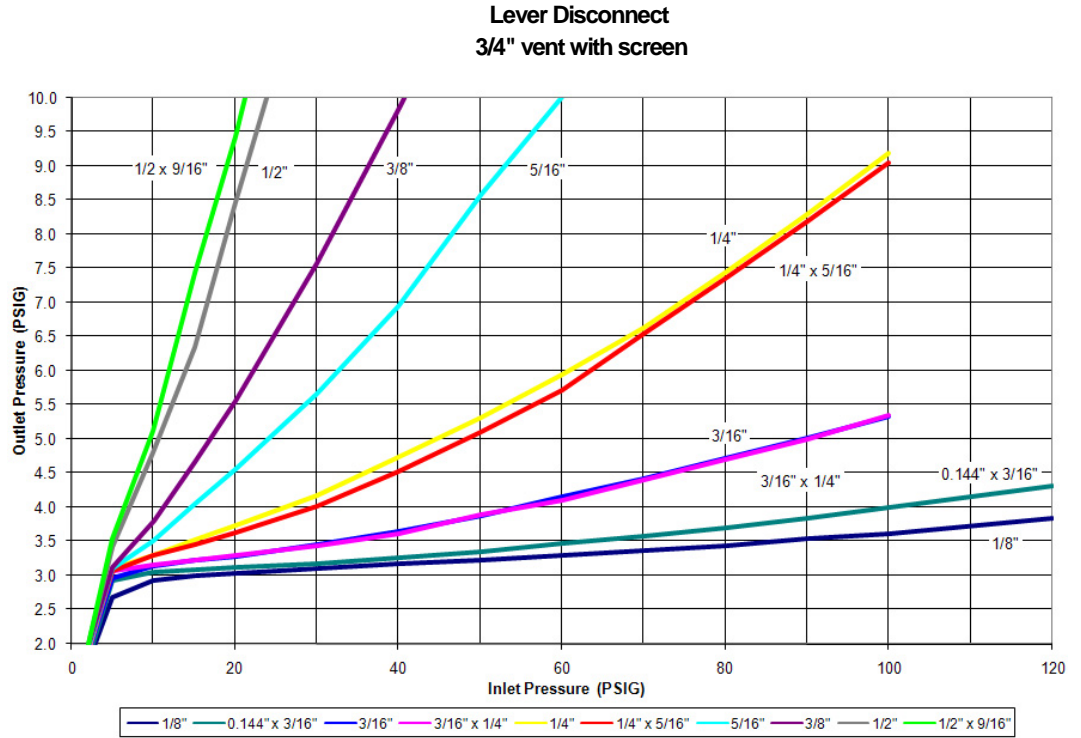

B57 RELIEF CURVES

2 PSIG Set Point

Manufacturer	Itron
Type and Model	B57RHP
Regulator	
Inlet Size	3/4"
Outlet Size	1"
Spring Color	Red
Vent Size	1"
Position	5

Set point 7.0" w.c. with 40 PSIG inlet @ 50 SCFH. All test results are reported at a base of 14.7 PSIA and 60°F.

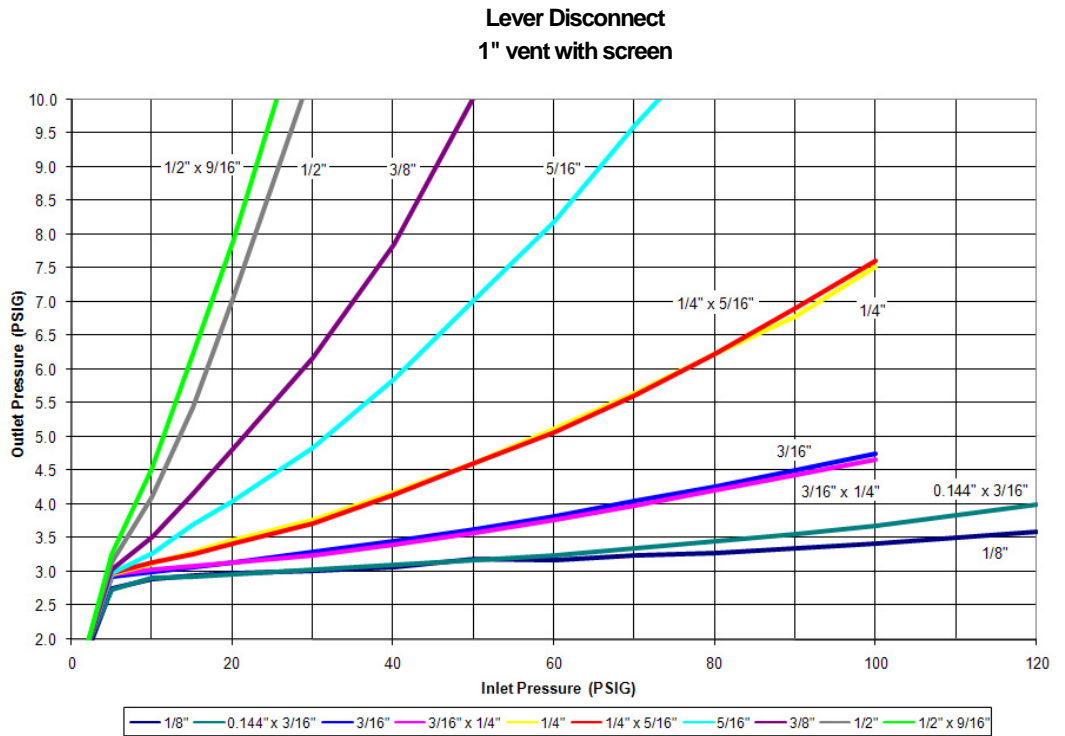

B57 RELIEF CURVES

2 PSIG Set Point

Manufacturer	Itron
Type and Model	B57RHP
Inlet Size	3/4"
Outlet Size	1"
Spring Color	Red
Vent Size	3/4"
Position	5

Set point 7.0" w.c. with 40 PSIG inlet @50 SCFH. All test results are reported at a base of 14.7 PSIA and 60°F.

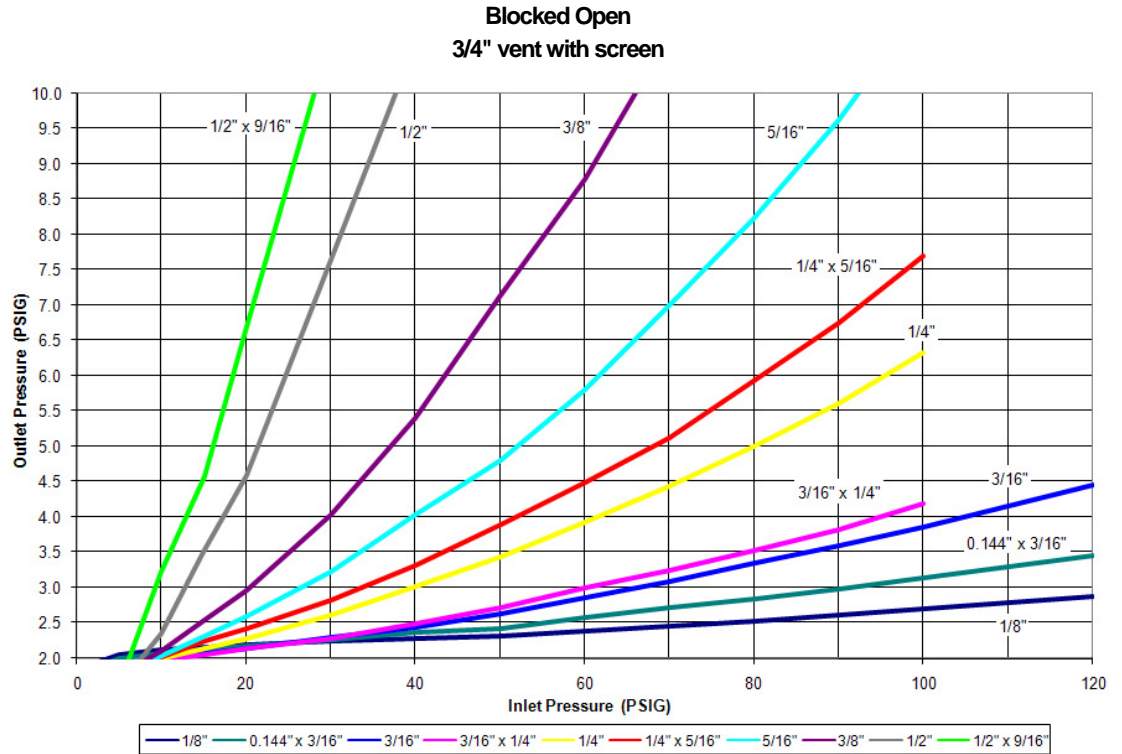

B57 RELIEF CURVES

2 PSIG Set Point

Manufacturer	Itron
Type and Model	B57RHP
Inlet Size	3/4"
Outlet Size	1"
Spring Color	Red
Vent Size	1"
Position	5

Set point 7.0" w.c. with 40 PSIG inlet @ 50 SCFH. All test results are reported at a base of 14.7 PSIA and 60°F.

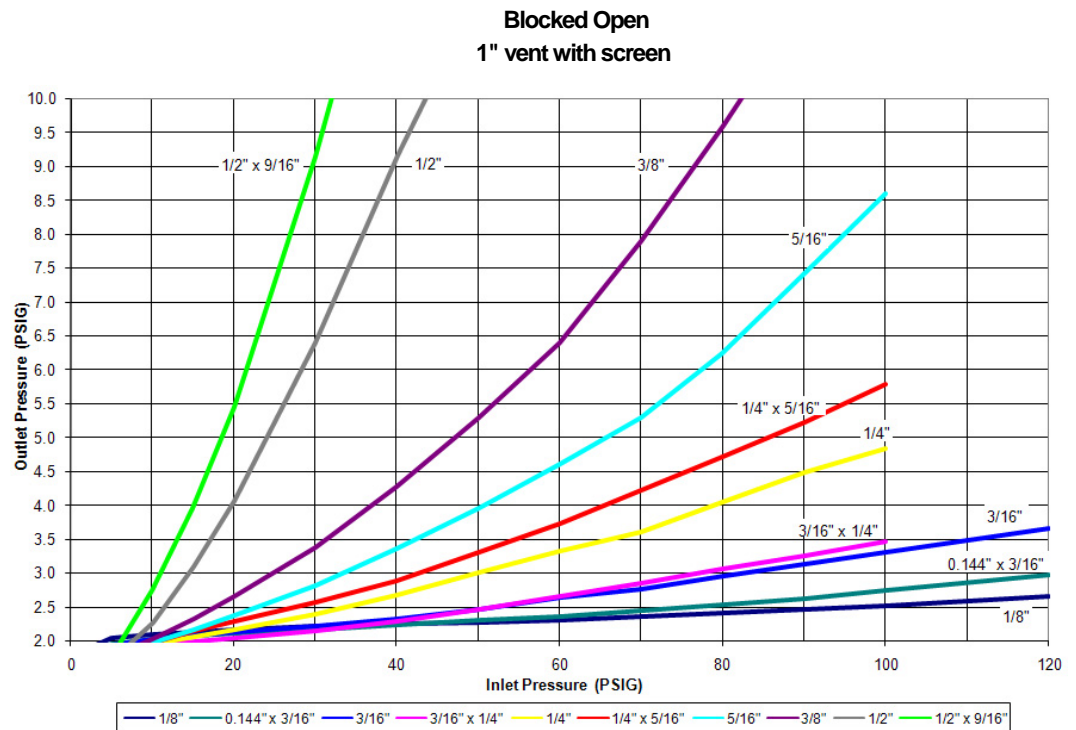

B57R PERFORMANCE CURVES

2 PSIG Set Point

Manufacturer	Itron
Type and Model	B57RHP
Inlet Size	3/4"
Outlet Size	1"
Spring Color	Red
Orifice Size	3/16"

Set point 7.0" w.c. with 40 PSIG inlet @ 50 SCFH. All test results are reported at a base of 14.7 PSIA and 60°F.

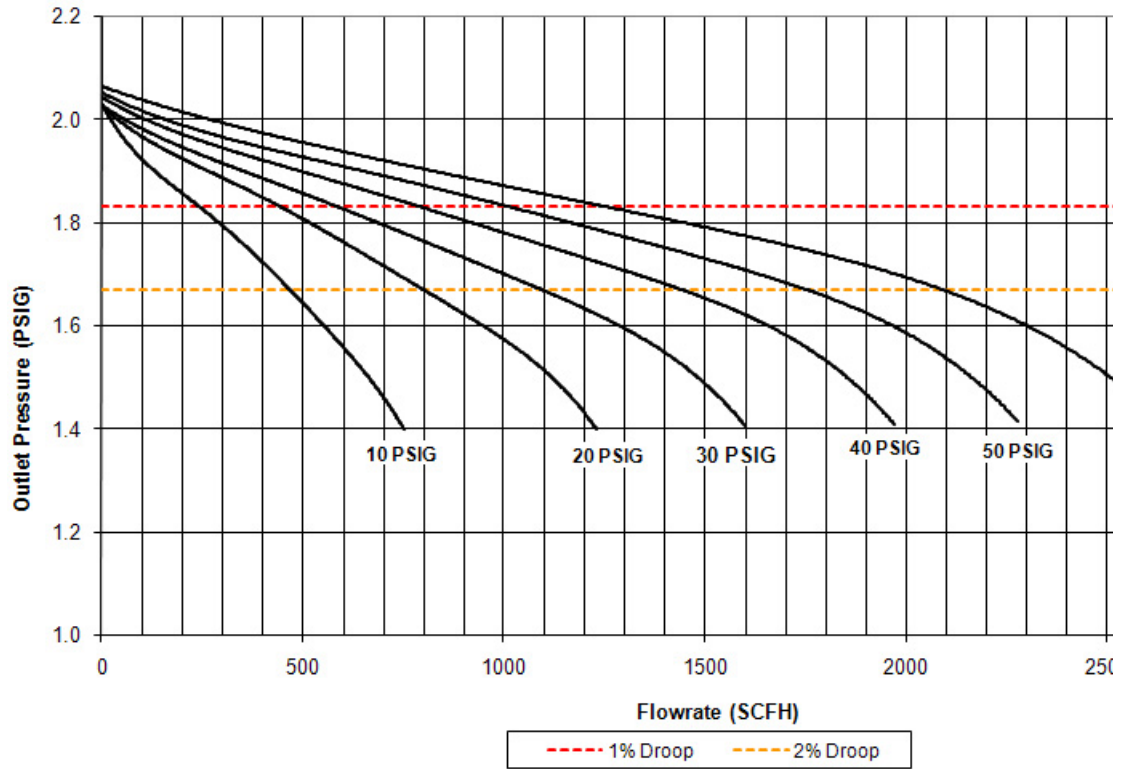

ASSEMBLY POSITIONS

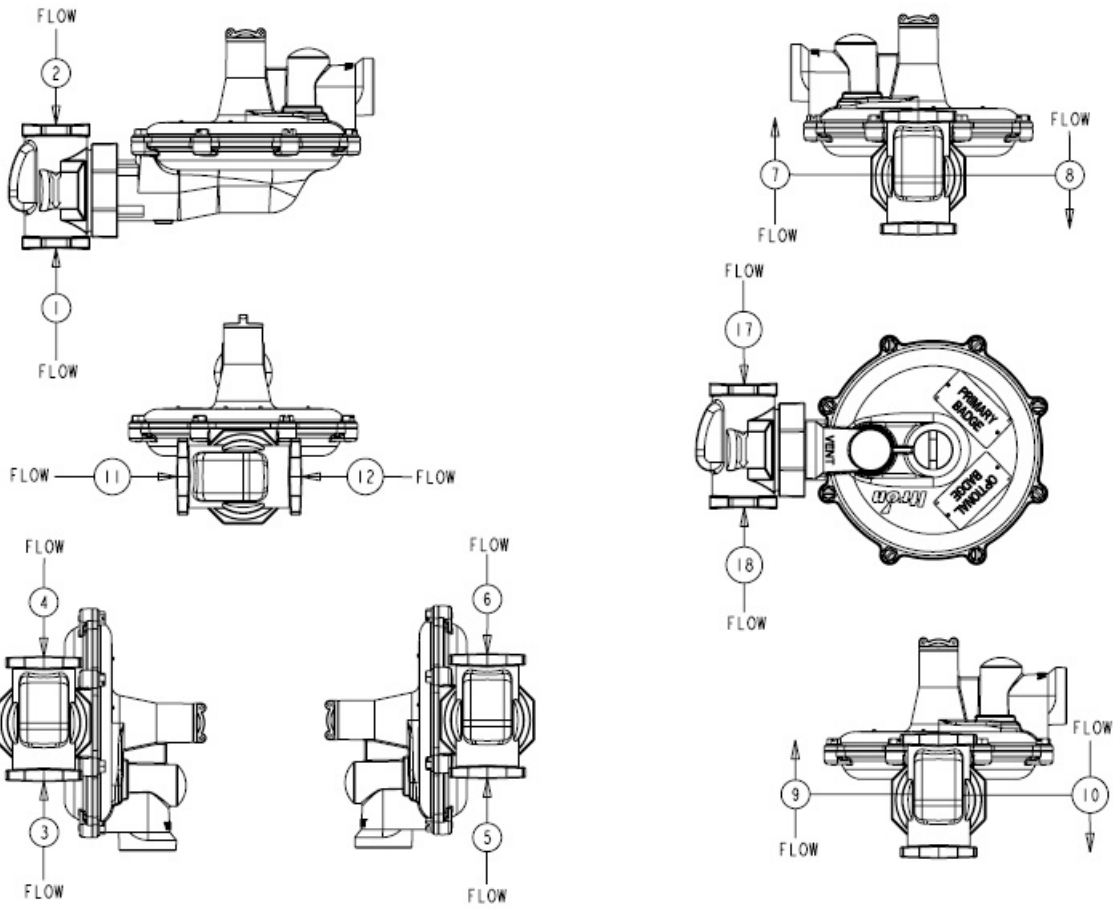

B57 PARTS DIAGRAM

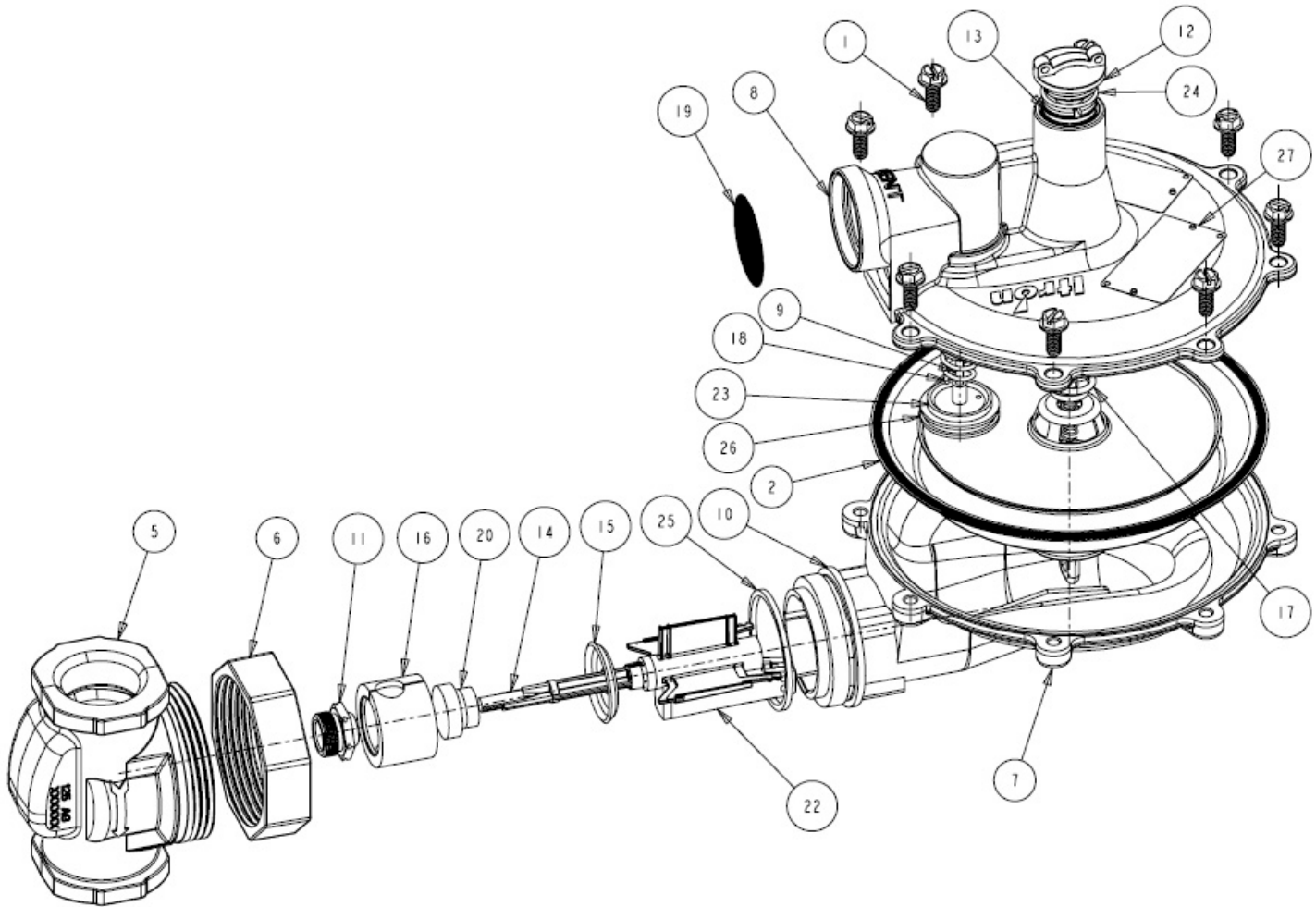

B57 PARTS LIST

Item Number	Part Number	Quantity Required per Regulator			Description
		N	R	HP	
1	010323	8	8	8	Case screw (Hex head) 1/4-20 x 3/4
2	720075		1	1	Diaphragm assembly -R
	720077	1		1	Diaphragm assembly -N
5		1	1	1	Valve body, straight, please specify size
	750055-PC				1/2" x 1/2"
	750056-PC				3/4" x 3/4"
	750059-PC				3/4" x 1"
	750106-PC				3/4" x 1-1/4"
	750058-PC				1" x 1"
	750108-PC				1" x 1-1/4"
	750129-PC				1-1/4" x 1-1/4"
6	751971	1	1	1	Union nut, 2-3/4"
7	752145	1	1	1	Lower diaphragm case assembly
					5.5:1 ratio, 3/4" and 1" valve bodies
					4:1 ratio, 1-1/4" valve bodies

Item Number	Part Number	Quantity Required per Regulator			Description
		N	R	HP	
8		1	1	1	Upper diaphragm case
	753189				Vent, 3/4" pipe
	753190				Vent, 3/4" pipe -HP
	753250				Vent, 1" pipe
	753251				Vent, 1" pipe -HP
9	75483401	1	1	1	Pin vent valve, 1" vent
10	755725	1	1	1	Retaining ring
11		1	1	1	Orifice, aluminum, please specify size
	757213				1/8" diameter
	757313				0.144" x 3/16" diameter
	757219				3/16" diameter
	757331				3/16" x 1/4" diameter
	757225				1/4" diameter
	757337				1/4" x 5/16" diameter
	757231				5/16" diameter
	757237				3/8" diameter
	757451				1/2" diameter
	75747401				1/2" x 9/16" diameter
12	760058	1	1	1	Seal cap
13	760215	1	1		Adjustment screw, Celcon
	760217			1	Adjustment screw, aluminum
14	761245	1	1	1	Valve stem
15	761715	1	1	1	Deflector ring
16	761753	1	1	1	Loading ring
17		1	1		Adjustment spring, please specify
	762111				Brown
	762117				Dark green
	762139				Gray
	762119				Light green
	762123				Black
	762127				Blue
	762129				Silver
				1	HP adjustment spring, please specify
	762025				Red/gray
	762131				Yellow
	762135				Red
	762137				White
18	762651	1	1	1	Vent spring
19	762933	1	1	1	Vent screen, 1" and 3/4" vent
20	765011	1	1	1	Buna-N valve seat
	765012	1	1	1	Silicone valve seat
22		1	1	1	Valve stem insert assembly
	765155				4:1 Lever ratio, 1-1/4" valve bodies
	765156				5.5:1 Lever ratio, 3/4" & 1" valve bodies
23	765193	1	1	1	Vent valve disc
24	765503	1	1	1	Seal cap O-ring
25	765605	1	1	1	Valve body gasket

Item Number	Part Number	Quantity Required per Regulator			Description
		N	R	HP	
26	765685	1	1	1	Vent valve seat
27	769250	1	1	1	Regulator badge(s)

Torque Specifications

Case screws	27-30 in. lbs.
Union nut	40-60 ft. lbs.
Orifice	450-500 in. lbs.

Special Tools

799051	Spring adjustment wrench
799017	Orifice socket

VENT LINES FOR REGULATORS

When constructing vent lines to be attached to regulators installed indoors, follow these basic rules:

- Never use pipe sizes smaller than the vent size; smaller pipe sizes restrict the gas flow. If a long gas run must be used, Itron advises increasing the pipe one nominal size every ten feet to keep the flow restriction as low as possible.
- Keep the vent line length as short as possible to minimize the restriction and reduce the vent's tendency to cause regulator pulsation.
- Support the vent pipe to eliminate strain on the regulator diaphragm case.
- Always point outdoor vent pipes in the downward position to reduce the possibility of rain, snow, sleet, and other moisture entering the pipe. Install a bug screen in the end of the pipe.
- Do not locate the vent line terminus near windows, fans, or other ventilation equipment. See the installation instructions furnished with the regulator.
- Adhere to all applicable codes and regulations.
- If your vent pipe causes regulator pulsation, consult your sales representative or manufacturer.
- Itron strongly recommends running a separate vent line for each regulator. Headers with various installed devices can cause regulator malfunction.

Caution Ensure the end of the vent line is away from ANY potential ignition sources. It is the installer's responsibility to ensure the vent line is exhausting to a safe environment.

INSTALLATION

Warning Itron does not endorse or warrant the completeness or accuracy of any third party regulator installation procedures or practices, unless otherwise provided in writing by Itron. Follow your company's standard operating procedures regarding the use of personal protection equipment (PPE). Adhere to guidelines issued by your company in addition to those given in this document when installing regulators.

- Remove all shipping plugs from the regulator inlet, outlet, and vent before installation.
- Verify the piping interior and regulator inlet and outlet are clean and free of dirt, pipe dope, and other debris. Dirt and other foreign materials entering the regulator can cause a loss of pressure control.
- Apply pipe joint sealant to the male pipe threads. Do not use pipe joint material on the regulator's female threads. Joint sealant could become lodged in the regulator and cause a loss of pressure control.
- Gas must flow through the regulator's valve body in the direction cast on the regulator body. Gas flowing in the wrong direction can overpressure and cause damage to the regulator.
- B57 regulator models can be mounted in a full 360° angle.
- When the regulator is installed OUTDOORS, the vent must always be positioned so that rain, snow, moisture or foreign particles cannot enter the vent opening. It is recommended that the vent be positioned to face downward so as to avoid entry of water or other matter which could interfere with the proper operation of the regulator. The vent should be located away from building eaves, window openings, building air intakes and above the expected snow level at the site. The vent opening should be inspected periodically to insure it does not become blocked by foreign material as outlined in DOT PHMSA-RSPA-2004-19856.
- When the regulator is installed INDOORS, the vent must be piped to the outside atmosphere while using the shortest length of pipe, the least number of elbows, and having as large a pipe diameter as the vent size or larger. USING VENT PIPE ANY SIZE SMALLER THAN THE VENT CONNECTION WILL LIMIT THE REGULATOR'S INTERNAL RELIEF VALVE CAPACITY. The outlet end of the pipe must be protected from moisture and the entrance of foreign particles. The regulator should be specified by the user with the size vent and pipe threads desired to make the vent pipe connection.

START-UP PROCEDURE

- a. Mount a pressure gauge downstream of the regulator to monitor the downstream pressure.
- b. With the downstream pressure valve closed, slowly open the inlet valve. The outlet pressure should rise to slightly more than the set-point.
- c. Verify there are no leaks and all connections are tight.
- d. The regulator was pre-set at the factory to match order specifications. If necessary, adjust the outlet pressure by removing the seal cap on the top of the spring housing and rotating the ferrule or adjustment screw inside the spring housing. Adjusting the outlet pressure requires either a ratchet with a socket and an extension or a large flat-head screwdriver. With a small amount of gas flowing through the regulator:
- e. Rotate the adjustment screw clockwise to raise the outlet pressure.
- f. Rotate the adjustment screw counter-clockwise to lower the outlet pressure.
- g. Replace the seal cap and check for leaks after the desired outlet pressure is achieved.

The regulator is ready for operation.

SAFETY WARNING

This product, as of the date of manufacture, is designed and tested to conform to all governmental and industry safety standards as they may apply to the manufacturer. The purchaser/user of this product must comply with all fire control, building codes, and other safety regulations governing the application, installation, operation, and general use of this regulator to avoid leaking gas hazards resulting from improper installation, startup or use of this product.

Itron strongly recommends installation by a qualified professional and periodic inspection of pressure regulators (inspections may be required by local applicable codes or regulations).

Inspections should include checking for gas quality, cycle numbers, external environmental changes, and operating conditions that impact wear on the regulator's moving parts. To ensure safe and efficient operation of this product, replace worn or damaged parts found during inspection.

LIMITED WARRANTY

Itron, Inc. 2111 North Molter Road Liberty Lake, WA 99019, warrants this gas product against defects in materials and workmanship for the earlier of one (1) year from the date the product is shipped by Itron or a period of one year from the date the product is installed by Itron at the original purchaser's site. During such one-year period, provided that the original purchaser continues to own the product, Itron will, at its sole option, repair any defects, replace the product or repay the purchase price.

» This warranty will be void if the purchaser fails to observe the procedures for installation, operation or service of the product as set forth in the Operating Manual and Specifications for the product or if the defect is caused by tampering, physical abuse or misuse of the product.

- » ITRON SPECIFICALLY DISCLAIMS ALL IMPLIED WARRANTIES INCLUDING THOSE OF MERCHANTABILITY OR OF FITNESS FOR A PARTICULAR PURPOSE. UNDER NO CIRCUMSTANCES WILL ITRON BE LIABLE FOR INCIDENTAL OR CONSEQUENTIAL DAMAGES OF ANY KIND WHATSOEVER.
- » Itron's liability for any claim of any kind, including negligence and breach of warranty for the sale and use of any product covered by or furnished, shall in no case exceed the price allocable to the product or part thereof which gives rise to the claim.
- » In the event of a malfunction of the product, consult your Itron Service Representative or Itron Inc., 2111 North Molter Road Liberty Lake, WA 99019. See Itron Terms and Conditions of Sale for the full and complete terms of the Limited Warranty.

ORDERING INFORMATION

1. Inlet and outlet connection size and type
2. Model number
3. Outlet pressure desired
4. Inlet pressure range
5. Type of gas and maximum capacity required
6. Assembly position number (see diagram above)
7. Vent size
8. Special requirements such as tagging, pipe plug tap, seal wire, etc.



Join us in creating a more **resourceful world**.
To learn more visit **itron.com**

While Itron strives to make the content of its marketing materials as timely and accurate as possible, Itron makes no claims, promises, or guarantees about the accuracy, completeness, or adequacy of, and expressly disclaims liability for errors and omissions in, such materials. No warranty of any kind, implied, expressed, or statutory, including but not limited to the warranties of non-infringement of third party rights, title, merchantability, and fitness for a particular purpose, is given with respect to the content of these marketing materials. © Copyright 2018 Itron. All rights reserved. 100998SP-05 09/18

CORPORATE HQ

2111 North Molter Road
Liberty Lake, WA 99019 USA

Phone: 1.800.635.5461

Fax: 1.509.891.3355